

RoHS 2.0

REV.	ECN NO.	DESCRIPTION	DATE	DESIGN
A1.	/.	重新核对图面	21.01.13	LiHui
A2.	/.	HD	22.08.11	LZR

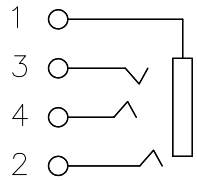

电气性能

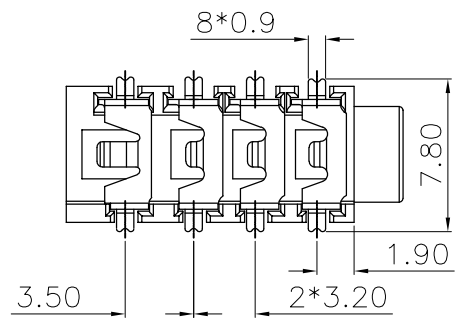
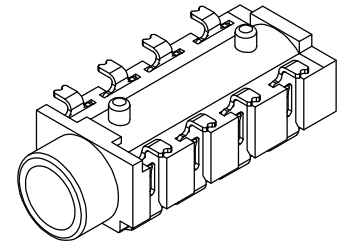

3D VIEW

NOTES:

- MATERIAL:
 - HOUSING: PA9T, COLOR IS BLACK;
 - CONTACT: PHOSPHOR COPPER (C5191, T=0.25);
- ELECTRICAL:
 - VOLTAGE RATING: 30 VAC RMS;
 - CURRENT RATING: 0.5 AMP;
 - CONTACT RESISTANCE: 30MILLIOHMS MAX.;
 - WITHSTAND VOLTAGE: 500 VAC RMS
50(60)Hz, 1MIN.;
 - INSULATION RESISTANCE: 100MEGOHMS MIN
@500V DC;
- MECHANICAL:
 - MATING FORCE: 5~25N;
 - UNMATING FORCE: 5~25N;
 - OPERATING LIFE: 5000 CYCLES;
- PLATING:
 - TERMINAL:
NI PLATING OVER ALL,
TIN PLATING ON SOLDER AREA,
- ENVIRONMENTAL:
 - STORAGE TEMPERATURE RANGE: -40°C~+85°C;
 - OPERATION TEMPERATURE RANGE: -25°C~+70°C;
- SALT SPRAY TEST: 8H (EXCLUDING RIVETED BENDS)

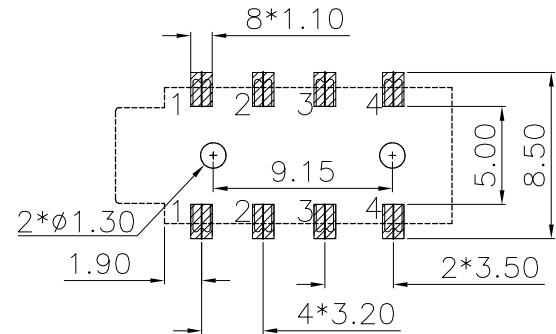
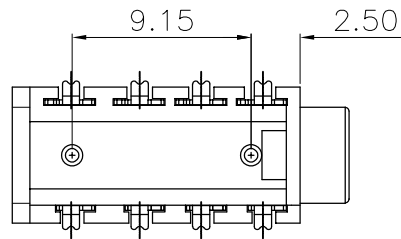
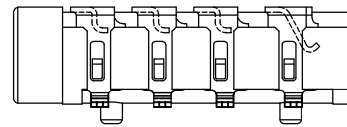
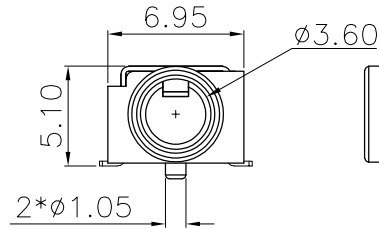
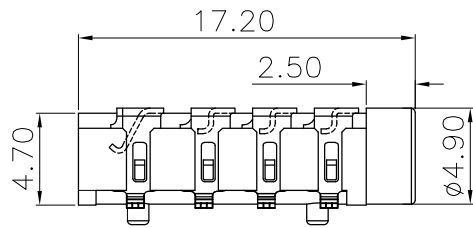

RECOMMEND PCB LAYOUT(±0.05)

B	端子	C5191	焊料区镀锡 全周镀镍	
A	底座	PA9T	黑色	
序号	品名	材质	电镀/颜色	备注

深圳市虹成电子有限公司

UNLESS OTHERWISE, GENERAL TOLERANCE: X.xxx ±0.10 X.xx ±0.20 X.x ±0.30	NAME: 313耳机四节贴片黑色		P/N: HC-PJ-313E8-B-SMT			
	THIRD ANGLE PROJECTION 		UNIT: mm	SCALE: 1:1	SIZE: A4	SHEET: 1/1
ANGULAR: X.xx' ±1' X.x' ±3' X.' ±5'	DRAWN:		CHECKED:		APPROVED	

X-ON Electronics

Largest Supplier of Electrical and Electronic Components

Click to view similar products for [Phone Connectors](#) category:

Click to view products by [Hong Cheng](#) manufacturer:

Other Similar products are found below :

[R4F](#) [14412GX](#) [E12BPKG](#) [MT333X](#) [171-3302-EX](#) [NC3MG-V](#) [NP2RX-AU-SILENT-D](#) [JM2PB-AU BULK](#) [S2674](#) [280L](#) [RJ5VI-S](#) [TM1R-AU](#) [TM2PJ-AU](#) [TM2PJ-AU BULK](#) [TS3PBJ-AU](#) [TS3PBMJ-AU](#) [MP-101](#) [54B](#) [T10711](#) [MT334F](#) [NJ3FP6F-P](#) [NPX-PROMO](#) [JS3PB-AU BULK](#) [XMT332A](#) [114BPCSX](#) [CMT334B](#) [AA0-A4830-A00](#) [PJ-218](#) [PJ-320-3P SMT](#) [PJ-321A](#) [PJ-393-8P](#) [KH-PJ-327D-SMT](#) [PJ-320D](#) [PJ-3106M](#) [PJ-376](#) [PJ-368](#) [PJ-624](#) [PJ-339](#) [PJ-3200B](#) [RCJ-017](#) [PJ-307B-1.3-01](#) [PJ-324](#) [PJ-324M](#) [PJ-313D](#) [PJ-313](#) [PJ-227](#) [PJ-3106AC1](#) [PJ-3505A](#) [PJ-321](#) [KH-PJ-307-5P](#)