

# SPECIFICATIONS

Current Rating: 3Amps  
 Insulation Resistance: 1000MΩ Min  
 Contact Resistance: 20mΩ Max  
 Withstanding Voltage: AC 1000V  
 Operation Temperature: -40° to +105°  
 Contact Material: Brass  
 Standard: PA6T  
 Insulator Material: Polyester  
 Contact Plating: Gold Flash  
 Max. Processing Temp: 240° C for 30-60 seconds  
 (260° C for 5 seconds)

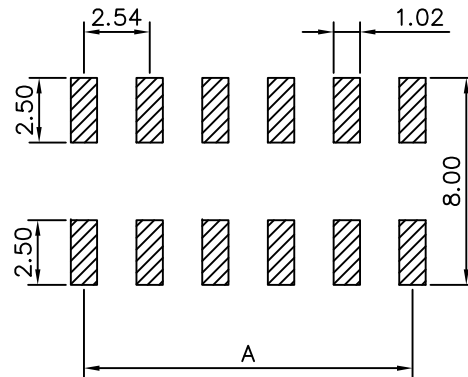
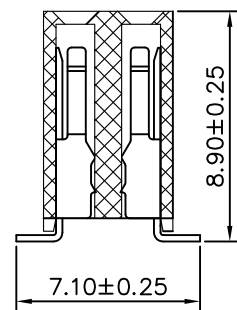
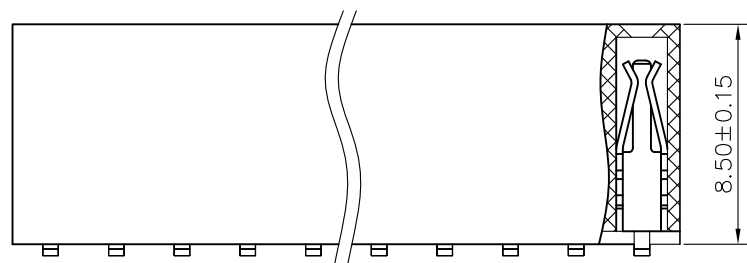
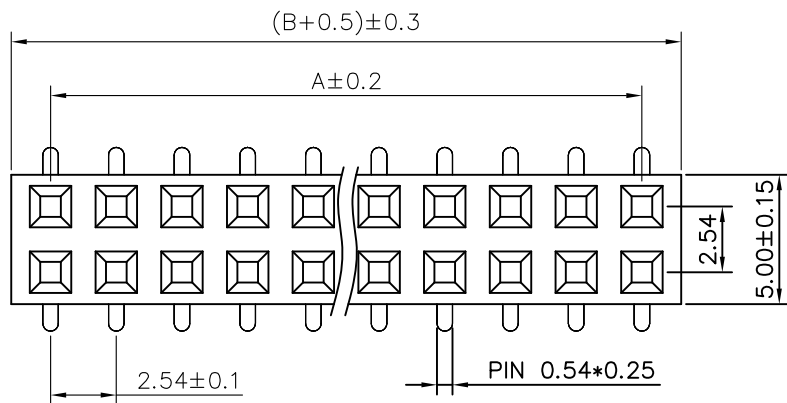

## RECOMMEND P. C. B LAYOUT

PCB TOLERANCE: ±0.05 (TOP VIEW)

# 深圳市虹成电子有限公司

UNLESS OTHERWISE SPECIFIED TOLERANCE

X : ±0.30 X° : ±5°  
 X.X : ±0.25 X.X° : ±1°  
 X.XX : ±0.20 X.XX° : ±0.5°

DRAWN NAME: 2.54FH H8.5 2xnPin SMT U型 PC7.1 PB8.9 6T

SIZE A4 SCALE N:1 PROUCT NO. HC-PM254-8.5H-2x17PS

REV A UNIT mm PROJECT PAGE 1/1

CHECKED: 陈超凡 2023/03/27 CHECKED: / / APPROVED: / /

No. of	DIM. A	DIM. B	No. of	DIM. A	DIM. B	No. of	DIM. A	DIM. B	No. of	DIM. A	DIM. B
1	0.00	2.54	11	25.40	27.94	21	50.80	53.34	31	76.20	78.74
2	2.54	5.08	12	27.94	30.48	22	53.34	55.88	32	78.74	81.28
3	5.08	7.62	13	30.48	33.02	23	55.88	58.42	33	81.28	83.82
4	7.62	10.16	14	33.02	35.56	24	58.42	60.96	34	83.82	86.36
5	10.16	12.70	15	35.56	38.10	25	60.96	63.50	35	86.36	88.90
6	12.70	15.24	16	38.10	40.64	26	63.50	66.04	36	88.90	91.44
7	15.24	17.78	17	40.64	43.18	27	66.04	68.58	37	91.44	93.98
8	17.78	20.32	18	43.18	45.72	28	68.58	71.12	38	93.98	96.52
9	20.32	22.86	19	45.72	48.26	29	71.12	73.66	39	96.52	99.06
10	22.86	25.40	20	48.26	50.80	30	73.66	76.20	40	99.06	101.60

## X-ON Electronics

Largest Supplier of Electrical and Electronic Components

*Click to view similar products for [Headers & Wire Housings](#) category:*

*Click to view products by [Hong Cheng](#) manufacturer:*

Other Similar products are found below :

[0015917161](#) [0022155065](#) [57102-F02-18ULF](#) [58102-G61-06LF](#) [582553-1](#) [01.001.5753.1](#) [0050291907](#) [02.125.8002.8](#) [609-3404](#) [61062-3](#)  
[CSU011177004](#) [622-0430](#) [622-3653LF](#) [63453-116](#) [636-1030](#) [636-1427](#) [636-3427](#) [636-4007](#) [641938-9](#) [65495-038](#) [65692-001LF](#) [65781-018](#)  
[65781-047](#) [65817-010LF](#) [65817-015LF](#) [67095-007LF](#) [67601157](#) [68631-112](#) [68645-018](#) [699319-000](#) [70.362.1628.0](#) [70-4210](#) [70-4226B](#) [70-](#)  
[4853B](#) [71.350.2428.0](#) [733-134](#) [733-162](#) [MHR-64-VUAL](#) [80.063.4001.1](#) [800-90-001-10-001000](#) [801-43-002-10-013000](#) [801-43-006-10-](#)  
[002000](#) [803-43-024-10-001000](#) [803-93-012-10-001000](#) [8-1437020-4](#) [819-22-004-30-001101](#) [820-22-006-30-001101](#) [820-22-008-30-001101](#)  
[821-22-002-10-001101](#) [821-22-003-10-002101](#)