

RoHS 2.0

PIN NUMBER	SIGNAL NAME
PIN 1	Vbus
PIN 2	D-
PIN 3	D+
PIN 4	GND
PIN 5	StdA_SSRX-
PIN 6	StdA_SSRX+
PIN 7	GND_DRAIN
PIN 8	StdA_SSTX-
PIN 9	StdA_SSTX+
SHELL	GND

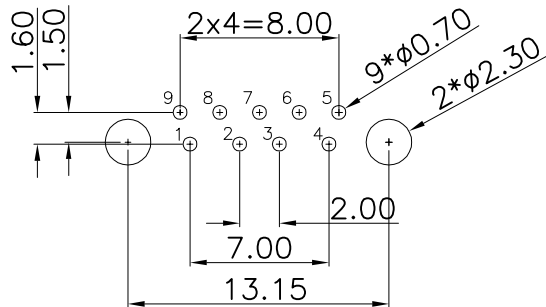
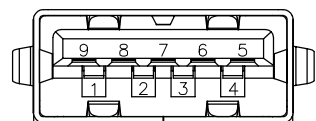
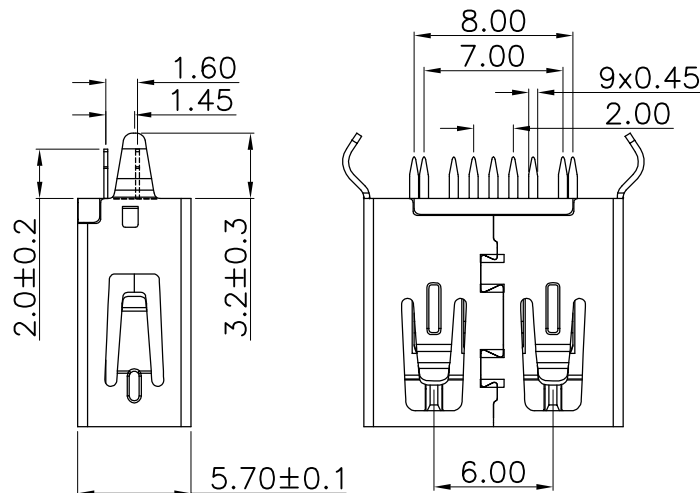
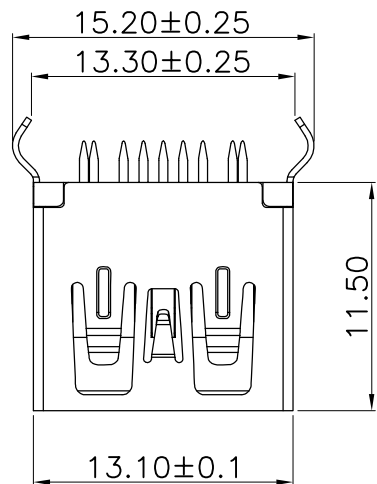
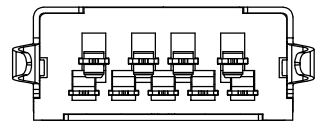
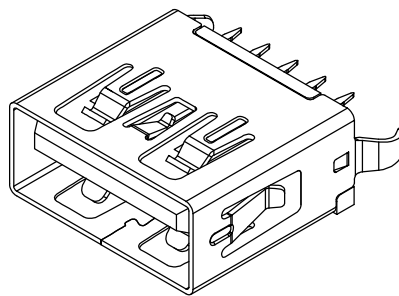

RECOMMENDER P. C. B. LAYOUT TOP VIEW
(COMPONENT SIDE TOLERANCE±0.05)

REV.	ECN NO.	DESCRIPTION	DATE	DESIGN
A0		新版发行	19/03/05	Yang
A1		重新核对图面	20/12/31	LiHui
		HD	22/07/08	LZR

NOTES:

- MATERIAL:
 - HOUSING: LCP ,COLOR IS BLUE,HIGH TEMPERATURE PLASTIC;
 - CONTACT: BRASS (H65 T=0.20&0.25mm);
 - SHELL: COLD ROLLED IRON (SPCC T=0.30mm);
- ELECTRICAL:
 - VOLTAGE RATING: 30V DC ;
 - CURRENT RATING: 1.5A ;
 - CONTACT RESISTANCE: 30MILLIOHMS MAX.;
 - WITHSTAND VOLTAGE: 100 VAC RMS 50(60)Hz,1MIN.;
 - INSULATION RESISTANCE: 100MEGOHMS MIN @500V DC;
- MECHANICAL:
 - MATING FORCE: 35N MAX.;
 - UNMATING FORCE: 5~35N ;
 - OPERATING LIFE: 1500 CYCLES MIN.;
- PLATING:
 - TERMINAL:
 - NI PLATING OVER ALL,
 - Tin PLATING ON SOLDER AREA,
 - Au 1U" ON CONTACT AREA;
 - SHELL: NI PLATING OVER ALL;
- ENVIRONMENTAL:
 - STORAGE TEMPERATURE RANGE: -40°C~+85°C;
 - OPERATION TEMPERATURE RANGE: -25°C~+70°C;
 - SALT SPRAY TEST:24H(EXCLUDING RIVETED BENDS)

C	外壳	SPCC	镀镍
B	端子	黄铜H65	焊料区镀锡 接触区镀金(1U)
A	底座	LCP	蓝色

深圳市虹成电子有限公司

UNLESS OTHERWISE,
GENERAL TOLERANCE:

X.xxx ±0.10
X.xx ±0.20
X.x ±0.30

ANGULAR:

X.xx° ±1°
X.x° ±3°
X.° ±5°

NAME:

3.0 A母180° L11.5平口弯脚

I/N.

HC-USB3.0-L115-WP

DWG NO:

THIRD ANGLE PROJECTION

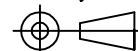

UNIT:

MM

SCALE

1:1

SIZE:

A4

SHEET:

1/1

REV.

A1

DRAWN:

CHECKED:

APPROVED:

X-ON Electronics

Largest Supplier of Electrical and Electronic Components

Click to view similar products for [USB Connectors](#) category:

Click to view products by [Hong Cheng](#) manufacturer:

Other Similar products are found below :

[950](#) [MUSBD11135](#) [17-200721](#) [217450-1](#) [KMBVX-TH-5S-B30](#) [KUSBX-AS2N-W](#) [KUSBX-SMT2AP1S-W30](#) [935](#) [957](#) [30-498-6](#) [SK-60A-2](#)
[1734082-1](#) [30-470](#) [30-489](#) [30-541](#) [A-USB A-2P-C](#) [MIKROE-1451](#) [USBFTVSCCG](#) [1-1734084-2](#) [10135326-001LF](#) [4198](#) [USB-A-D-VT](#)
[USB-A-S-RA-TSMT](#) [1310-1023-02](#) [690-024-633-031](#) [UB-20PMFP-LC7001](#) [17-200011](#) [UB-20AFMM-LL7A01](#) [1040870124](#) [CAP-](#)
[WCCMLPB1](#) [CAP-WCCMLPC1](#) [2274475-3](#) [UB-20BMFA-SL8001](#) [914-614A2025S10200](#) [USB3FTV7SAGF059](#) [ZX40-B-5S-1500-](#)
[STDA\(30\)](#) [GSB3116344HR](#) [USB3FTV2SAZNF459](#) [USB3FTV7SAZNF459](#) [U221-041N-1WVS62-F5D](#) [HYCW153-USBD05-500B](#)
[HYCW219-USBD05-075B](#) [HYCW148-USBD05-117B](#) [HYCW149-USBD05-740B](#) [HYCW204-USBD05-108B](#) [HYCW214-USBA04-113B](#)
[HYCW213-USBA04-113B](#) [UB-20AMFM-SL7A01](#) [KMMX-BSMT35S-1-B30TR](#) [2345986-1](#)