

RoHS 2.0

PIN NUMBER	SIGNAL NAME
PIN 1	Vbus
PIN 2	D-
PIN 3	D+
PIN 4	GND
PIN 5	StdA_SSRX-
PIN 6	StdA_SSRX+
PIN 7	GND_DRAIN
PIN 8	StdA_SSTX-
PIN 9	StdA_SSTX+
SHELL	GND

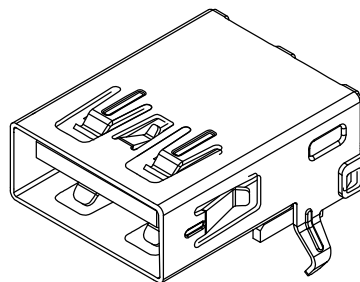

REV.	ECN NO.	DESCRIPTION	DATE	DESIGN
A1.	/.	重新核对图面	21.01.14	LiHui
		HD	22.05.28	LZR

NOTES:

- MATERIAL:
  - HOUSING: PBT ,COLOR IS BLUE;
  - CONTACT: BRASS (H65 T=0.20&0.25mm);
  - SHELL: COLD ROLLED IRON (SPCC T=0.30mm);
- ELECTRICAL:
  - VOLTAGE RATING: 30V DC ;
  - CURRENT RATING: 1.5A ;
  - CONTACT RESISTANCE: 30MILLIOHMS MAX.;
  - WITHSTAND VOLTAGE: 100V AC RMS 50(60)Hz,1MIN.;
  - INSULATION RESISTANCE: 100MEGOHMS MIN @500V DC;
- MECHANICAL:
  - MATING FORCE: 35N MAX.;
  - UNMATING FORCE: 5~35N ;
  - OPERATING LIFE: 1500 CYCLES MIN.;
- PLATING:
  - TERMINAL:
    - NI PLATING OVER ALL,
    - Tin PLATING ON SOLDER AREA,
    - Au 1U" ON CONTACT AREA;
  - SHELL: NI PLATING OVER ALL;
- ENVIRONMENTAL:
  - STORAGE TEMPERATURE RANGE: -40°C~+85°C;
  - OPERATION TEMPERATURE RANGE: -25°C~+70°C;
- SALT SPRAY TEST:24H(Excluding riveted bends)

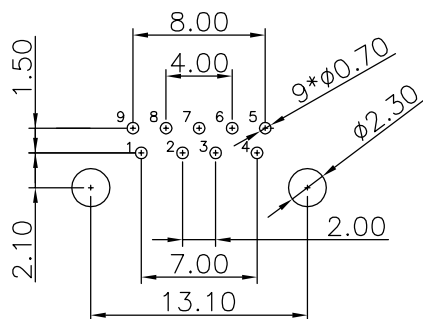
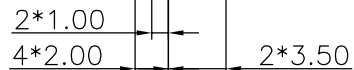
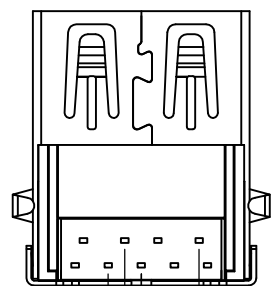
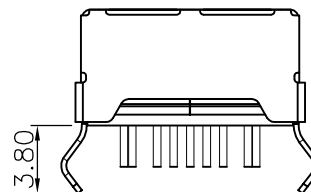
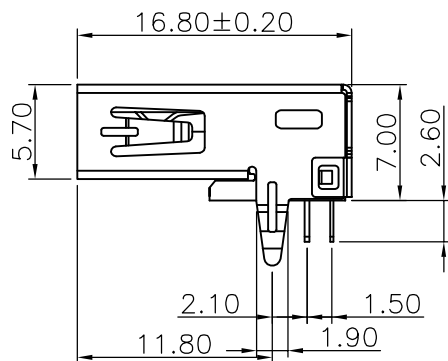
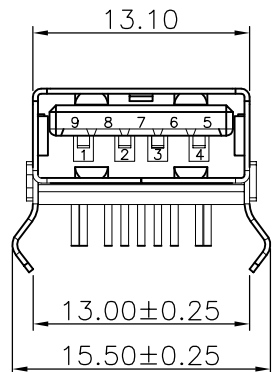
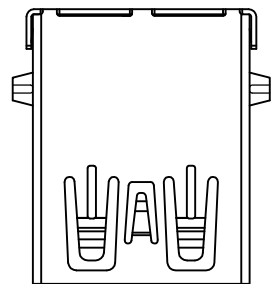

RECOMMENDER P. C. B. LAYOUT TOP VIEW  
(COMPONENT SIDE TOLERANCE±0.05)

C	外壳	SPCC	镀镍	
B	端子	黄铜H65	全周镀镍 焊料区镀锡 接触区镀金(1u)	
A	基座	PBT	蓝色	
序号	品名	材质	电镀/颜色	备注

# 深圳市虹成电子有限公司

UNLESS OTHERWISE, GENERAL TOLERANCE: X. xxx ±0.10 X. xx ±0.20 X. x ±0.30	NAME: 3.0 A母90° 弯脚平口	P/N: HC-USB3.0-L168-WP			
		DWG NO:			
ANGULAR: X. xx° ±1° X. x° ±3° X. ° ±5°	THIRD ANGLE PROJECTION 	UNIT: MM	SCALE: 1:1	SIZE: A4	SHEET: 1/1
	DRAWN:	CHECKED:		APPROVED:	

## X-ON Electronics

Largest Supplier of Electrical and Electronic Components

*Click to view similar products for [USB Connectors](#) category:*

*Click to view products by [Hong Cheng](#) manufacturer:*

Other Similar products are found below :

[950](#) [MUSBD11135](#) [17-200721](#) [217450-1](#) [KMBVX-TH-5S-B30](#) [KUSBX-AS2N-W](#) [KUSBX-SMT2AP1S-W30](#) [935](#) [957](#) [30-498-6](#) [SK-60A-2](#)  
[1734082-1](#) [30-470](#) [30-489](#) [30-541](#) [A-USB A-2P-C](#) [MIKROE-1451](#) [USBFTVSCCG](#) [1-1734084-2](#) [10135326-001LF](#) [4198](#) [USB-A-D-VT](#)  
[USB-A-S-RA-TSMT](#) [1310-1023-02](#) [690-024-633-031](#) [UB-20PMFP-LC7001](#) [17-200011](#) [UB-20AFMM-LL7A01](#) [1040870124](#) [CAP-](#)  
[WCCMLPB1](#) [CAP-WCCMLPC1](#) [2274475-3](#) [UB-20BMFA-SL8001](#) [914-614A2025S10200](#) [USB3FTV7SAGF059](#) [ZX40-B-5S-1500-](#)  
[STDA\(30\)](#) [GSB3116344HR](#) [USB3FTV2SAZNF459](#) [USB3FTV7SAZNF459](#) [U221-041N-1WVS62-F5D](#) [HYCW153-USBD05-500B](#)  
[HYCW219-USBD05-075B](#) [HYCW148-USBD05-117B](#) [HYCW149-USBD05-740B](#) [HYCW204-USBD05-108B](#) [HYCW214-USBA04-113B](#)  
[HYCW213-USBA04-113B](#) [UB-20AMFM-SL7A01](#) [KMMX-BSMT35S-1-B30TR](#) [2345986-1](#)