

RoHS 2.0

REV.	ECN NO.	DESCRIPTION	DATE	DESIGN
A1.	/.	新版发行	2022.12.02	LZR

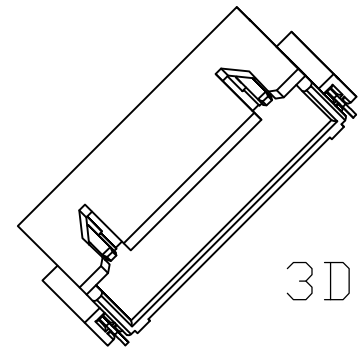

PIN	DIM A	DIM B	DIM C
2P	10.00	6.10	2.50
3P	12.50	8.60	5.00
4P	15.00	11.10	7.50
5P	17.50	13.60	10.00
6P	20.00	16.10	12.50

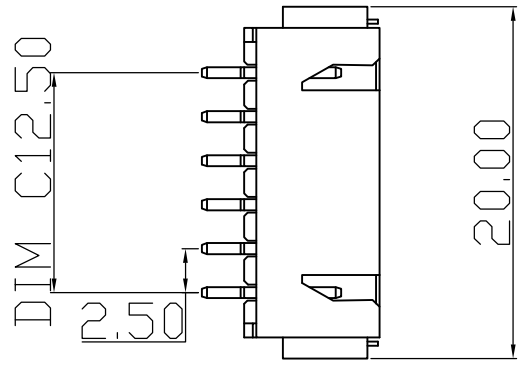
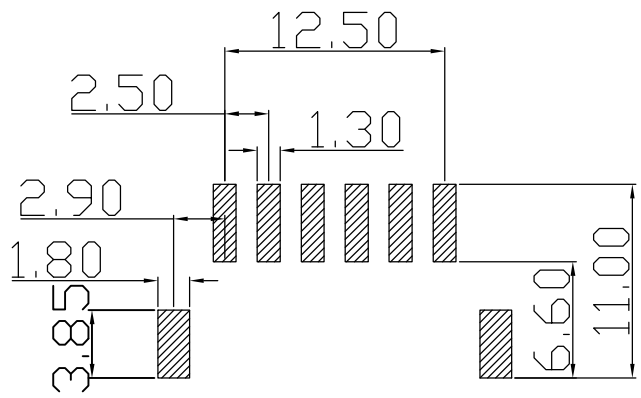
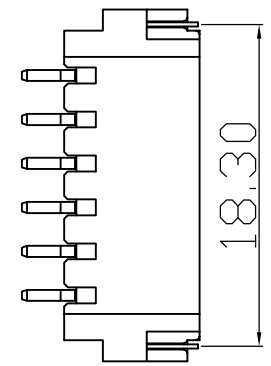
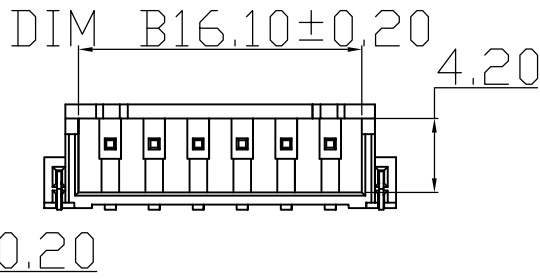
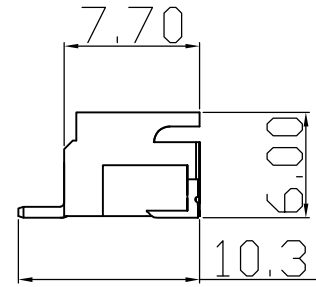
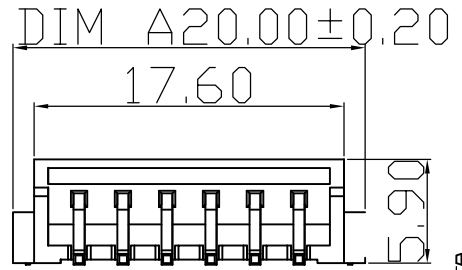

RECOMMENDER P.C.B.LAYOUT TOP VIEW
(COMPONENT SIDE TOLERANCE±0.1)

SPECIFICATION

- Contact resistance: $\leq 20\Omega$
- Insulation resistance: $\geq 10000\Omega$
- Rated voltage: 250 V AC DC
- Rated current: 3.0 A AC DC
- Withstand Voltage: 1000V AC/minute
- Temperature Range : $-25^{\circ}\text{C}\sim+85^{\circ}\text{C}$

C	插片	黄铜H65	镀镍锡	
B	插针	黄铜H65	镀镍锡	
A	基座	LCP	本色	
序号	品名	材质	电镀/颜色	备注

深圳市虹成电子有限公司

UNLESS OTHERWISE, GENERAL TOLERANCE: X.xxx ±0.10 X.xx ±0.20 X.x ±0.30	NAME: 2.5 针座卧贴		P/N: HCZZ0021-16			
			DWG NO:			
ANGULAR: X.xx° ±1° X.x° ±3° X° ±5°	THIRD ANGLE PROJECTION	UNIT: MM	SCALE: 1:1	SIZE: A4	SHEET: 1/1	REV. A1
	DRAWN:	CHECKED:		APPROVED:		

X-ON Electronics

Largest Supplier of Electrical and Electronic Components

Click to view similar products for [Headers & Wire Housings](#) category:

Click to view products by [Hong Cheng](#) manufacturer:

Other Similar products are found below :

[0015917161](#) [0022155065](#) [57102-F02-18ULF](#) [58102-G61-06LF](#) [582553-1](#) [01.001.5753.1](#) [0050291907](#) [02.125.8002.8](#) [609-3404](#) [61062-3](#)
[CSU011177004](#) [622-0430](#) [622-3653LF](#) [63453-116](#) [636-1030](#) [636-1427](#) [636-3427](#) [636-4007](#) [641938-9](#) [65495-038](#) [65692-001LF](#) [65781-018](#)
[65781-047](#) [65817-010LF](#) [65817-015LF](#) [67095-007LF](#) [67601157](#) [68631-112](#) [68645-018](#) [699319-000](#) [70.362.1628.0](#) [70-4210](#) [70-4226B](#) [70-](#)
[4853B](#) [71.350.2428.0](#) [733-134](#) [733-162](#) [760-3052](#) [MHR-64-VUAL](#) [80.063.4001.1](#) [800-90-001-10-001000](#) [801-43-002-10-013000](#)
[801-43-006-10-002000](#) [803-43-024-10-001000](#) [803-93-012-10-001000](#) [8-1437020-4](#) [819-22-004-30-001101](#) [820-22-006-30-001101](#)
[820-22-008-30-001101](#) [821-22-002-10-001101](#)