

RoHS 2.0

REV.	ECN NO.	DESCRIPTION	DATE	DESIGN
A0			23.04.11	LI

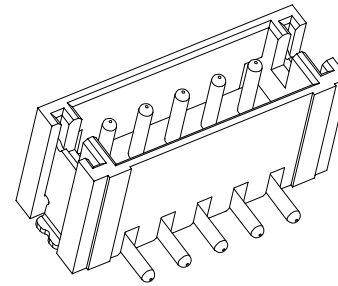

3D VIEW

PIN数	A±0.1	B±0.1	C±0.1
2P	6.00	3.60	1.50
3P	7.50	5.10	3.00
4P	9.00	6.60	4.50
5P	10.50	8.10	6.00
6P	12.00	9.60	7.50
7P	13.50	11.10	9.00
8P	15.00	12.60	10.50
9P	16.50	14.10	12.00
10P	18.00	15.60	13.50

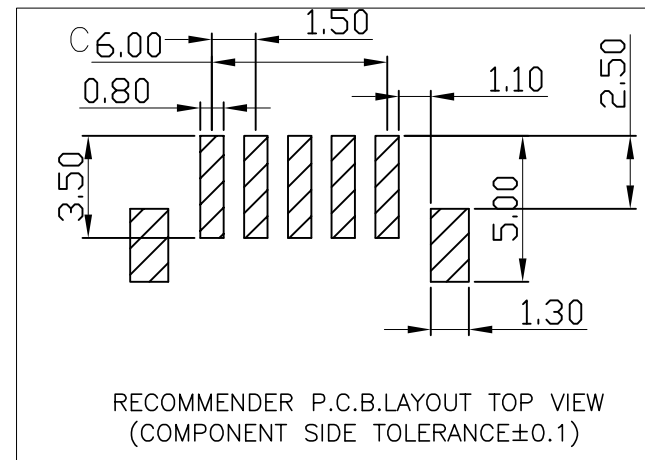
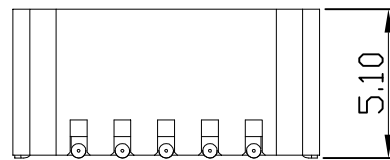
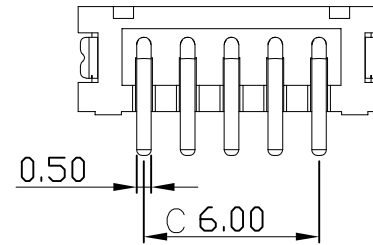
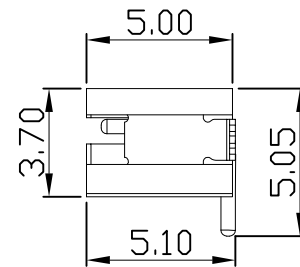
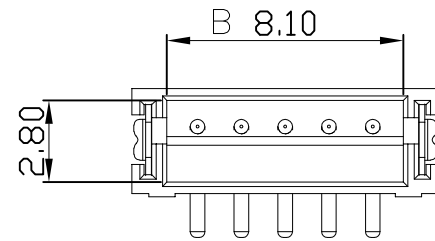
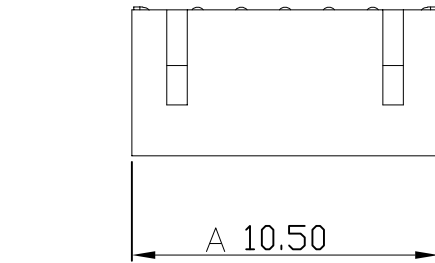

Specifications:

1. Rated Voltage : 100V AC/DC
2. Rated Current : 1A AC,DC
3. Withstand Voltage : 500V AC/minute
4. Contact Resistance : 50mΩ(MAX.)
5. Insulation Resistance : 500MΩ(MIN.)
6. Storage Temperature Range: -40°C~+85°C;
7. Operation Temperature Range: -25°C~+70°C;

C	插片	黄铜	镀镍锡	
B	插针	黄铜	镀镍锡	
A	底座	LCP	本色	
序号	品名	材质	电镀/颜色	备注

深圳市虹成电子有限公司

UNLESS OTHERWISE, GENERAL TOLERANCE: X. xxx ±0.10 X. xx ±0.20 X. x ±0.30	NAME: <b>1.5 立贴13PIN针座</b>	P/N: HCZZ0068-13
	DWG NO:	
THIRD ANGLE PROJECTION 	UNIT: MM	SCALE: 1:1
SIZE: A4	SHBET: 1/1	REV. A1
DRAWN:	CHECKED:	APPROVED:

## X-ON Electronics

Largest Supplier of Electrical and Electronic Components

*Click to view similar products for [Headers & Wire Housings](#) category:*

*Click to view products by [Hong Cheng](#) manufacturer:*

Other Similar products are found below :

[0015917161](#) [0022155065](#) [57102-F02-18ULF](#) [58102-G61-06LF](#) [582553-1](#) [01.001.5753.1](#) [0050291907](#) [02.125.8002.8](#) [609-3404](#) [61062-3](#)  
[CSU011177004](#) [622-0430](#) [622-3653LF](#) [63453-116](#) [636-1030](#) [636-1427](#) [636-3427](#) [636-4007](#) [641938-9](#) [65495-038](#) [65692-001LF](#) [65781-018](#)  
[65781-047](#) [65817-010LF](#) [65817-015LF](#) [67095-007LF](#) [67601157](#) [68631-112](#) [68645-018](#) [699319-000](#) [70.362.1628.0](#) [70-4210](#) [70-4226B](#) [70-](#)  
[4853B](#) [71.350.2428.0](#) [733-134](#) [733-162](#) [760-3052](#) [MHR-64-VUAL](#) [80.063.4001.1](#) [800-90-001-10-001000](#) [801-43-002-10-013000](#)  
[801-43-006-10-002000](#) [803-43-024-10-001000](#) [803-93-012-10-001000](#) [8-1437020-4](#) [819-22-004-30-001101](#) [820-22-006-30-001101](#)  
[820-22-008-30-001101](#) [821-22-002-10-001101](#)