

| 版次 (Ed) | 变更摘要 (Change The Content) | 日期 (Date) | 序号 (NO.) | 品名 (Name) | 材质 (Material) |
|---------|----------------------------|------------|----------|-----------|---------------|
| 0 | 新产品发行 (New Product Launch) | 2017/09/06 | | | |

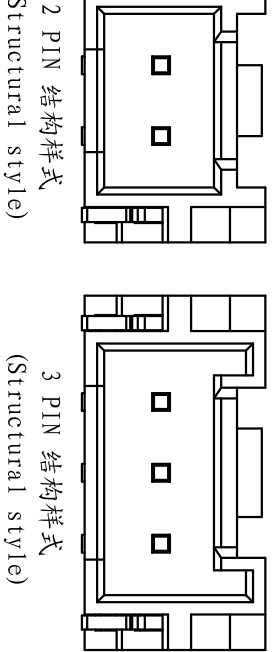
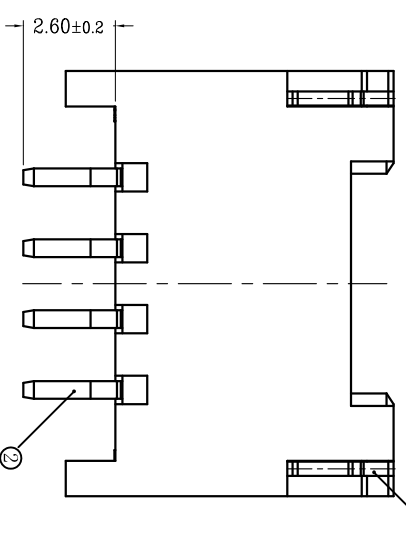
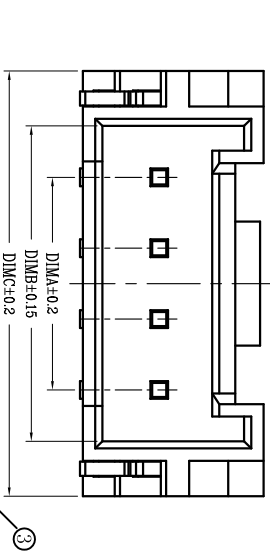
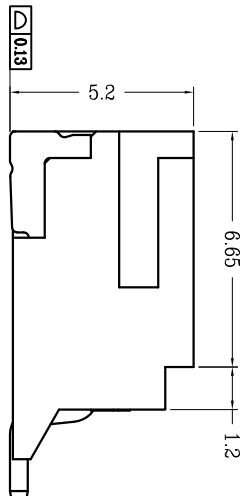
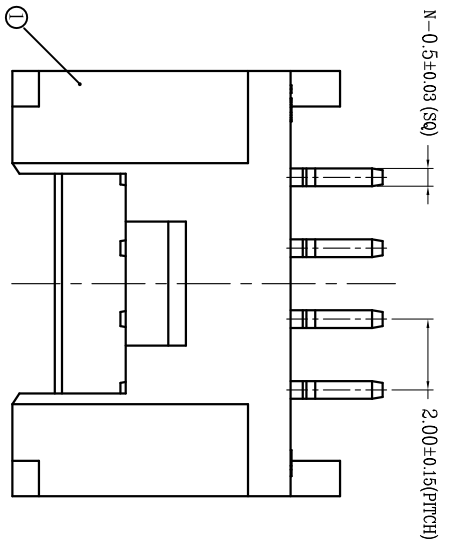
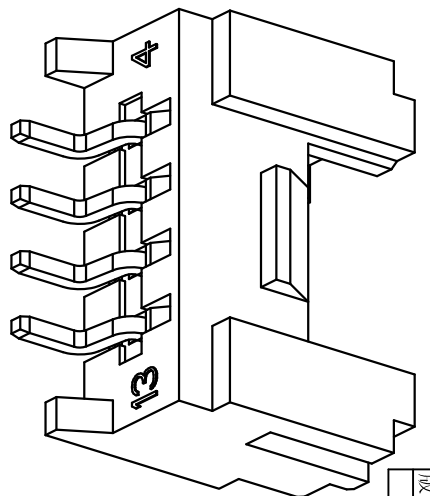

技术指标 (Technical Index):

1. 塑件表面应光洁、无毛边、无明显收缩、缺陷、裂纹等现象。
(The surface of the plastic parts should be smooth, no rough edges, no obvious shrinkage, defects, cracks and other phenomena)
2. 温度范围 (Temperature range): -40° C~+85° C.
3. 额定电压 (Rated voltage): 200V, AC.
4. 接触电阻 (Contact resistance): ≤55mΩ (Initial) per contact, ≤25mΩ Change allowed.
5. 绝缘电阻 (Insulation resistance): ≥1000MΩ.
6. 产品料号 (Product material No.): WT200FW—** *—2*

NO OF CKT (产品PIN数)

Plating (电镀方式)

- 1: 端子全金 (Terminal G/F OVER ALL)
- 4: 端子全亮锡 (Terminal all bright tin)

| | |
|----|----------------------------------|
| 20 | 底座有LOGO,WD(fousing with LOGO,WD) |
| 2W | 底座无LOGO(fousing without LOGO) |

Packing (包装方式)

- T: TUBE管装
- R: TAPE & REEL卷装

适用线路板 (PCB LAYOUT)

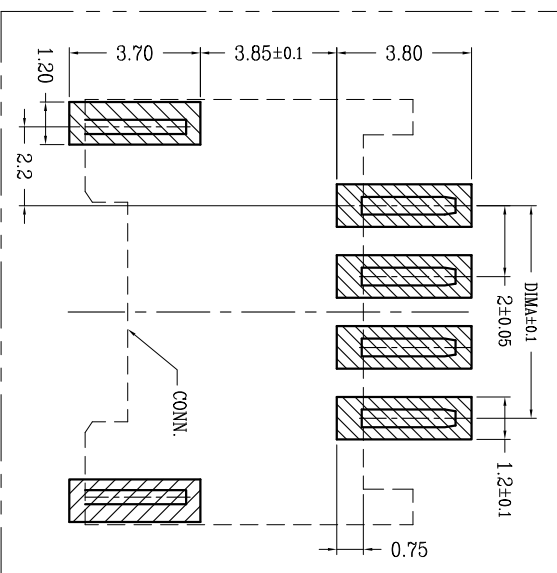

| CKT | DIM A | DIM B | DIM C |
|-----|-------|-------|-------|
| 2 | 2.00 | 4.90 | 8.00 |
| 3 | 4.00 | 6.90 | 10.00 |
| 4 | 6.00 | 8.90 | 12.00 |
| 5 | 8.00 | 10.90 | 14.00 |
| 6 | 10.00 | 12.90 | 16.00 |
| 7 | 12.00 | 14.90 | 18.00 |
| 8 | 14.00 | 16.90 | 20.00 |
| 9 | 16.00 | 18.90 | 22.00 |
| 10 | 18.00 | 20.90 | 24.00 |
| 11 | 20.00 | 22.90 | 26.00 |
| 12 | 22.00 | 24.90 | 28.00 |
| 13 | 24.00 | 26.90 | 30.00 |
| 14 | 26.00 | 28.90 | 32.00 |
| 15 | 28.00 | 30.90 | 34.00 |
| 16 | 30.00 | 32.90 | 36.00 |
| 17 | 32.00 | 34.90 | 38.00 |
| 18 | 34.00 | 36.90 | 40.00 |
| 19 | 36.00 | 38.90 | 42.00 |
| 20 | 38.00 | 40.90 | 44.00 |

深圳市虹成电子有限公司



一般公差 (TOLERANCE)
X ±.50 XX ±.10
X ±.20 XXX ±.05
ANGLES ±1°

| | | | |
|------------|----------------------|------------|--------|
| 品名 (TITLE) | 2.00 Pitch F型卧式2代WTB | 制图 (DR) | Anlan |
| 料号 (DWGNO) | HCZZ0383-14 | 审核 (APPD) | 黄志明 |
| 比例 (SCALE) | 1:1 | 校对 (CHKD) | 王涛 |
| 单位 (UNITS) | mm | 张数 (SHEET) | 1 Of 1 |
| 尺寸 (SIZE) | A4 | 版本 (REV) | A |

X-ON Electronics

Largest Supplier of Electrical and Electronic Components

Click to view similar products for [Headers & Wire Housings](#) category:

Click to view products by [Hong Cheng](#) manufacturer:

Other Similar products are found below :

[0015917161](#) [0022155065](#) [57102-F02-18ULF](#) [58102-G61-06LF](#) [582553-1](#) [01.001.5753.1](#) [0050291907](#) [02.125.8002.8](#) [609-3404](#) [61062-3](#)
[CSU011177004](#) [622-0430](#) [622-3653LF](#) [63453-116](#) [636-1030](#) [636-1427](#) [636-3427](#) [636-4007](#) [641938-9](#) [65495-038](#) [65692-001LF](#) [65781-018](#)
[65781-047](#) [65817-010LF](#) [65817-015LF](#) [67095-007LF](#) [67601157](#) [68631-112](#) [68645-018](#) [699319-000](#) [70.362.1628.0](#) [70-4210](#) [70-4226B](#) [70-](#)
[4853B](#) [71.350.2428.0](#) [733-134](#) [733-162](#) [760-3052](#) [MHR-64-VUAL](#) [80.063.4001.1](#) [800-90-001-10-001000](#) [801-43-002-10-013000](#)
[801-43-006-10-002000](#) [803-43-024-10-001000](#) [803-93-012-10-001000](#) [8-1437020-4](#) [819-22-004-30-001101](#) [820-22-006-30-001101](#)
[820-22-008-30-001101](#) [821-22-002-10-001101](#)