

版次 (Ed)	变更摘要 (Change The Content)	日期 (Date)	序号 (NO.)	品名 (Name)	材质 (Material)
0	新产品发行 (New Product Launch)	2017/09/06	①	2.00 F型端子2代(WTB)胶芯 2.00 Pitch R/A Wire To Board Housing (H=5.2)	LCP 本色 Natural

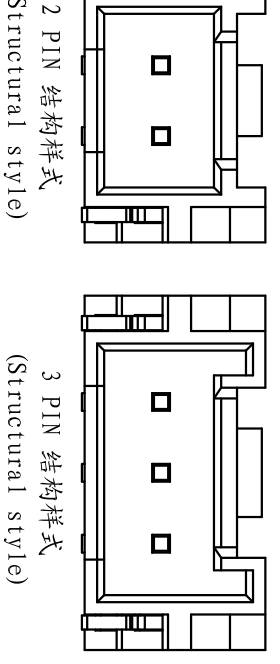
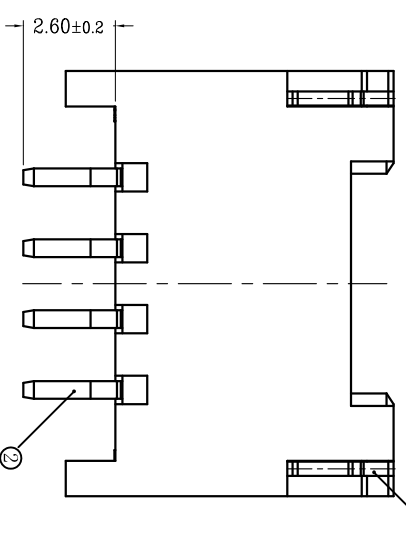
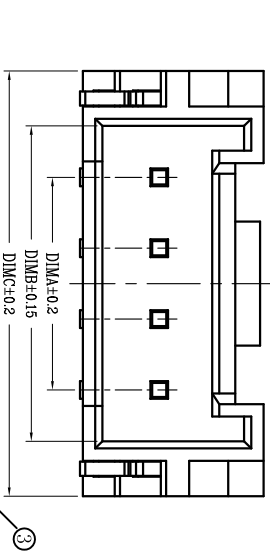
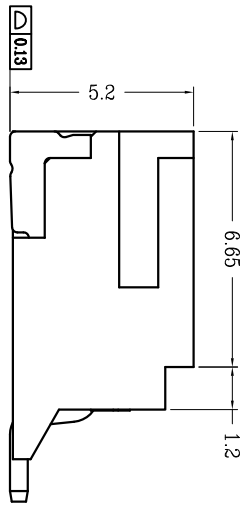
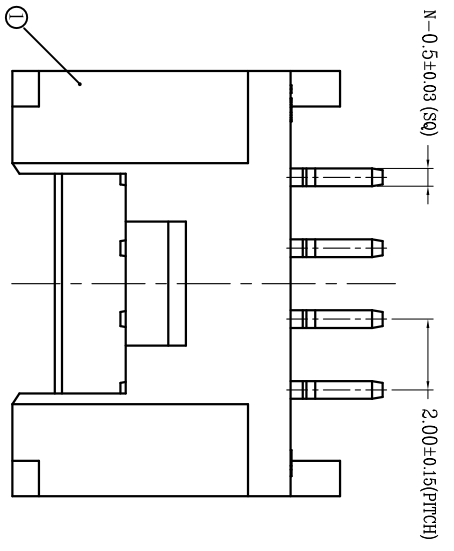
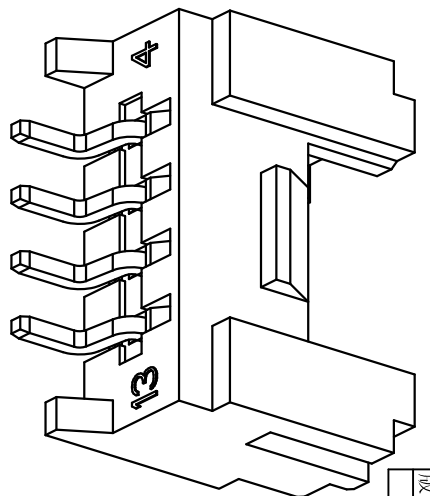

技术指标 (Technical Index):

1. 塑件表面应光洁、无毛边、无明显收缩、缺陷、裂纹等现象。
(The surface of the plastic parts should be smooth, no rough edges, no obvious shrinkage, defects, cracks and other phenomena)
2. 温度范围 (Temperature range): -40° C~+85° C.
3. 额定电压 (Rated voltage): 200V, AC.
4. 接触电阻 (Contact resistance): ≤55mΩ (Initial) per contact, ≤25mΩ Change allowed.
5. 绝缘电阻 (Insulation resistance): ≥1000MΩ.
6. 产品料号 (Product material No.): WT200FW—** * *—2*

NO OF CKT (产品PIN数)

Plating (电镀方式)

- 1: 端子全金 (Terminal G/F OVER ALL)
- 4: 端子全亮锡 (Terminal all bright tin)

20	胶芯有LOGO(WD)housing with LOGO(WD)
2W	胶芯无LOGO(housing without LOGO)

Packing (包装方式)

- T: TUBE管装
- R: TAPE & REEL卷装

适用线路板 (PCB LAYOUT)

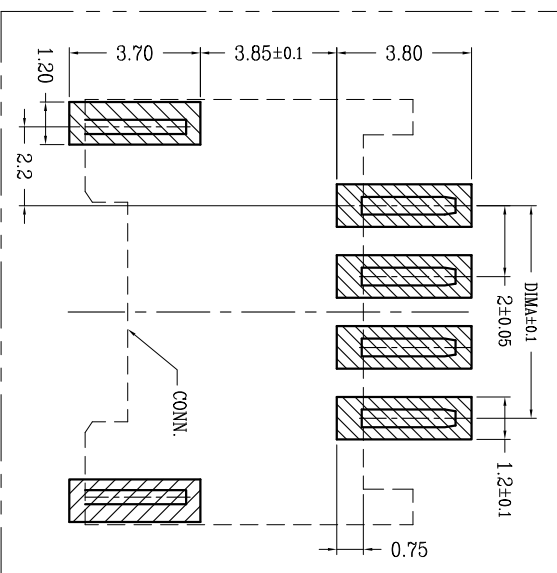

CKT	DIM A	DIM B	DIM C
2	2.00	4.90	8.00
3	4.00	6.90	10.00
4	6.00	8.90	12.00
5	8.00	10.90	14.00
6	10.00	12.90	16.00
7	12.00	14.90	18.00
8	14.00	16.90	20.00
9	16.00	18.90	22.00
10	18.00	20.90	24.00
11	20.00	22.90	26.00
12	22.00	24.90	28.00
13	24.00	26.90	30.00
14	26.00	28.90	32.00
15	28.00	30.90	34.00
16	30.00	32.90	36.00
17	32.00	34.90	38.00
18	34.00	36.90	40.00
19	36.00	38.90	42.00
20	38.00	40.90	44.00

深圳市虹成电子有限公司



一般公差 (TOLERANCE)
X ±.50 XX ±.10
X ±.20 XXX ±.05
ANGLES ±1°

品名 (TITLE)	2.00 Pitch F型卧式2代WTB	制图 (DR)	Anlan
料号 (DWGNO)	HCZZ0383-7	审核 (APPD)	黄志明
比例 (SCALE)	1:1	校对 (CHKD)	王涛
单位 (UNITS)	mm	张数 (SHEET)	1 Of 1
尺寸 (SIZE)	A4	版本 (REV)	A

X-ON Electronics

Largest Supplier of Electrical and Electronic Components

Click to view similar products for [Headers & Wire Housings](#) category:

Click to view products by [Hong Cheng](#) manufacturer:

Other Similar products are found below :

[0015917161](#) [0022155065](#) [57102-F02-18ULF](#) [58102-G61-06LF](#) [582553-1](#) [01.001.5753.1](#) [0050291907](#) [02.125.8002.8](#) [609-3404](#) [61062-3](#)
[CSU011177004](#) [622-0430](#) [622-3653LF](#) [63453-116](#) [636-1030](#) [636-1427](#) [636-3427](#) [636-4007](#) [641938-9](#) [65495-038](#) [65692-001LF](#) [65781-018](#)
[65781-047](#) [65817-010LF](#) [65817-015LF](#) [67095-007LF](#) [67601157](#) [68631-112](#) [68645-018](#) [699319-000](#) [70.362.1628.0](#) [70-4210](#) [70-4226B](#) [70-](#)
[4853B](#) [71.350.2428.0](#) [733-134](#) [733-162](#) [760-3052](#) [MHR-64-VUAL](#) [80.063.4001.1](#) [800-90-001-10-001000](#) [801-43-002-10-013000](#)
[801-43-006-10-002000](#) [803-43-024-10-001000](#) [803-93-012-10-001000](#) [8-1437020-4](#) [819-22-004-30-001101](#) [820-22-006-30-001101](#)
[820-22-008-30-001101](#) [821-22-002-10-001101](#)