

RoHS 2.0

REV.	ECN NO.	DESCRIPTION	DATE	DESIGN
A0.	/.	新版发行	2021.11.27	Willming

PIN	DIM A	DIM B	DIM C
2P	8.00	4.80	2.00
3P	10.00	6.80	4.00
4P	12.00	8.80	6.00
5P	14.00	10.80	8.00
6P	16.00	12.80	10.00

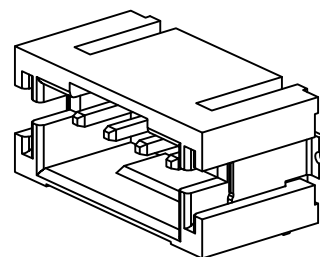

3D View

Specifications:

1. Rated Voltage : 250V AC/DC
2. Rated Current : 5A AC,DC
3. Withstand Voltage : 200V AC/minute
4. Contact Resistance : 50mΩ(MAX.)
5. Insulation Resistance : 1000MΩ(MIN.)
6. Storage Temperature Range: -40°C~+85°C;
7. Operation Temperature Range: -25°C~+70°C;

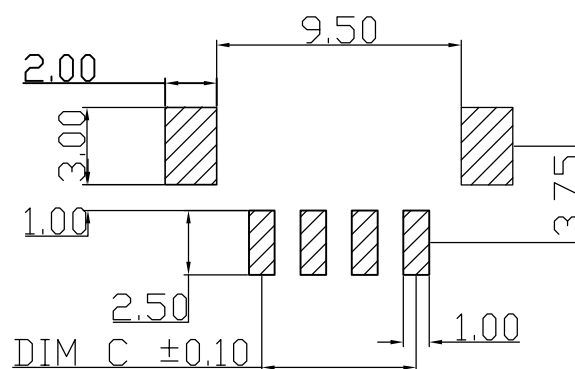
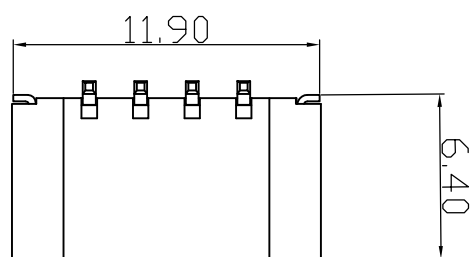
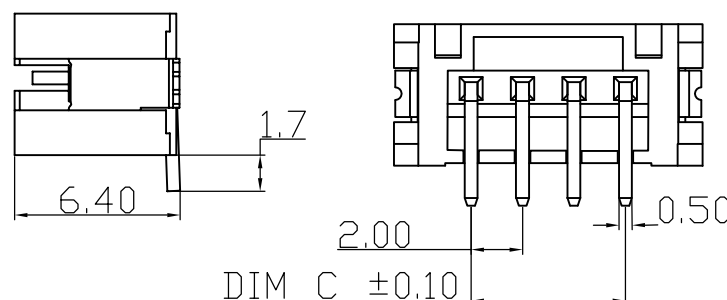
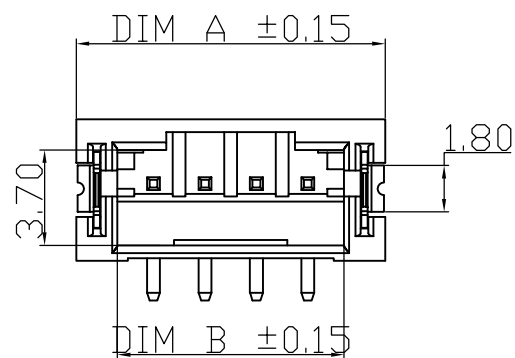
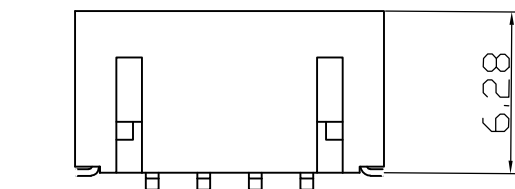

RECOMMENDER P.C.B.LAYOUT TOP VIEW

3	插片	黄铜H65	镀镍锡	
2	插针	黄铜H65	镀镍锡	
1	底座	LCP	本色	
序号	品名	材质	电镀/颜色	备注

深圳虹成电子有限公司

UNLESS OTHERWISE, GENERAL TOLERANCE: X. xxx ±0.05 X. xx ±0.15 X. x ±0.25	NAME: 针座2.0立贴	P/N: HCZZ0469-7			
	DWG NO:				
THIRD ANGLE PROJECTION 	UNIT:	SCALE:	SIZE:	SHEET:	REV.
	MM	1:1	A4	1/1	A1
ANGULAR: X. xx° ±1° X. x° ±3° X. ° ±5°	DRAWN:		CHECKED:		APPROVED:

X-ON Electronics

Largest Supplier of Electrical and Electronic Components

Click to view similar products for [Headers & Wire Housings](#) category:

Click to view products by [Hong Cheng](#) manufacturer:

Other Similar products are found below :

[0015917161](#) [0022155065](#) [57102-F02-18ULF](#) [58102-G61-06LF](#) [582553-1](#) [01.001.5753.1](#) [0050291907](#) [02.125.8002.8](#) [609-3404](#) [61062-3](#)
[CSU011177004](#) [622-0430](#) [622-3653LF](#) [63453-116](#) [636-1030](#) [636-1427](#) [636-3427](#) [636-4007](#) [641938-9](#) [65495-038](#) [65692-001LF](#) [65781-018](#)
[65781-047](#) [65817-010LF](#) [65817-015LF](#) [67095-007LF](#) [67601157](#) [68631-112](#) [68645-018](#) [699319-000](#) [70.362.1628.0](#) [70-4210](#) [70-4226B](#) [70-](#)
[4853B](#) [71.350.2428.0](#) [733-134](#) [733-162](#) [760-3052](#) [MHR-64-VUAL](#) [80.063.4001.1](#) [800-90-001-10-001000](#) [801-43-002-10-013000](#)
[801-43-006-10-002000](#) [803-43-024-10-001000](#) [803-93-012-10-001000](#) [8-1437020-4](#) [819-22-004-30-001101](#) [820-22-006-30-001101](#)
[820-22-008-30-001101](#) [821-22-002-10-001101](#)