

REV.	EC#	DESCRIPTION	DATE	DRAWN	CHECK	APPROVED
1.00		初版发行	2018-04-22			

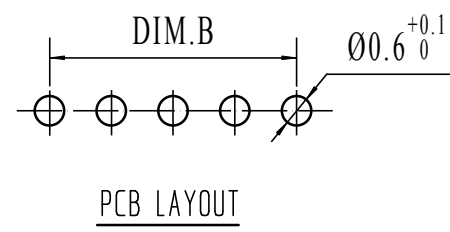
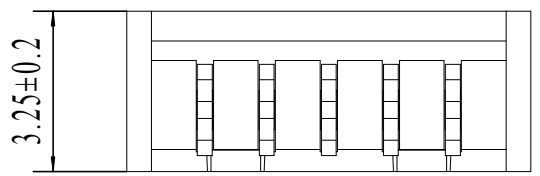
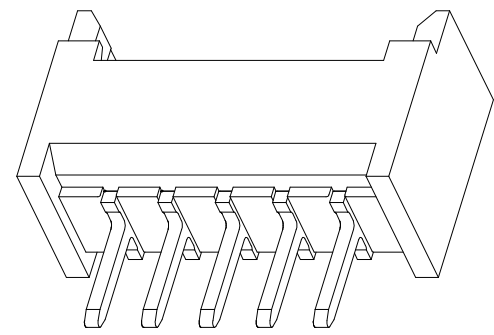
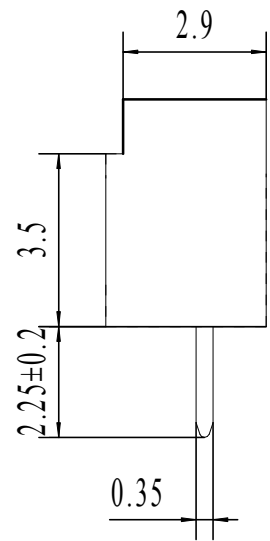
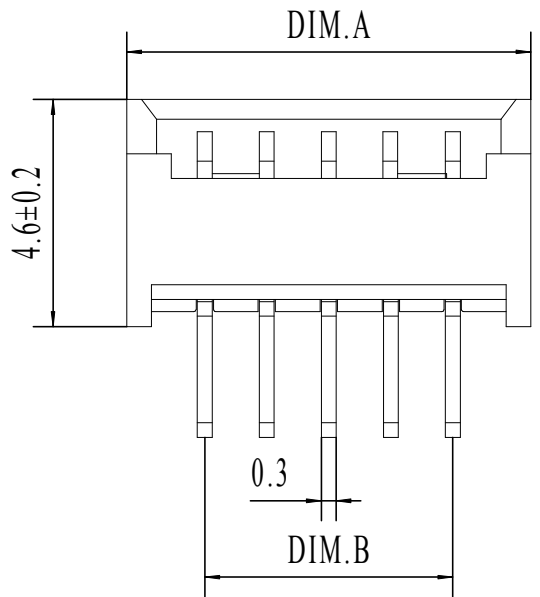

15	20.65	17.50
14	19.4	16.25
13	18.15	15.00
12	16.9	13.75
11	15.65	12.50
10	14.4	11.25
9	13.15	10.00
8	11.9	8.75
7	10.65	7.50
6	9.4	6.25
5	8.15	5.00
4	6.9	3.75
3	5.65	2.50
2	4.4	1.25
Pin	DIM.A	DIM.B

适应基板厚度: 1.2mm~1.6mm
 温度范围: -25°C~85°C
 额定电压: 125V AC/DC
 额定电流: 1A
 接触电阻: ≤0.02Ω
 绝缘电阻: ≥100MΩ
 耐压: 500V AC/minute

技术要求:

- 1) 材质: 见附表;
- 2) 电镀: 见附表;
- 3) 塑件表面平整、光洁、无毛刺、气泡、烧焦、变形、浇口无拉伤、多料或缺料等不良现象;
- 4) 端子表面无氧化、电镀不良等现象。

GENERAL TOLERANCES			
DIM	TOL	DIM	DEG
X		X°	±3.00°
X.X	±0.35	X.X°	±2.00°
X.XX	±0.25	X.XX°	±1.00°
X.XXX	±0.15	X.XXX°	

2	PIN	n PCS	材质: 黄铜, 电镀: 镀亮锡60u"MIN
1	Housing	1 PCS	材质: PA6T 颜色: 本色或黑色
NO.	NAME	QTY	DESCRIPTION

深圳市虹成电子有限公司

DRAW:	2018-04-22	TITLE:	1.25LDIP CONN WAFER	DRAW NAME:	HCZZ0566-14
DESIGN:	2018-04-22	SERIES:	12502 SERIES	DRAW NO.	
CHECK:	2018-04-22	P/N:		UNIT:	SHEET:
APPROVED	2018-04-22	CUSTOMER DRAWING	REV. 1.00	SCALE	N/A
		mm	1/1		

X-ON Electronics

Largest Supplier of Electrical and Electronic Components

Click to view similar products for [Headers & Wire Housings](#) category:

Click to view products by [Hong Cheng](#) manufacturer:

Other Similar products are found below :

[0015917161](#) [0022155065](#) [57102-F02-18ULF](#) [58102-G61-06LF](#) [582553-1](#) [01.001.5753.1](#) [0050291907](#) [02.125.8002.8](#) [609-3404](#) [61062-3](#)
[CSU011177004](#) [622-0430](#) [622-3653LF](#) [63453-116](#) [636-1030](#) [636-1427](#) [636-3427](#) [636-4007](#) [641938-9](#) [65495-038](#) [65692-001LF](#) [65781-018](#)
[65781-047](#) [65817-010LF](#) [65817-015LF](#) [67095-007LF](#) [67601157](#) [68631-112](#) [68645-018](#) [699319-000](#) [70.362.1628.0](#) [70-4210](#) [70-4226B](#) [70-](#)
[4853B](#) [71.350.2428.0](#) [733-134](#) [733-162](#) [760-3052](#) [MHR-64-VUAL](#) [80.063.4001.1](#) [800-90-001-10-001000](#) [801-43-002-10-013000](#)
[801-43-006-10-002000](#) [803-43-024-10-001000](#) [803-93-012-10-001000](#) [8-1437020-4](#) [819-22-004-30-001101](#) [820-22-006-30-001101](#)
[820-22-008-30-001101](#) [821-22-002-10-001101](#)