

版本	变更摘要	日期
0	新产品发行	2021/06/03

序号	品名	材质
①	WH3_96立式WTB胶芯	LCP 本色
②	WH3_96立式WTB端子	铜合金/表面镀锡
③	WH3_96立式WTB焊片	铜合金/表面镀锡
④	WH3_96立式WTB吸盖	LCP 本色/黑色

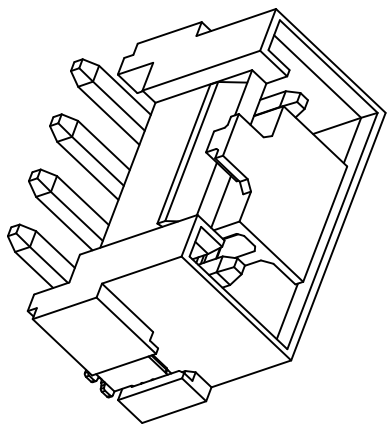

技术指标:

1. 塑件表面应光洁、无毛边、无明显收缩、缺陷、裂纹等现象
2. 温度范围: -25°C~85°C
3. 额定电压: 250V, AC DC.
4. 额定电流: 7.0 A, AC DC.
5. 接触电阻: $\leq 30m\Omega$ Min
5. 绝缘电阻: $\geq 1000M\Omega$.
6. 耐压值: 1500V AC/minute
6. 产品料号: WT396VL

NO OF CKT (产品PIN数)

Plating (电镀方式)

0: 端子全雾锡

1: 端子全金 (G/F OVERALL)

4: 端子全亮锡

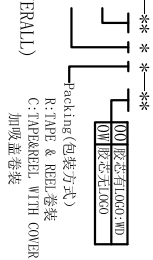

Packing (包装方式)

R: TAPE & REEL 卷盘

C: TAPERBAG, WITH COVER 加放防静电袋

CKT	A	B	C	D	E
2	3.96	8.68	10.18	11.84	3.88
3	7.92	12.64	14.14	15.80	7.84
4	11.88	16.60	18.10	19.76	
5	15.84	20.56	22.06	23.72	
6	19.80	24.52	26.02	27.68	
7	23.76	28.48	29.98	31.64	
8	27.72	32.44	33.94	35.60	
9	31.68	36.40	37.90	39.56	
10	35.64	40.36	41.86	43.52	10.00
11	39.60	44.32	45.82	47.48	
12	43.56	48.28	49.78	51.44	
13	47.52	52.24	53.74	55.40	
14	51.48	56.20	57.70	59.36	
15	55.44	60.16	61.66	63.32	
16	59.40	64.12	65.62	67.28	

适用线路板 (厚度: 0.8mm~1.6mm)

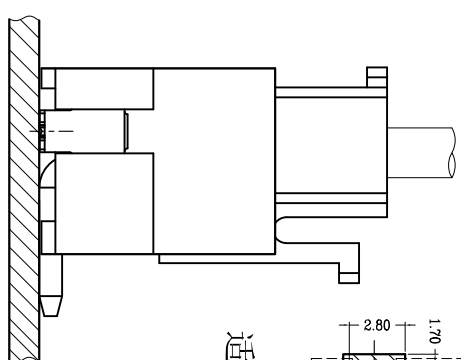
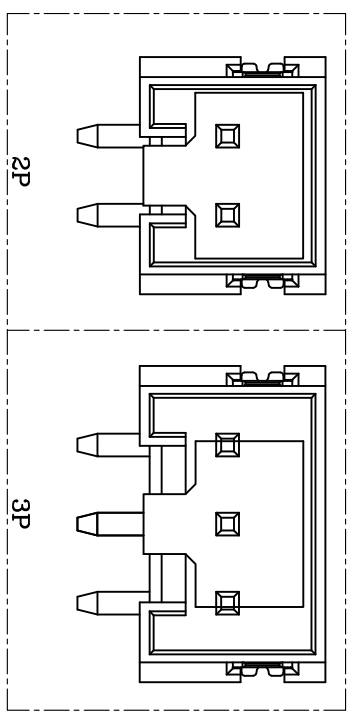
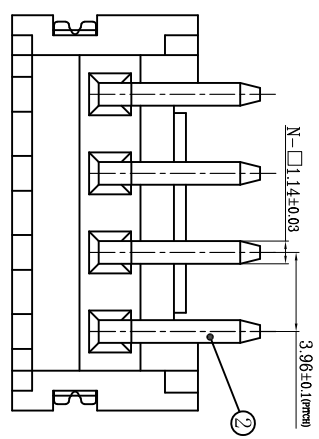
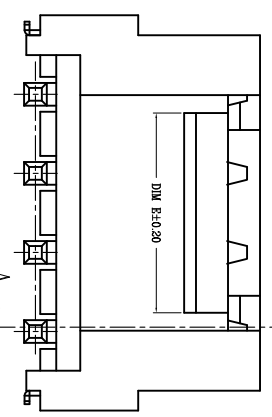
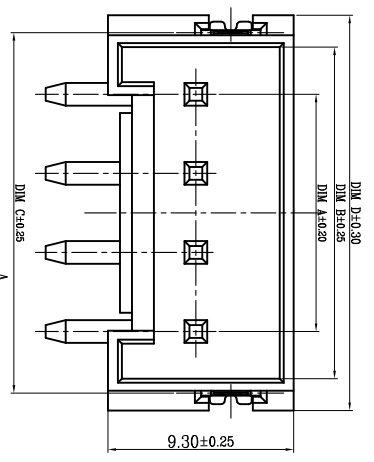
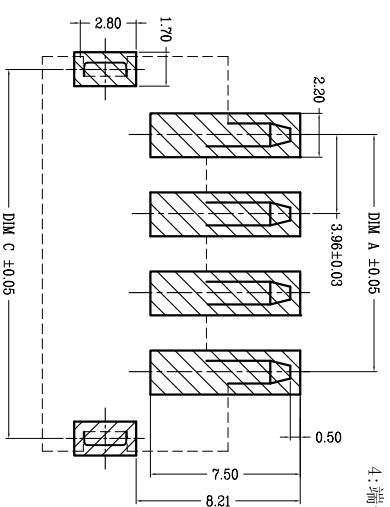

Assembly Layout



一般公差 (TOLERANCE)
X: ±.50 XX: ±.10
Y: ±.20 XXX: ±.05
ANGLES ±1°

深圳市虹成电子有限公司

品名 (TITLE) WH3_96立式WTB业务图

料号 (DWG.NO) HCZZ0596-8

比例 (SCALE) 1:1

制图 (DR) ANLAN

校对 (CHKD) 李绍宗

审核 (APPD) 黄志明

张数 (SHEET) 1 Of 1

尺寸 (SIZE) A4

版本 (REV) A

X-ON Electronics

Largest Supplier of Electrical and Electronic Components

Click to view similar products for [Headers & Wire Housings](#) category:

Click to view products by [Hong Cheng](#) manufacturer:

Other Similar products are found below :

[0015917161](#) [0022155065](#) [57102-F02-18ULF](#) [58102-G61-06LF](#) [582553-1](#) [01.001.5753.1](#) [0050291907](#) [02.125.8002.8](#) [609-3404](#) [61062-3](#)
[CSU011177004](#) [622-0430](#) [622-3653LF](#) [63453-116](#) [636-1030](#) [636-1427](#) [636-3427](#) [636-4007](#) [641938-9](#) [65495-038](#) [65692-001LF](#) [65781-018](#)
[65781-047](#) [65817-010LF](#) [65817-015LF](#) [67095-007LF](#) [67601157](#) [68631-112](#) [68645-018](#) [699319-000](#) [70.362.1628.0](#) [70-4210](#) [70-4226B](#) [70-](#)
[4853B](#) [71.350.2428.0](#) [733-134](#) [733-162](#) [760-3052](#) [MHR-64-VUAL](#) [80.063.4001.1](#) [800-90-001-10-001000](#) [801-43-002-10-013000](#)
[801-43-006-10-002000](#) [803-43-024-10-001000](#) [803-93-012-10-001000](#) [8-1437020-4](#) [819-22-004-30-001101](#) [820-22-006-30-001101](#)
[820-22-008-30-001101](#) [821-22-002-10-001101](#)