

REV.	EC#	DESCRIPTION	DATE	DRAWN	CHECK	APPROVED
1.00		初版发行	2018-05-28	瞿寿坤	胡海萍	胡海萍

NUMBER OF PINS	DIM.A	DIM.B
9P	31.68	35.64
8P	27.72	31.68
7P	23.76	27.72
6P	19.8	23.76
5P	15.84	19.8
4P	11.88	15.84
3P	7.92	11.88
2P	3.96	7.92

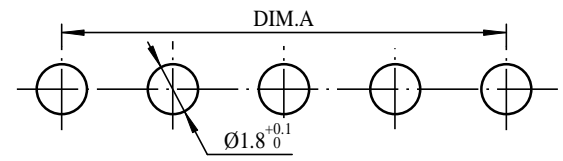
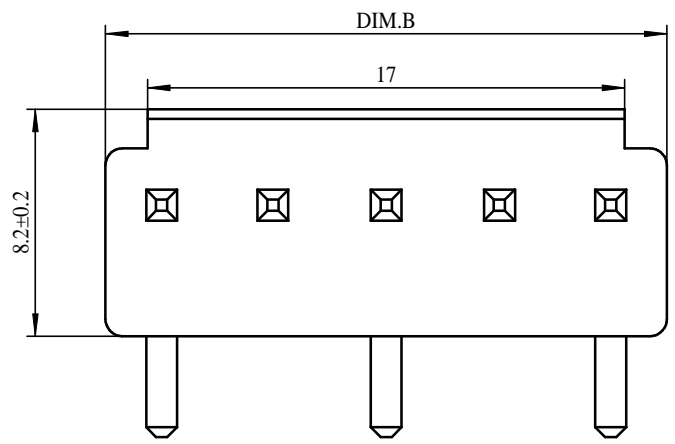
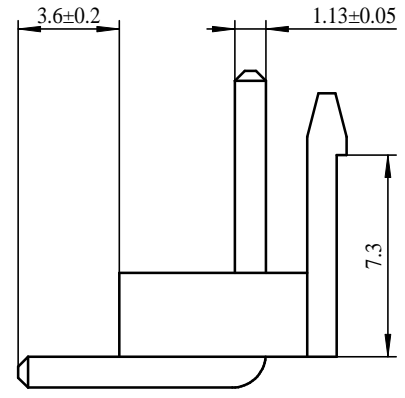
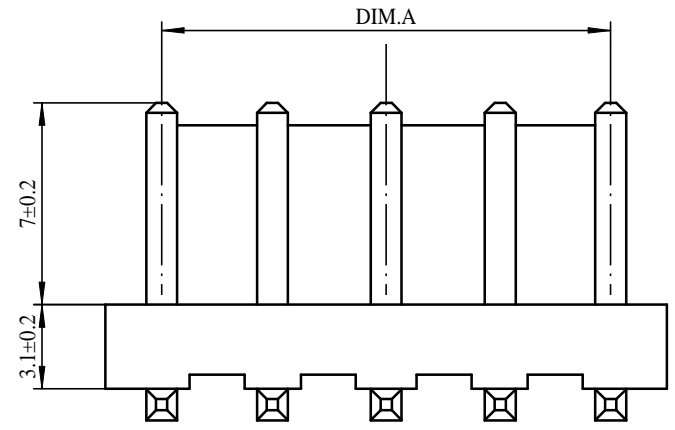

PCB LAYOUT

GENERAL TOLERANCES			
DIM	TOL	DIM	DEG
X.		X°	±3.00°
X.X	±0.35	X.X°	±2.00°
X.XX	±0.25	X.XX°	±1.00°
X.XXX	±0.15	X.XXX°	

技术要求:

- 1) 材质:见附表;
- 2) 电镀:见附表;
- 3) 塑件表面平整、光洁、无毛刺、气泡、烧焦、变形、浇口无拉伤、多料或缺料等不良现象;
- 4) 端子表面无氧化、电镀不良等现象。

适应基板厚度: 1.2mm~1.6mm
 温度范围: -25℃~85℃
 额定电压: 250V AC/DC
 额定电流: 7A
 接触电阻: $\leq 0.01 \Omega$
 绝缘电阻: >math>\geq 1000M \Omega</math>
 耐压: 1500V AC/minute

NO.	NAME	Q'TY	DESCRIPTION
2	PIN	n PCS	材质:黄铜,电镀:镀亮锡60u"MIN
1	Housing	1 PCS	材质:PA66 颜色:本色

深圳虹成电子有限公司

DRAW :	瞿寿坤	2018-04-22	TITLE:	WAFER 3.96VHWA 卧式 DIP	DRAW NAME:	HCZZ0604-5	
DESIGN:	瞿寿坤	2018-04-22	SERIES:	1501 SERIES	DRAW NO.		
CHECK:	胡海萍	2018-04-22	P/N:		UNIT:	SHEET:	+ □
APPROVED	胡海萍	2018-04-22	CUSTOMER DRAWING	REV. 1.00	SCALE	N/A	

X-ON Electronics

Largest Supplier of Electrical and Electronic Components

Click to view similar products for [Headers & Wire Housings](#) category:

Click to view products by [Hong Cheng](#) manufacturer:

Other Similar products are found below :

[0015917161](#) [0022155065](#) [57102-F02-18ULF](#) [58102-G61-06LF](#) [582553-1](#) [01.001.5753.1](#) [0050291907](#) [02.125.8002.8](#) [609-3404](#) [61062-3](#)
[CSU011177004](#) [622-0430](#) [622-3653LF](#) [63453-116](#) [636-1030](#) [636-1427](#) [636-3427](#) [636-4007](#) [641938-9](#) [65495-038](#) [65692-001LF](#) [65781-018](#)
[65781-047](#) [65817-010LF](#) [65817-015LF](#) [67095-007LF](#) [67601157](#) [68631-112](#) [68645-018](#) [699319-000](#) [70.362.1628.0](#) [70-4210](#) [70-4226B](#) [70-](#)
[4853B](#) [71.350.2428.0](#) [733-134](#) [733-162](#) [760-3052](#) [MHR-64-VUAL](#) [80.063.4001.1](#) [800-90-001-10-001000](#) [801-43-002-10-013000](#)
[801-43-006-10-002000](#) [803-43-024-10-001000](#) [803-93-012-10-001000](#) [8-1437020-4](#) [819-22-004-30-001101](#) [820-22-006-30-001101](#)
[820-22-008-30-001101](#) [821-22-002-10-001101](#)