

## SOT-23 Plastic-Encapsulate Transistors

### Features

- Complementary to MMBT5401
- Power dissipation of 300mW
- High stability and high reliability
- Meets MSL level 1, per J-STD-020, LF maximum peak of 260°C

### Mechanical Data

- Case: SOT-23  
Molding compound meets UL 94V-0 flammability rating, RoHS-compliant, halogen-free
- Terminals: Solder plated, solderable per MIL-STD-750, Method 2026

### Function Diagram

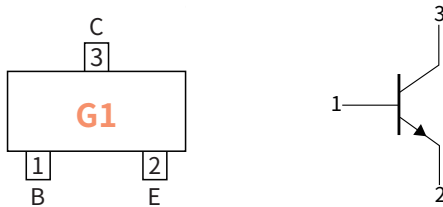

**Collector-Base Voltage**  
VCBO 180V  
**Collector Current**  
0.6 Ampere

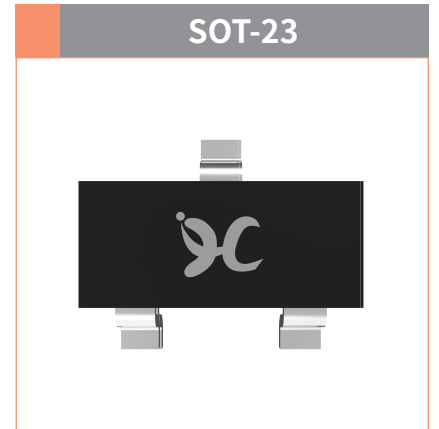

### Maximum Ratings (Ta=25°C Unless otherwise specified)

PARAMETER	SYMBOL	UNIT	VALUE
Collector-Base Voltage	$V_{CBO}$	V	180
Collector-Emitter Voltage	$V_{CEO}$		160
Emitter-Base Voltage	$V_{EBO}$		6.0
Collector Current	$I_C$	A	0.6
Collector Power Dissipation	$P_C$	mW	300
Storage temperature	$T_{stg}$	°C	-55 ~+150
Junction temperature	$T_j$	°C	-55 ~+150
Typical Thermal Resistance	$R_{\theta J-A}$	°C /W	417

### Electrical Characteristics (Ta=25°C Unless otherwise noted)

PARAMETER	SYMBOL	UNIT	Condition	Min	Max
Collector-Base Breakdown Voltage	$V_{(BR)CBO}$	V	$I_C=100\mu A, I_E=0$	180	—
Collector-Emitter Breakdown Voltage	$V_{(BR)CEO}$		$I_C=1.0mA, I_B=0$	160	—
Emitter-Base Breakdown Voltage	$V_{(BR)EBO}$		$I_E=10\mu A, I_C=0$	6.0	—
Collector-Base cut-off current	$I_{CBO}$	nA	$V_{CB}=120V, I_B=0$	—	50
Emitter-Base cut-off current	$I_{EBO}$		$V_{EB}=4.0V, I_C=0$	—	50
DC Current Gain	$h_{FE}$	—	$I_C=1.0mA, V_{CE}=5.0V$	80	—
			$I_C=10mA, V_{CE}=5.0V$	100	300
			$I_C=50mA, V_{CE}=5.0V$	30	—
Collector-Emitter Saturation Voltage	$V_{CE(sat)1}$	V	$I_C=10mA, I_B=1.0mA$	—	0.15
Collector-Emitter Saturation Voltage	$V_{CE(sat)2}$		$I_C=50mA, I_B=5.0mA$	—	0.2
Base-Emitter Saturation Voltage	$V_{BE(sat)1}$		$I_C=10mA, I_B=1.0mA$	—	1.0
Base-Emitter Saturation Voltage	$V_{BE(sat)2}$		$I_C=50mA, I_B=5.0mA$	—	1.0

## ● Small-signal Characteristics

ITEM	SYMBOL	Condition	UNIT	Min	Max
Transition frequency	$f_T$	$I_C=10\text{mA}, V_{CE}=10\text{V}, f=100\text{MHz}$	MHz	100	300

## ● Ordering Information

PACKAGE	PACKAGE CODE	UNIT WEIGHT(g)	REEL(pcs)	BOX(pcs)	CARTON(pcs)	DELIVERY MODE
SOT-23	R1	0.008	3000	30000	120000	7"

## ● Ratings And Characteristics Curves (Ta=25°C Unless otherwise specified)

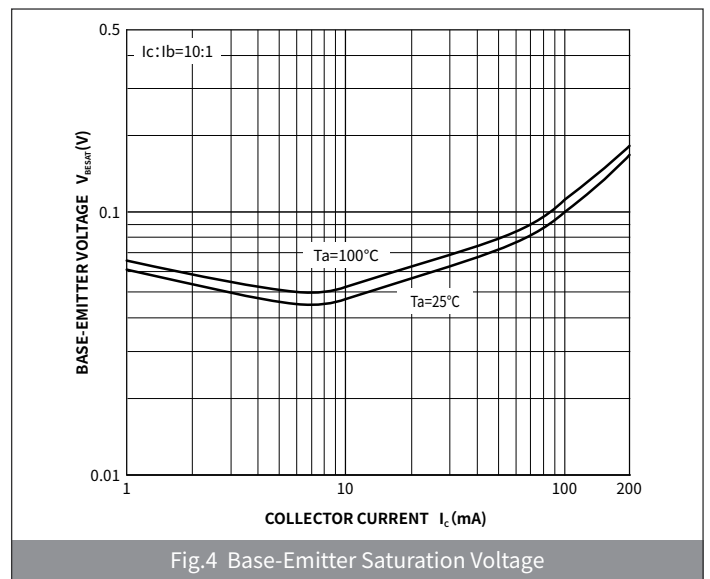
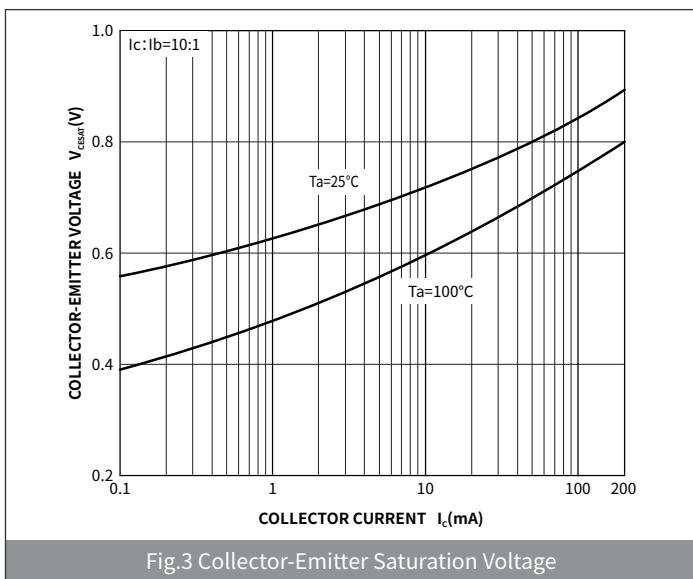
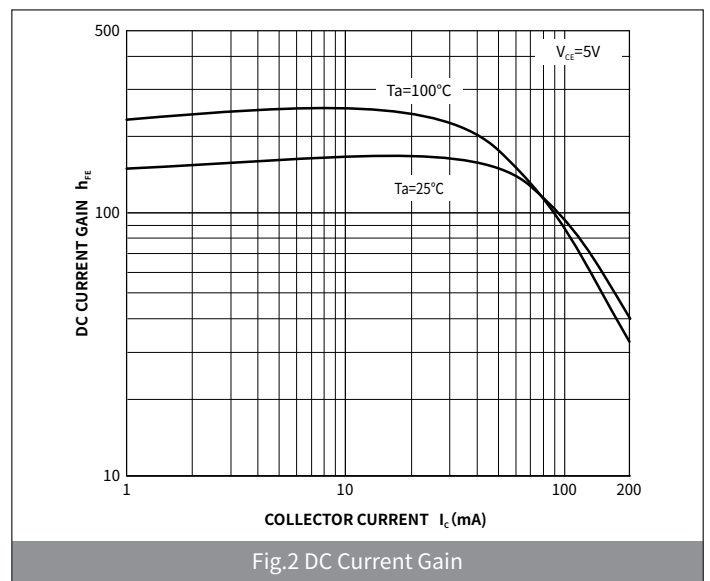
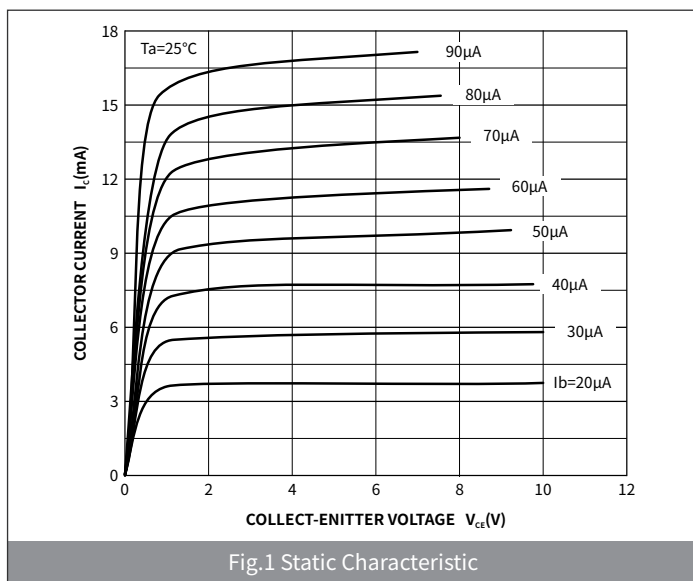

## ● Ratings And Characteristics Curves (Ta=25°C Unless otherwise specified)

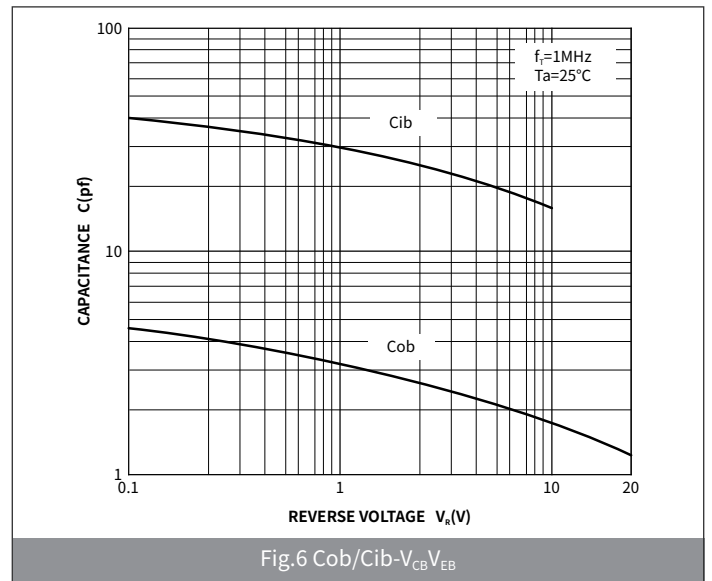
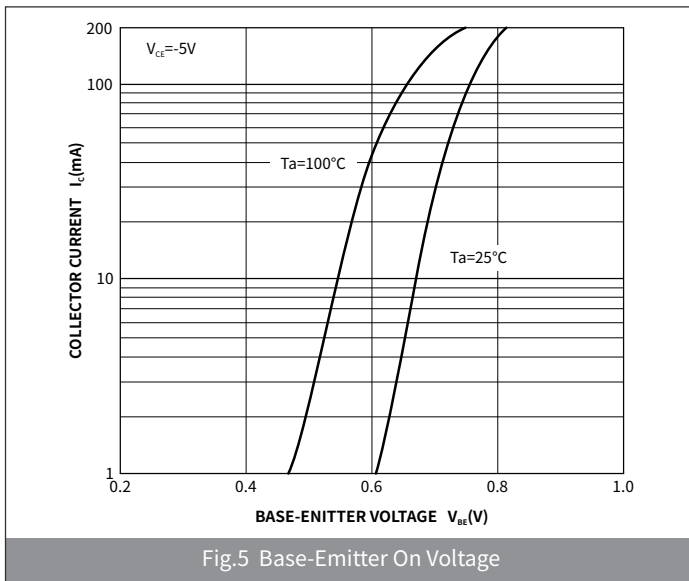

## ● Package Outline Dimensions (SOT-23)

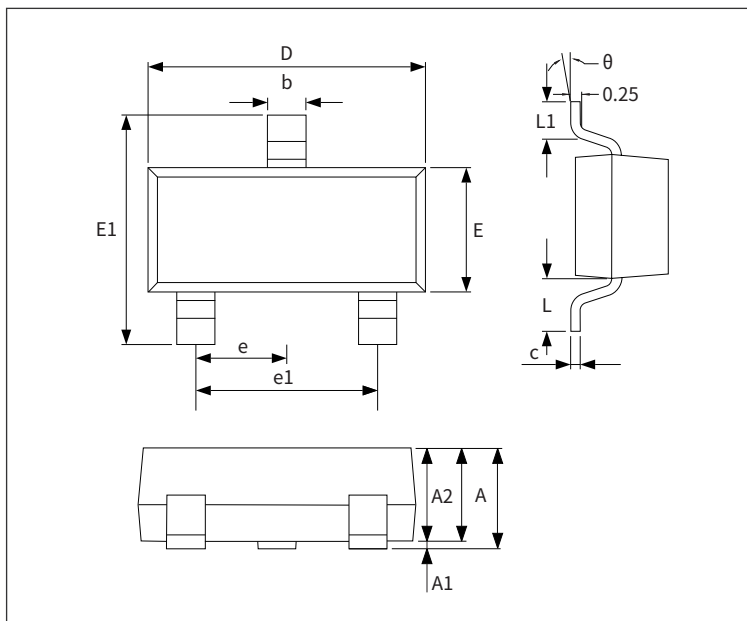

Symbol	Dimensions			
	Millimeters		Inches	
	Min.	Max.	Min.	Max.
A	0.90	1.15	0.035	0.045
A1	-	0.10	-	0.004
A2	0.90	1.05	0.035	0.041
b	0.30	0.50	0.012	0.020
c	0.10	0.20	0.004	0.008
D	2.80	3.00	0.110	0.118
E	1.20	1.40	0.047	0.055
E1	2.25	2.55	0.089	0.100
e	0.950TYP		0.037TYP	
e1	1.80	2.00	0.071	0.079
L	0.550REF		0.022REF	
L1	0.30	0.50	0.012	0.020
θ	-	8°	-	8°

## ● Suggested Pad Layout

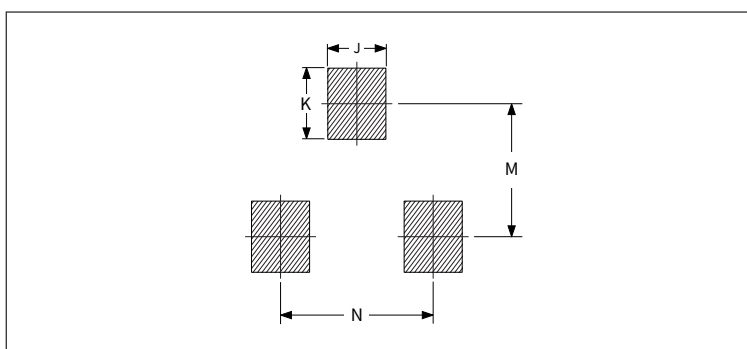

Symbol	Dimensions			
	Millimeters		Inches	
	Min.	Max.	Min.	Max.
J	0.75	0.85	0.030	0.033
K	0.85	0.95	0.033	0.037
M	1.95	2.05	0.077	0.081
N	1.85	1.95	0.073	0.077

## X-ON Electronics

Largest Supplier of Electrical and Electronic Components

*Click to view similar products for [Bipolar Transistors - BJT category](#):*

*Click to view products by [hongjiacheng manufacturer](#):*

Other Similar products are found below :

[BC559C](#) [MCH4017-TL-H](#) [MMBT-2369-TR](#) [BC546/116](#) [NJVMJD148T4G](#) [NTE16](#) [NTE195A](#) [IMX9T110](#) [2N4401-A](#) [2N6728](#) [2SA1419T-TD-H](#) [2SB1204S-TL-E](#) [2SC5488A-TL-H](#) [FMC5AT148](#) [2N2369ADCSM](#) [2N2907A](#) [2N3904-NS](#) [2N5769](#) [2SC4618TLN](#) [CPH6501-TL-E](#) [US6T6TR](#) [BAX18/A52R](#) [BC556/112](#) [IMZ2AT108](#) [MMST8098T146](#) [MCH6102-TL-E](#) [BC846B-13-F](#) [2N3879](#) [30A02MH-TL-E](#) [NTE13](#) [NTE282](#) [NTE323](#) [NTE350](#) [NTE81](#) [JANTX2N2920L](#) [JANSR2N2907AUB](#) [CMLT3946EG TR](#) [SNSS40600CF8T1G](#) [CMLT3906EG TR](#) [GRP-DATA-JANS2N2907AUB](#) [GRP-DATA-JANS2N2222AUA](#) [MMDT3946FL3-7](#) [2N4240](#) [JANS2N3019](#) [MSB30KH-13](#) [2N2221AUB](#) [2SD1815T-TL-E](#) [2N6678](#) [2N2907Ae4](#) [JAN2N3507](#)