

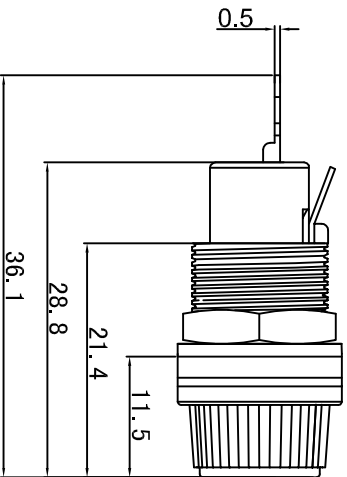

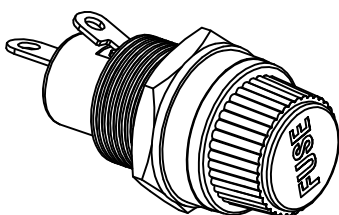

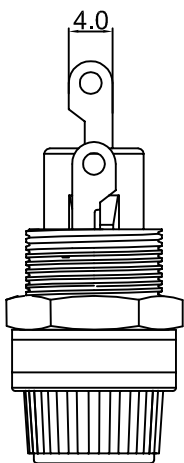

FH1-12

受控文件



MATERIAL:
Housing: PBT, UL rated 94V0
Bayonet: PBT, UL rated 94V0
Terminal: Brass, silver or tin plated
Nut: Brass, Ni plated

Fuse holder for overload protection
Screw-in mounting
Rating: 10A 250VAC (UL, CUL CE)
Fuse: \varnothing 5.0x20mm 
Cap: Screw type 

Panel thickness: 4.5mm max 
Operating Temperature: $-10^{\circ}\text{C} \sim +70^{\circ}\text{C}$

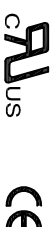

CUT-OUT

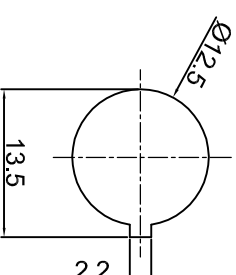

公差 TOLERANCES		.X \pm 0.3 .XX \pm 0.15		角度 ANGLE $\pm 1^{\circ}$		单位 DIMENSION UNIT		mm.	
版本: VERSION		A1		比例尺 SCALE		1:1		品名 TITLE	
重新整理发行		2009.09.05		核对 CHECKED BY		李伟奇		FH1-12-M	
New Issue		2009.02.26		核对 CHECKED BY		李新超		FH1-12_A1	
变更说明 CHANGE DESCRIPTION		日期 DATE		核对 CHECKED BY		李伟奇		图号 DRAWING NO	
版本 VER		EON NO		核对 CHECKED BY		李新超		DRAWING NO	

X-ON Electronics

Largest Supplier of Electrical and Electronic Components

Click to view similar products for [Fuse Holder](#) category:

Click to view products by [HONGJU](#) manufacturer:

Other Similar products are found below :

[570-290-741P40](#) [570-290-751P40](#) [0031.1351.01](#) [020417G](#) [020418E](#) [80910030](#) [8601.2020](#) [9-3557-GP REV A](#) [15600-08-10](#) [BK1-HTC-45M](#)
[BK/FHN19G](#) [BK/HJM-HH](#) [BK/HKP-CCHH](#) [BK/HKP-E-CC](#) [BK/HKP-E-HH](#) [BK/HKP-EH-HH](#) [BK/HKP-U-HH](#) [BK/HTJ-LES-FUSE](#)
[HMG-241](#) [2086-1](#) [2193](#) [RTMF-SC](#) [2602](#) [2650](#) [FHN31G1](#) [G4PB8](#) [2660](#) [2799](#) [CQ-209V](#) [345621A](#) [3794](#) [4202](#) [4408](#) [4413](#) [4423](#) [4482](#)
[4532](#) [4537](#) [TSD1404-12](#) [BK/FHN31G1](#) [BK/HKP-H-CC](#) [BK/HKP-JQ-BB](#) [BK/HKP-JQW-BB](#) [BK/HKP-N-HH](#) [BK/HKP-S-CC](#) [BK/HKP-W-](#)
[BBHH](#) [BP/HHS](#) [BPHHU](#) [55900008011](#) [C1933](#)