

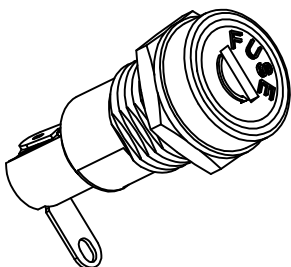

FH1

受控文件

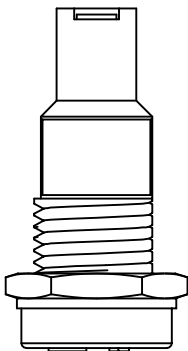

Fuse holder for overload protection

Screw-in mounting

Rating: 10A 250VAC (UL,CUL)

Fuse:Ø5.0x20mm

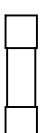

Cap:Bayonet type

Panel thickness:4.5mm max

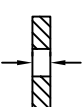

Operating Temperature:-10℃~+70℃

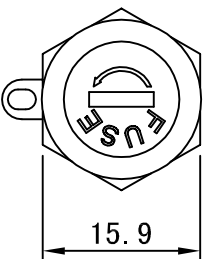
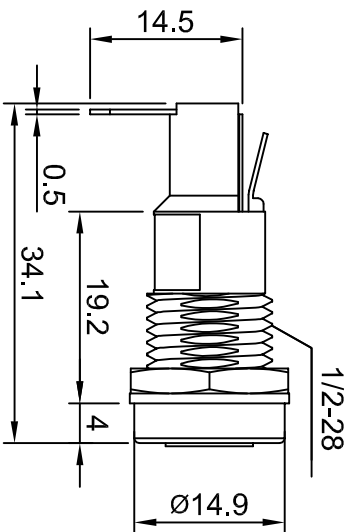

CE

ULus

E240653

CUT-OUT

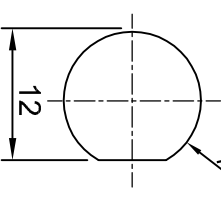

MATERIAL:
Housing:PBT, UL rated 94V2 min
Bayonet:PBT, UL rated 94V2 min
Terminal:Brass, silver or tin plated
Nut:Brass, Ni plated

公差 TOLERANCES		.X±0.3 .XX±0.15		角度 ANGLE ±1°		单位 DIMENSION UNIT		mm.	
版本 VERSION		A1		比例尺 SCALE		1:1		品名 TITLE	
重新整理发行		2009.09.05		核对 CHECKED BY		李伟奇		FH1-B-MW	
New Issue		2009.02.26		核对 CHECKED BY		李伟奇		FH1-B-MW_A1	
变更说明 CHANGE DESCRIPTION		日期 DATE		绘图 DRAWN BY		黄雄阳		图号 DRAWING NO	
版本 VER		ECN NO		核准 APPROVED BY		李新超		版本 VER	

X-ON Electronics

Largest Supplier of Electrical and Electronic Components

Click to view similar products for [Fuse Holder](#) category:

Click to view products by [HONGJU](#) manufacturer:

Other Similar products are found below :

[570-290-741P40](#) [0031.1351.01](#) [020417G](#) [020418E](#) [6R30A1B](#) [6SC30A2IC](#) [80910030](#) [8601.2020](#) [G15A2SPQ](#) [9-3557-GP REV A](#) [HDJ-B](#)
[R6J30A3S](#) [HFH-1](#) [RF30A1S](#) [RF30A2B](#) [RF30A3SP](#) [BK/HHM](#) [HTJ-LES-FUSE](#) [C4044-1](#) [2086-1](#) [2602](#) [2650](#) [178.000100](#) [F60A2SQ](#)
[T30A2B](#) [G4PB8](#) [2660](#) [CQ-209V](#) [HKP-CCHH](#) [R6F30A2S](#) [341001A](#) [345621A](#) [348670](#) [CVRMCC](#) [4202](#) [4407](#) [4408](#) [4413](#) [4423](#) [4532](#) [4537](#)
[TSD1404-12](#) [BPHHU](#) [HPC](#) [55900008011](#) [32NNL](#) [345602-010](#) [345603-010](#) [345612](#) [345903A](#)