

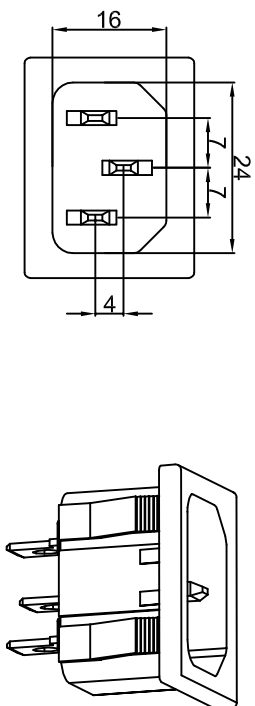



S-03

受控文件



Rating: 15A 250V AC (UL CUL) 
 10A 250V AC (VDE CCC) 
 Insulation Resistance: DC 500V 100M Ω Min.
 Dielectric Strength: AC2000V 1 minute.
 Operating Temperature: -10 °C~+70 °C;
 MATERIAL:
 Body:Nylon66
 Terminal:Brass,Silver or Tin plated

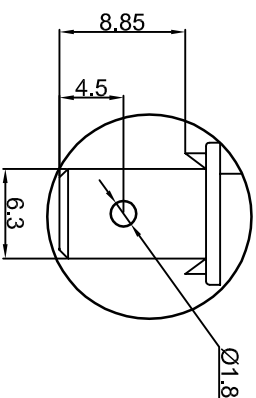
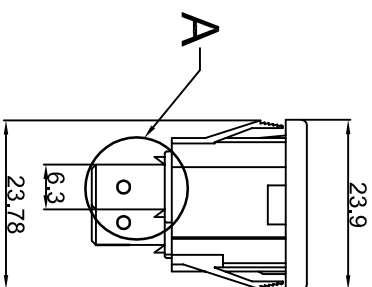
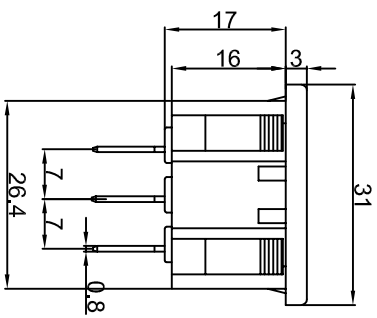

SACLE 2:1

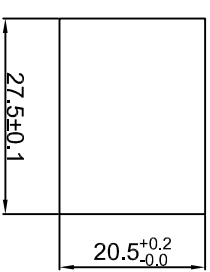

CUT-OUT

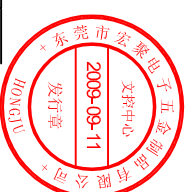

公差 TOLERANCES		X± 0.3		XX± 0.15		角度 ANGLE ± 1°		单位 DIMENSION UNIT		mm.	
版本 VERSION		A1		NONE		日期 DATE		品名 TITLE		图号 DRAWING NO	
批准 APPROVED BY		李新超		核对 CHECKED BY		李伟奇		S-03-12-2		S-03-12-2_A1	
变更说明 CHANGE DESCRIPTION		日期 DATE		ECN NO.		绘图 DRAWN BY		姜庆勇			
A1 图纸重新整理发行		2009.09.04		N/A		2008.07.08					
A0 New Issue		2008.07.08		N/A							
版本 VER.		变更说明 CHANGE DESCRIPTION									

X-ON Electronics

Largest Supplier of Electrical and Electronic Components

Click to view similar products for [DC Power Connectors](#) category:

Click to view products by [HONGJU](#) manufacturer:

Other Similar products are found below :

[1600206-1](#) [163-0308-EX](#) [163-4012-EX](#) [163-4117-EX](#) [163-7421](#) [163-MJ22-EX](#) [171-0721-EX](#) [KLDX-SMT-0202-BPTR](#) [163-0179-EX](#) [163-1000-EX](#) [163-4007-EX](#) [163-4015-EX](#) [171-0722-E](#) [171-7391](#) [K596](#) [KLD-0201-BC](#) [KPPX-D](#) [4C6831AX](#) [TS3PNJ](#) [VLP-12V-1](#) [DC PLUG-P1J-P1MR](#) [09441](#) [AS120-F](#) [09442](#) [AS120-M](#) [09759](#) [CP30240](#) [TAMIYA-M](#) [TAMIYA-MT1](#) [TAMIYA-MT2](#) [4840.1200](#) [4840.2202](#) [C5080HI-04P-18 + C5080HI-C](#) [JC-135](#) [JC-138](#) [JC-210](#) [JC-214](#) [JPO-25 \(FC6814\)](#) [JYO-29 \(FC68102\)](#) [KLS 10 SCHWARZ](#) [KLS 3 SCHWARZ](#) [KPJXHT-4S](#) [WKLS 2](#) [WKLS 40](#) [FA67555](#) [XNES/J 210 SCHWARZ](#) [XNES/J 250 SCHWARZ](#) [FC68026](#) [FC68122C](#) [FC68125](#) [FC68129](#) [FC681375VH](#)