

1SS187 SWITCHING DIODES

FEATURES

Low forward voltage : $V_{F(3)}=0.92V(\text{typ.})$

Fast reverse recovery time : $t_{rr}=1.6ns(\text{typ.})$

MARKING: D3

SOT-23

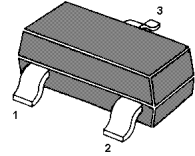

1. CATHODE
2. N. C
3. ANODE

Maximum Ratings @ $T_A=25^\circ\text{C}$

Para	Symbol	Limits	Unit
Non-Repetitive Peak reverse	V_{RM}	85	V
DC Blocking Voltage	V_R	80	V
Forward Continuous Current	I_{FM}	300	mA
Average Rectified Output Current	I_O	100	mA
Power Dissipation	P_D	150	mW
Junction temperature	T_J	125	$^\circ\text{C}$
Storage temperature range	T_{STG}	-55-125	$^\circ\text{C}$

Electrical Characteristics @ $T_A=25^\circ\text{C}$

Para	Symbol	Min.	Typ.	Max.	Unit	Conditions
Reverse Breakdown Voltage	$V_{(BR)R}$	80			V	$I_R=100\mu\text{A}$
Forward voltage	V_{F1}		0.61		V	$I_F=1\text{mA}$
	V_{F2}		0.74		V	$I_F=10\text{mA}$
	V_{F3}		0.92	1.2	V	$I_F=100\text{mA}$
Reverse current	I_{R1}			0.1	μA	$V_R=30\text{V}$
	I_{R2}			0.5	μA	$V_R=80\text{V}$
Capacitance between terminals	C_T		2.2	4.0	pF	$V_R=0, f=1\text{MHz}$
Reverse recovery time	t_{rr}		1.6	4.0	ns	$I_F=I_R=10\text{mA}, I_{rr}=0.1 \times I_R$



Typical Characteristics

ISS187

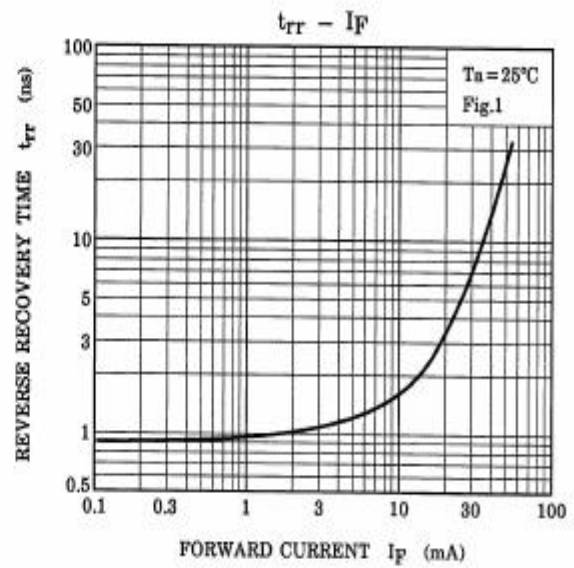
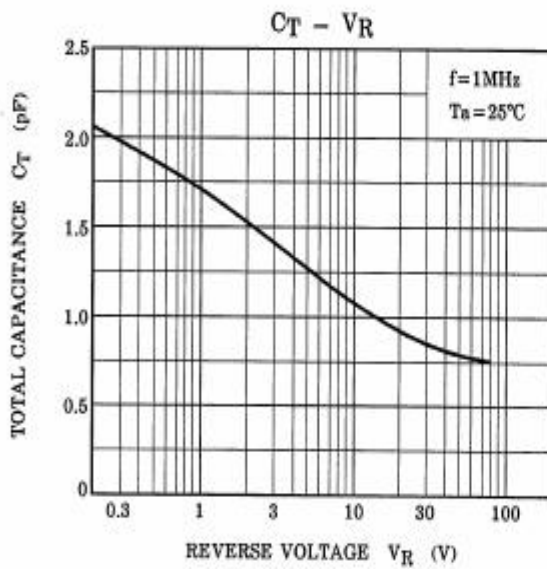
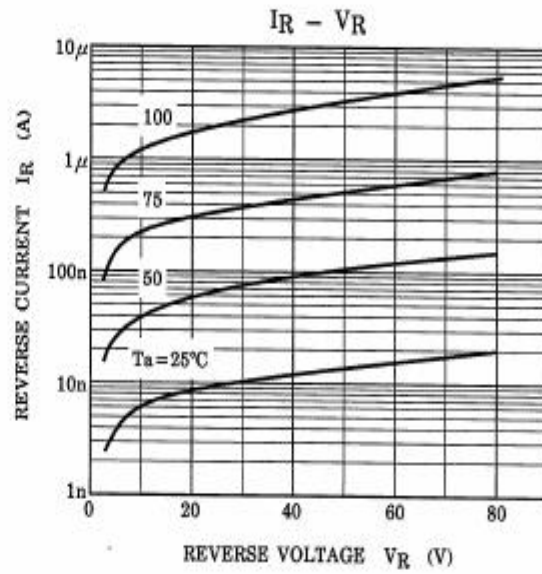
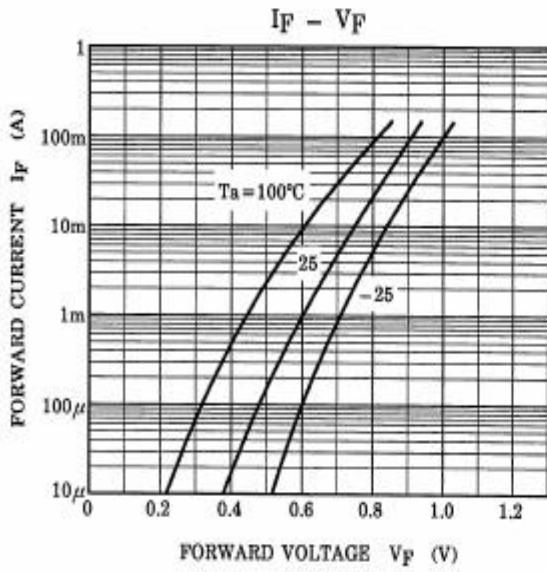



PACKAGE OUTLINE

Plastic surface mounted package; 3 leads

SOT-23

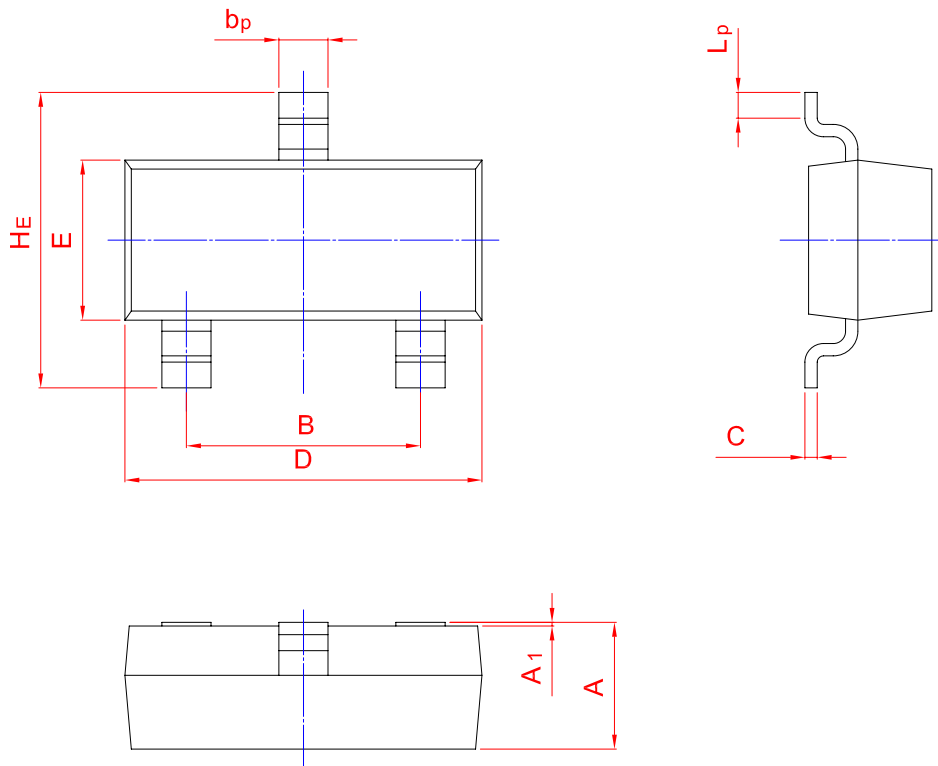
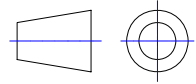

UNIT	A	B	b_p	C	D	E	H_E	A_1	L_p
mm	1.40	2.04	0.50	0.19	3.10	1.65	3.00	0.100	0.50
	0.95	1.78	0.35	0.08	2.70	1.20	2.20	0.013	0.20

X-ON Electronics

Largest Supplier of Electrical and Electronic Components

Click to view similar products for [Diodes - General Purpose, Power, Switching category:](#)

Click to view products by [Hong Kong Chuangji manufacturer:](#)

Other Similar products are found below :

[MCL4151-TR3](#) [MMBD3004S-13-F](#) [RD0306T-H](#) [BAV17-TR](#) [BAV19-TR](#) [1N3611](#) [NTE156A](#) [NTE574](#) [NTE6244](#) [1SS181-TP](#)
[1SS400CST2RA](#) [SDAA13](#) [SHN2D02FUTW1T1G](#) [LS4151GS08](#) [1N4449](#) [1N456A](#) [1N4934-E3/73](#) [1N914B](#) [1N914BTR](#) [1SS226-TP](#)
[RFUH20TB3S](#) [D291S45T](#) [BAV300-TR](#) [BAW56DWQ-7-F](#) [BAW75-TAP](#) [MM230L-CAA](#) [IDW40E65D1](#) [JAN1N3600](#) [JAN1N4153-1](#)
[JAN1N4454-1](#) [JAN1N4454UR-1](#) [LL4151-GS18](#) [053684A](#) [SMMSD4148T3G](#) [707803H](#) [NSVDAN222T1G](#) [CDSZC01100-HF](#) [LL4150-M-08](#)
[1N4454-TR](#) [BAV199E6433HTMA1](#) [BAV70HDW-7](#) [BAS28-7](#) [JANTX1N6640](#) [BAW56HDW-13](#) [BAS28 TR](#) [VS-HFA04SD60STR-M3](#)
[NSVM1MA152WKT1G](#) [1SS388-TP](#) [RGP30D-E3/73](#) [VS-8EWF02S-M3](#)