

SCHOTTKY DIODES

FEATURES

Extremely Fast Switching Speed

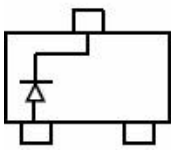
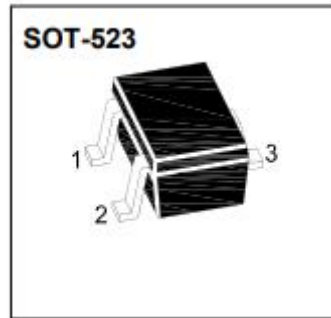

BAT54T MARKING: KL1

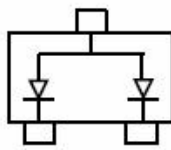

BAT54AT MARKING: KL2

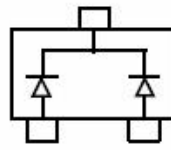

BAT54CT MARKING: KL3

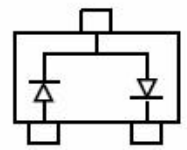

BAT54ST MARKING: KL4

Maximum Ratings @T_A=25°C

Parameter	Symbol	Limits	Unit
Peak Repetitive Peak reverse voltage	V _{RRM}	30	V
Working Peak Reverse Voltage	V _{RWM}		
	V _R		
Forward Continuous Current	I _{FM}	200	mA
Power Dissipation	P _D	200	mW
Storage temperature	T _{STG}	-55-150	°C

Electrical Characteristics @T_A=25°C

Parameter	Symbol	Min.	Typ.	Max.	Unit	Conditions
Reverse Breakdown Voltage	V _{(BR)R}	30			V	I _R =100μA
Forward voltage	V _{F1}			0.24	V	I _F =0.1mA
	V _{F2}			0.32	V	I _F =1mA
	V _{F3}			0.40	V	I _F =10mA
	V _{F4}			0.50	V	I _F =30mA
	V _{F5}			1	V	I _F =100mA
Reverse current	I _R			2	μA	V _R =25V
Diode Capacitance	C _D			10	pF	V _R =1V, f=1MHz
Reverse Recovery Time	t _{rr}			5	nS	I _F =I _R =10mA I _{rr} =0.1X I _R , R _L =100Ω

Typical Characteristics

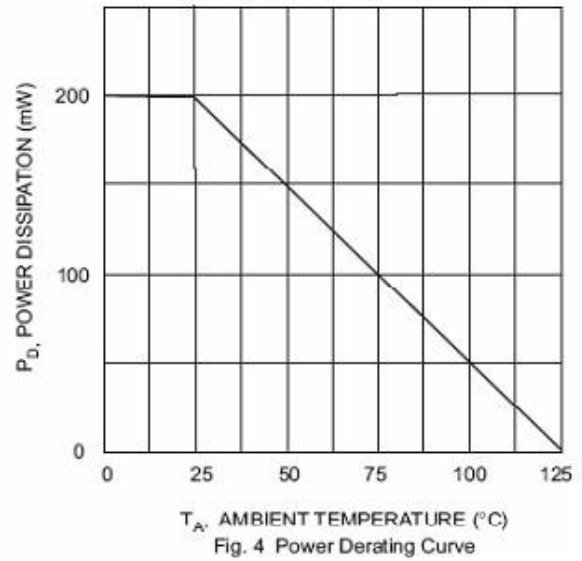
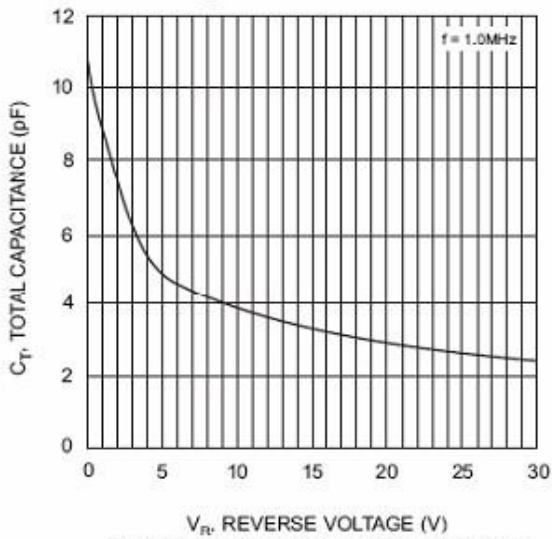
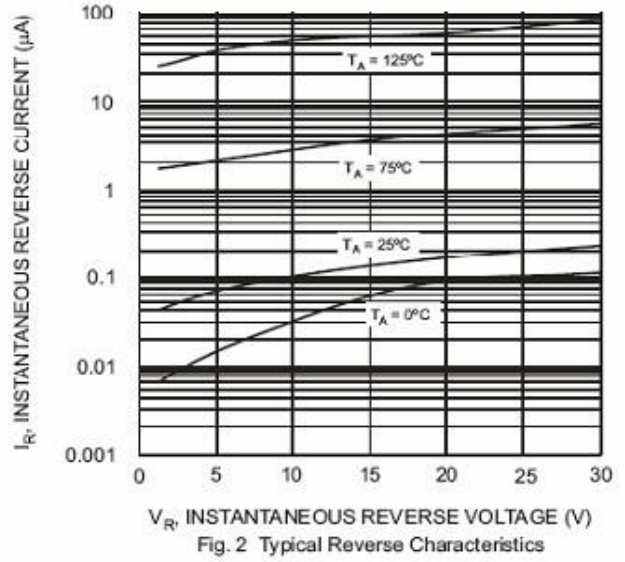
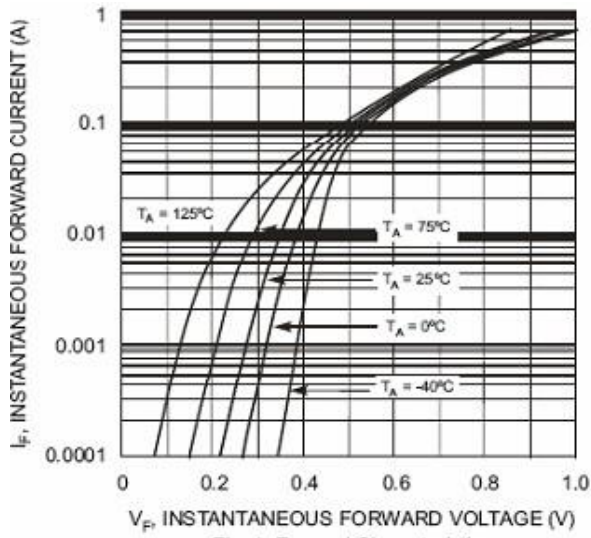

PACKAGE OUTLINE

Plastic surface mounted package; 3 leads

SOT-523

X-ON Electronics

Largest Supplier of Electrical and Electronic Components

Click to view similar products for [Schottky Diodes & Rectifiers](#) category:

Click to view products by [Hong Kong Chuangji](#) manufacturer:

Other Similar products are found below :

[MA4E2039](#) [MA4E2508M-1112](#) [MBR1545CT](#) [MMBD301M3T5G](#) [RB160M-50TR](#) [D83C](#) [BAS16E6433HTMA1](#) [BAT 54-02LRH E6327](#)
[NRVBAF360T3G](#) [NSR05F40QNXT5G](#) [NTE555](#) [JANS1N6640](#) [SK310-T](#) [SK34B-TP](#) [SS3003CH-TL-E](#) [GA01SHT18](#)
[CRS10I30A\(TE85L,QM](#) [MA4E2501L-1290](#) [MBRA140TRPBF](#) [MBRB30H30CT-1G](#) [BAT 15-04R E6152](#) [JANTX1N5712-1](#) [DMJ3940-000](#)
[SB007-03C-TB-E](#) [SK33B-TP](#) [NRVBB20100CTT4G](#) [NRVBM120LT1G](#) [NTSB30U100CT-1G](#) [VS-6CWQ10FNHM3](#) [CRG04\(T5L,TEMQ\)](#)
[ACDBA1100LR-HF](#) [ACDBA1200-HF](#) [ACDBA240-HF](#) [ACDBA3100-HF](#) [CDBQC0530L-HF](#) [CDBQC0240LR-HF](#) [ACDBA260LR-HF](#)
[ACDBA1100-HF](#) [MA4E2502L-1246](#) [10BQ015-M3/5BT](#) [NRVBM120ET1G](#) [CRS08TE85LQM](#) [PMAD1108-LF](#) [B120Q-13-F](#) [1N5819T-G](#)
[B0530WSQ-7-F](#) [PDS1040Q-13](#) [B160BQ-13-F](#) [SDM05U20CSP-7](#) [B140S1F-7](#)