

BAT54T... SCHOTTKY DIODES

FEATURES

Extremely Fast Switching Speed

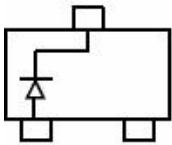
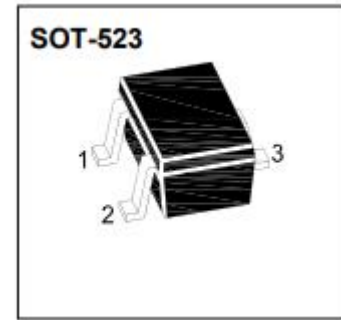

BAT54T MARKING: KL1

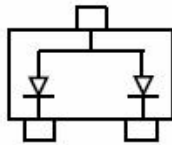

BAT54AT MARKING: KL2

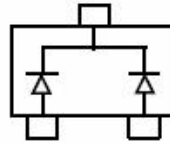

BAT54CT MARKING: KL3

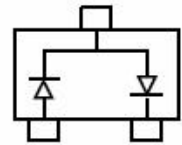

BAT54ST MARKING: KL4

Maximum Ratings @ $T_A=25^\circ\text{C}$

Parameter	Symbol	Limits	Unit
Peak Repetitive Peak reverse voltage	V_{RRM}	30	V
Working Peak Reverse Voltage	V_{RWM}		
	V_R		
Forward Continuous Current	I_{FM}	200	mA
Power Dissipation	P_D	200	mW
Storage temperature	T_{STG}	-55-150	$^\circ\text{C}$

Electrical Characteristics @ $T_A=25^\circ\text{C}$

Parameter	Symbol	Min.	Typ.	Max.	Unit	Conditions
Reverse Breakdown Voltage	$V_{(BR)R}$	30			V	$I_R=100\mu\text{A}$
Forward voltage	V_{F1}			0.24	V	$I_F=0.1\text{mA}$
	V_{F2}			0.32	V	$I_F=1\text{mA}$
	V_{F3}			0.40	V	$I_F=10\text{mA}$
	V_{F4}			0.50	V	$I_F=30\text{mA}$
	V_{F5}			1	V	$I_F=100\text{mA}$
Reverse current	I_R			2	μA	$V_R=25\text{V}$
Diode Capacitance	C_D			10	pF	$V_R=1\text{V}, f=1\text{MHz}$
Reverse Recovery Time	t_{rr}			5	nS	$I_F=I_R=10\text{mA}$ $I_{rr}=0.1I_R, R_L=100\Omega$



Typical Characteristics

BAT54T/AT/CT/ST

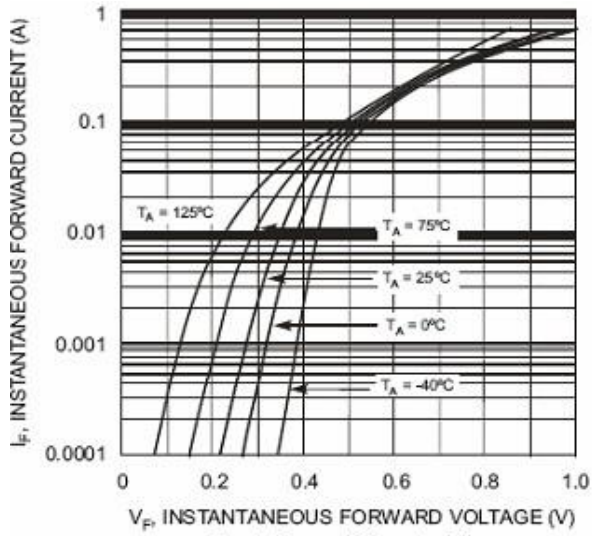

Fig. 1 Forward Characteristics

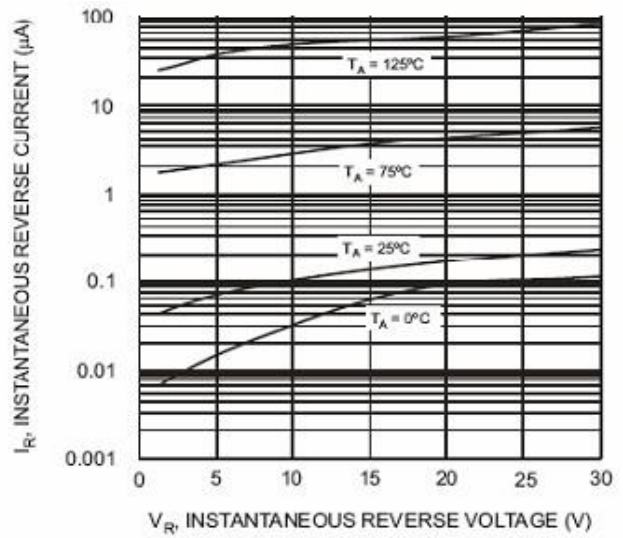

Fig. 2 Typical Reverse Characteristics

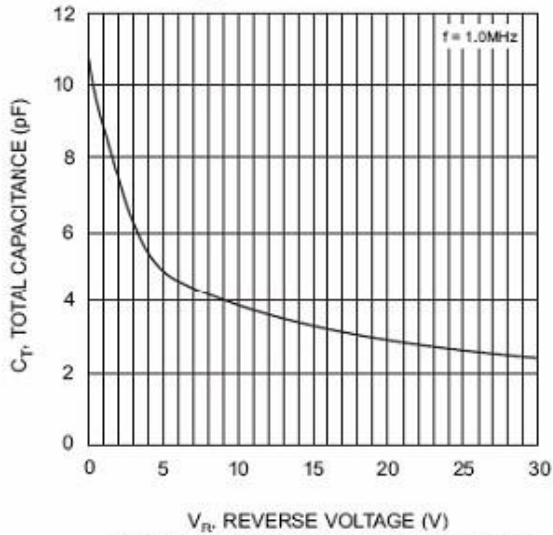

Fig. 3 Typical Capacitance vs. Reverse Voltage

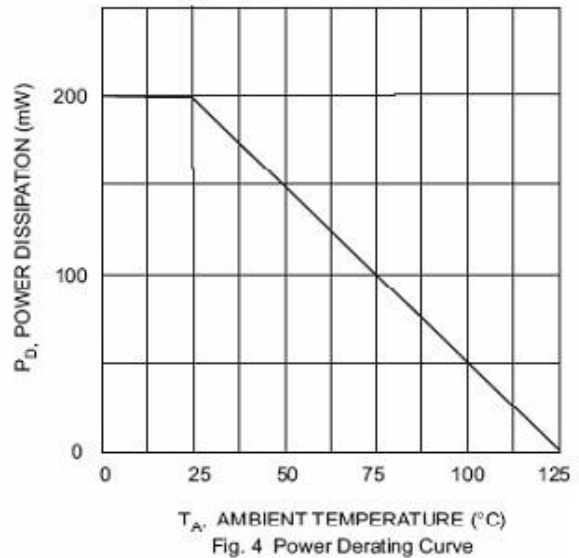
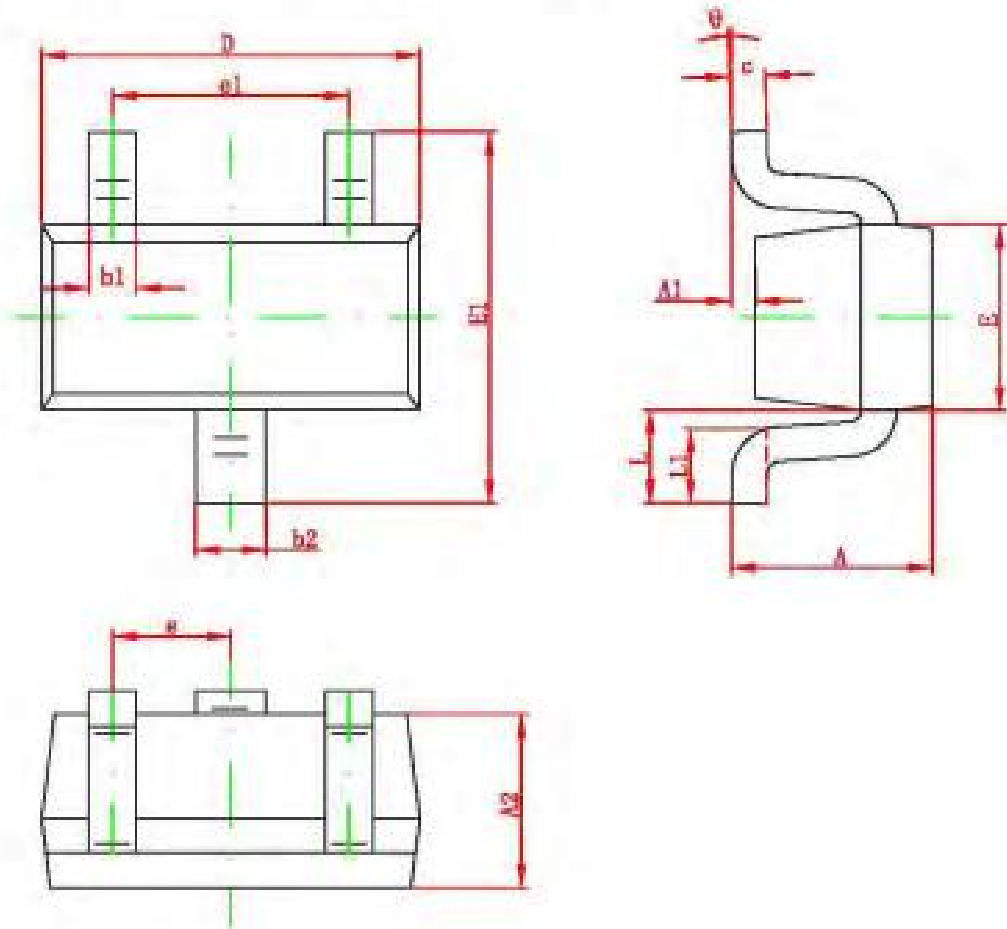

Fig. 4 Power Derating Curve



SOT-523 PACKAGE OUTLINE DIMENSIONS



Symbol	Dimensions in Millimeters		Dimensions in Inches	
	Min.	Max.	Min.	Max.
A	0.700	0.900	0.028	0.035
A1	0.000	0.100	0.000	0.004
A2	0.700	0.800	0.028	0.031
b1	0.150	0.250	0.006	0.010
b2	0.250	0.350	0.010	0.014
c	0.100	0.200	0.004	0.008
D	1.500	1.700	0.059	0.067
E	0.700	0.900	0.028	0.035
E1	1.450	1.750	0.057	0.069
e	0.500 TYP.		0.020 TYP.	
e1	0.900	1.100	0.035	0.043
L	0.400 REF.		0.016 REF.	
L1	0.260	0.460	0.010	0.018
θ	0°	8°	0°	8°

X-ON Electronics

Largest Supplier of Electrical and Electronic Components

Click to view similar products for [Schottky Diodes & Rectifiers](#) category:

Click to view products by [Hong Kong Chuangji](#) manufacturer:

Other Similar products are found below :

[MA4E2039](#) [MA4E2508M-1112](#) [MBR0530L-TP](#) [MBR10100CT-BP](#) [MBR1545CT](#) [MMBD301M3T5G](#) [RB160M-50TR](#)
[BAS16E6433HTMA1](#) [BAS 3010S-02LRH E6327](#) [BAT 54-02LRH E6327](#) [IDL02G65C5XUMA1](#) [NSR05F40QNXT5G](#) [NSVR05F40NXT5G](#)
[NTE555](#) [JANS1N6640](#) [SB07-03C-TB-H](#) [SB1003M3-TL-W](#) [SBM30-03-TR-E](#) [SBS818-TL-E](#) [SK310-T](#) [SK33A-TP](#) [SK34B-TP](#) [SS3003CH-](#)
[TL-E](#) [PDS3100Q-7](#) [GA01SHT18](#) [CRS10I30A\(TE85L,QM](#) [MA4E2501L-1290](#) [MBRA140TRPBF](#) [MBRB30H30CT-1G](#) [JANTX1N5712-1](#)
[SB007-03C-TB-E](#) [SK33B-TP](#) [SK35A-TP](#) [SK38B-LTP](#) [NTE505](#) [NTSB30U100CT-1G](#) [VS-6CWQ10FNHM3](#) [CRG04\(T5L,TEMQ\)](#)
[ACDBA1100LR-HF](#) [ACDBA1200-HF](#) [ACDBA240-HF](#) [ACDBA3100-HF](#) [CDBQC0530L-HF](#) [ACDBA260LR-HF](#) [ACDBA1100-HF](#)
[MA4E2502L-1246](#) [10BQ015-M3/5BT](#) [10BQ060-M3/5BT](#) [NRVB130LSFT1G](#) [CRS08TE85LQM](#)