

# Plastic-Encapsulate Diodes

## SWITCHING DIODE

### FEATURES

- Fast Switching Speed
- For General Purpose Switching Applications
- High Conductance

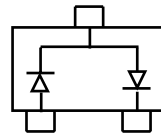
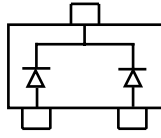
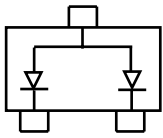
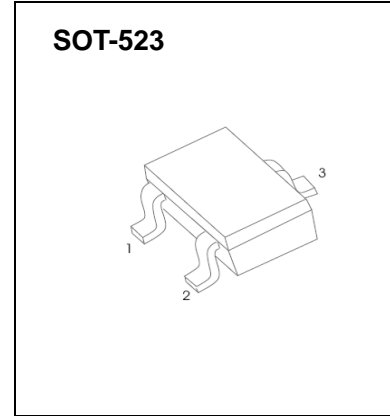

BAW56T Marking: JD

BAV70T Marking: JJ

BAV99T Marking: JE

### Maximum Ratings @Ta=25°C

Parameter	Symbol	Limit	Unit
Reverse voltage	$V_R$	85	V
Forward current	$I_o$	75	mA
Forward power dissipation	$P_D$	150	mW
Junction temperature	$T_j$	150	°C
Storage temperature	$T_{stg}$	-55~+150	°C

### ELECTRICAL CHARACTERISTICS (Ta=25°C unless otherwise specified)

Parameter	Symbol	Test conditions	Min	Max	Unit
Reverse breakdown voltage	$V_{(BR)}$	$I_R=1\mu A$	85		V
Reverse voltage leakage current	$I_{R1}$	$V_R=75V$		2	$\mu A$
	$I_{R2}$	$V_R=25V$		0.03	$\mu A$
Forward voltage	$V_F$	$I_F=1mA$ $I_F=10mA$ $I_F=50mA$ $I_F=150mA$		715 855 1000 1250	mV
Diode capacitance	$C_D$	$V_R=0$ $f=1MHz$		1.5	pF
Reverse recovery time	$t_{rr}$	$I_F=I_R=10mA$ $I_{rr}=0.1 \times I_R, R_L=100\Omega$		4	ns

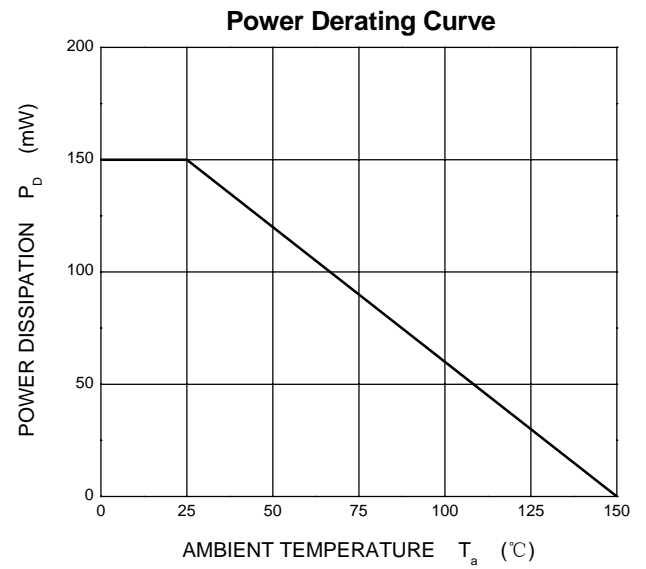
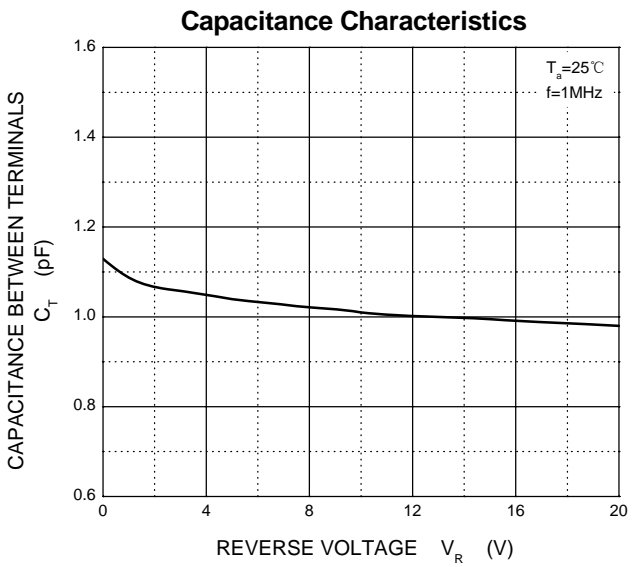
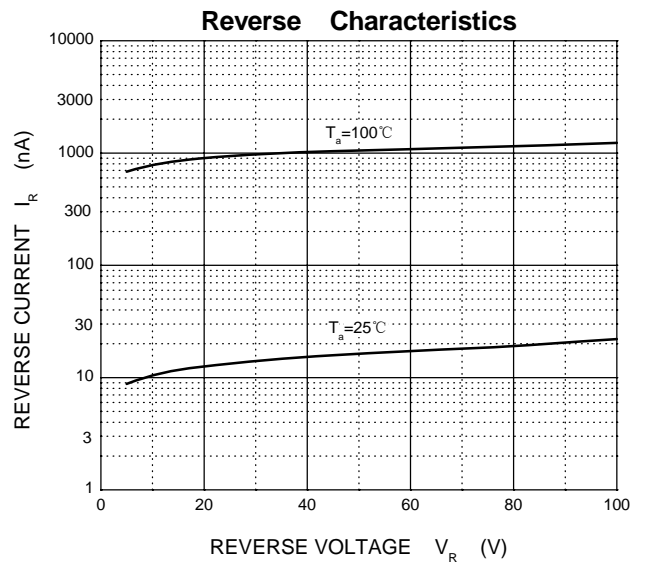
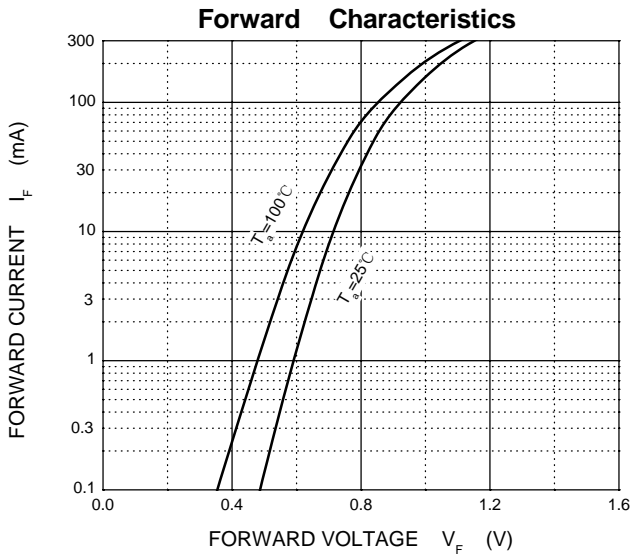

## SOT-523 PACKAGE OUTLINE

## X-ON Electronics

Largest Supplier of Electrical and Electronic Components

*Click to view similar products for* [Diodes - General Purpose, Power, Switching category:](#)

*Click to view products by* [Hong Kong Chuangji manufacturer:](#)

Other Similar products are found below :

[MCL4151-TR3](#) [MMBD3004S-13-F](#) [RD0306T-H](#) [BAV17-TR](#) [BAV19-TR](#) [1N3611](#) [NTE156A](#) [NTE574](#) [NTE6244](#) [1SS181-TP](#)  
[1SS400CST2RA](#) [SDAA13](#) [SHN2D02FUTW1T1G](#) [LS4151GS08](#) [1N4449](#) [1N456A](#) [1N4934-E3/73](#) [1N914B](#) [1N914BTR](#) [1SS226-TP](#)  
[RFUH20TB3S](#) [D291S45T](#) [BAV300-TR](#) [BAW56DWQ-7-F](#) [BAW75-TAP](#) [MM230L-CAA](#) [IDW40E65D1](#) [JAN1N3600](#) [JAN1N4153-1](#)  
[JAN1N4454-1](#) [JAN1N4454UR-1](#) [LL4151-GS18](#) [053684A](#) [SMMSD4148T3G](#) [707803H](#) [NSVDAN222T1G](#) [CDSZC01100-HF](#) [LL4150-M-08](#)  
[1N4454-TR](#) [BAV199E6433HTMA1](#) [BAV70HDW-7](#) [BAS28-7](#) [JANTX1N6640](#) [BAW56HDW-13](#) [BAS28 TR](#) [VS-HFA04SD60STR-M3](#)  
[NSVM1MA152WKT1G](#) [1SS388-TP](#) [RGP30D-E3/73](#) [VS-8EWF02S-M3](#)