

Plastic-Encapsulate Diodes

SWITCHING DIODE

FEATURES

- Fast Switching Speed
- For General Purpose Switching Applications
- High Conductance

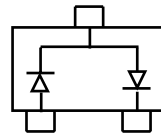
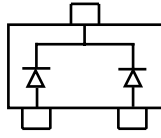
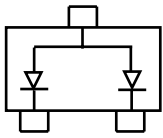
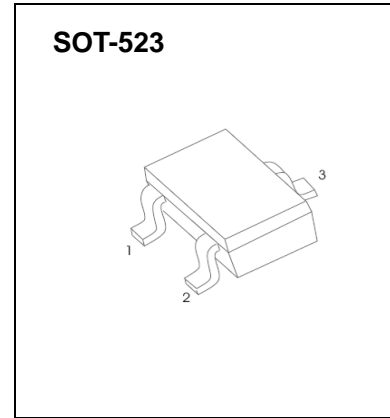

BAW56T Marking: JD

BAV70T Marking: JJ

BAV99T Marking: JE

Maximum Ratings @Ta=25°C

Parameter	Symbol	Limit	Unit
Reverse voltage	V_R	85	V
Forward current	I_o	75	mA
Forward power dissipation	P_D	150	mW
Junction temperature	T_j	150	°C
Storage temperature	T_{stg}	-55~+150	°C

ELECTRICAL CHARACTERISTICS (Ta=25°C unless otherwise specified)

Parameter	Symbol	Test conditions	Min	Max	Unit
Reverse breakdown voltage	$V_{(BR)}$	$I_R=1\mu A$	85		V
Reverse voltage leakage current	I_{R1}	$V_R=75V$		2	μA
	I_{R2}	$V_R=25V$		0.03	μA
Forward voltage	V_F	$I_F=1mA$ $I_F=10mA$ $I_F=50mA$ $I_F=150mA$		715 855 1000 1250	mV
Diode capacitance	C_D	$V_R=0$ $f=1MHz$		1.5	pF
Reverse recovery time	t_{rr}	$I_F=I_R=10mA$ $I_{rr}=0.1 \times I_R, R_L=100\Omega$		4	ns

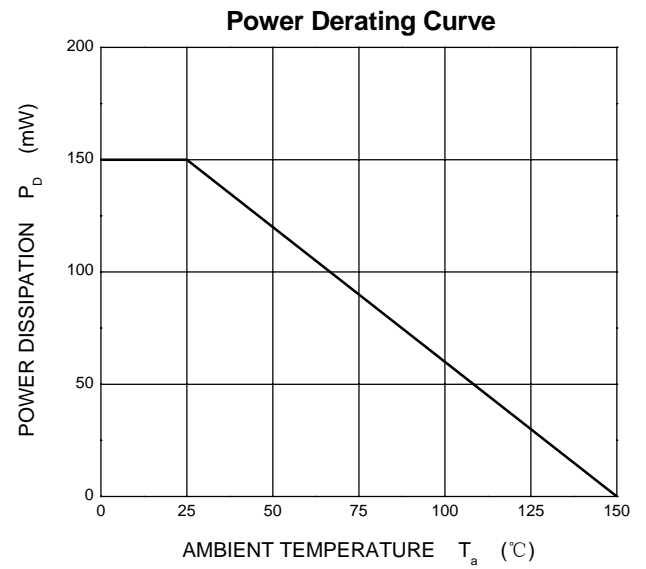
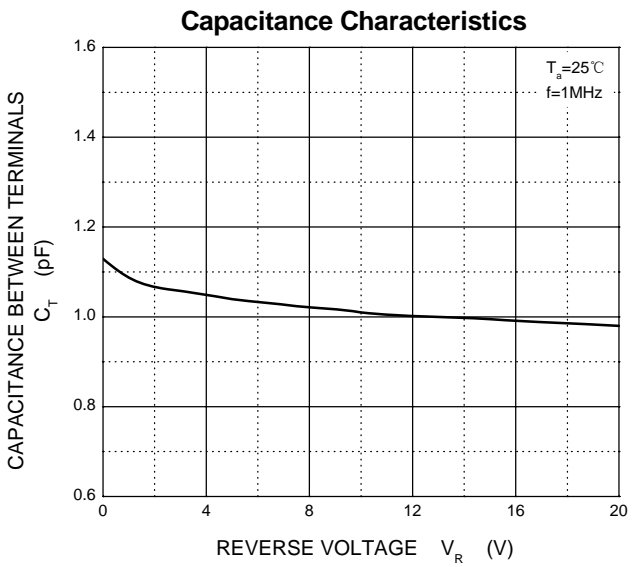
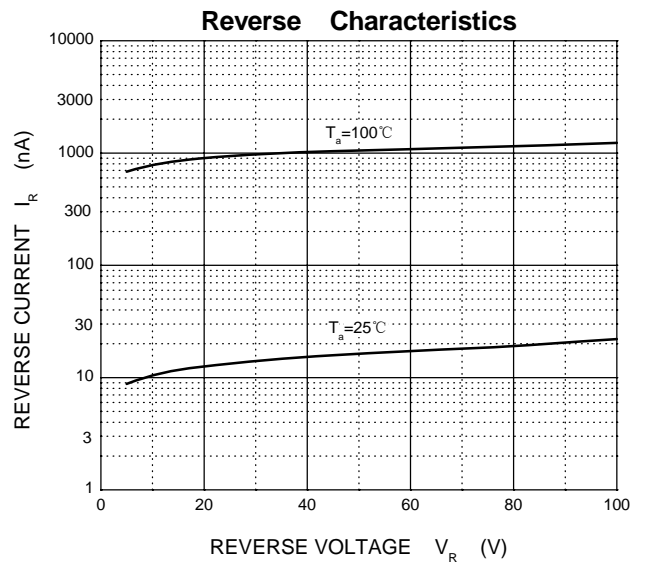
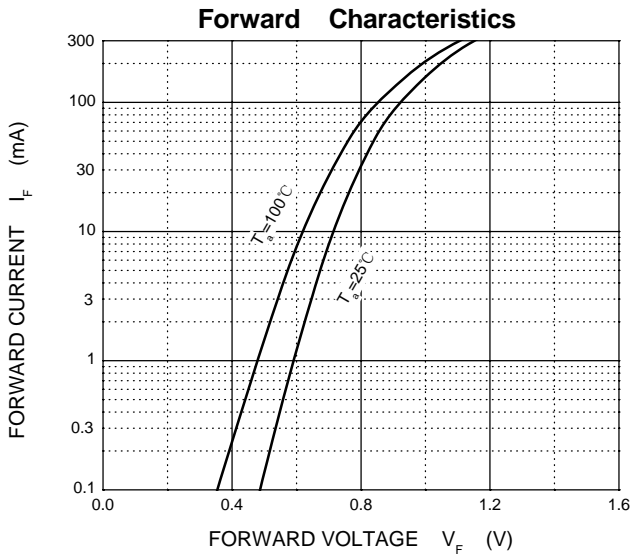

SOT-523 PACKAGE OUTLINE

X-ON Electronics

Largest Supplier of Electrical and Electronic Components

Click to view similar products for [Diodes - General Purpose, Power, Switching category:](#)

Click to view products by [Hong Kong Chuangji manufacturer:](#)

Other Similar products are found below :

[MCL4151-TR3](#) [MMBD3004S-13-F](#) [RD0306T-H](#) [1N3611](#) [NTE156A](#) [NTE574](#) [NTE6244](#) [1SS193,LF](#) [1SS400CST2RA](#) [SDAA13](#)
[SHN2D02FUTW1T1G](#) [LS4151GS08](#) [1N4449](#) [1N456A](#) [1N4934-E3/73](#) [1N914BTR](#) [RFUH20TB3S](#) [D291S45T](#) [BAV300-TR](#) [BAW56DWQ-](#)
[7-F](#) [BAW56M3T5G](#) [BAW75-TAP](#) [MM230L-CAA](#) [IDW40E65D1](#) [JAN1N3600](#) [JAN1N4454UR-1](#) [LL4151-GS18](#) [SMMSD4148T3G](#)
[BYW95B/A52A](#) [NSVDAN222T1G](#) [CDSZC01100-HF](#) [LL4150-M-08](#) [1N4454-TR](#) [BAV70HDW-7](#) [BAS28-7](#) [JANTX1N6640](#) [BAW56HDW-](#)
[13](#) [BAS28 TR](#) [VS-HFA04SD60STR-M3](#) [NSVM1MA152WKT1G](#) [1SS388-TP](#) [RGP30D-E3/73](#) [VS-8EWF02S-M3](#) [BAV99TQ-13-F](#)
[BAV99HDW-13](#) [MMDB30-E28X](#) [IDP20C65D2XKSA1](#) [LS4148](#) [IDV15E65D2](#) [NSVM1MA152WAT1G](#)