

SOT-323 Plastic-Encapsulate Transistors

TRANSISTOR (PNP)

FEATURES

- Ideally suited for automatic insertion
- Epitaxial planar die construction
- Complementary to BC817W

MAXIMUM RATINGS (T_a=25°C unless otherwise noted)

Symbol	Parameter	Value	Unit
V _{CB0}	Collector-Base Voltage	-50	V
V _{CEO}	Collector-Emitter Voltage	-45	V
V _{EBO}	Emitter-Base Voltage	-5	V
I _C	Collector Current	-500	mA
P _C	Collector Power Dissipation	200	mW
R _{θJA}	Thermal Resistance From Junction To Ambient	417	°C/W
T _j	Junction Temperature	150	°C
T _{stg}	Storage Temperature	-55~+150	°C

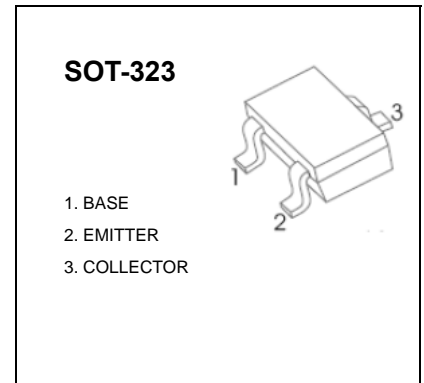

ELECTRICAL CHARACTERISTICS (T_a=25°C unless otherwise specified)

Parameter	Symbol	Test conditions	Min	Max	Unit
Collector-base breakdown voltage	V _{CB0}	I _C =-10μA, I _E =0	-50		V
Collector-emitter breakdown voltage	V _{CEO}	I _C =-10mA, I _B =0	-45		V
Emitter-base breakdown voltage	V _{EBO}	I _E =-1μA, I _C =0	-5		V
Collector cut-off current	I _{CBO}	V _{CB} =-20 V, I _E =0		-0.1	μA
Collector cut-off current	I _{CEO}	V _{CE} =-20 V, I _B =0		-0.2	μA
Emitter cut-off current	I _{EBO}	V _{EB} =-5 V, I _C =0		-0.1	μA
DC current gain	h _{FE(1)}	V _{CE} =-1V, I _C =-100mA	100	600	
	h _{FE(2)}	V _{CE} =-1V, I _C =-500mA	40		
Collector-emitter saturation voltage	V _{CE(sat)}	I _C =-500mA, I _B =-50 mA		-0.7	V
Base-emitter voltage	V _{BE(on)}	V _{CE} =-1V, I _C =-500mA		-1.2	V
Transition frequency	f _T	V _{CE} =-5 V, I _C =-10mA f=100MHz	80		MHz
Collector output capacitance	C _{ob}	V _{CB} =-10V, f=1MHz		10	pF

CLASSIFICATION of h_{FE(1)}

Rank	BC807-16W	BC807-25W	BC807-40W
Range	100-250	160-400	250-600
Marking	5A	5B	5C

Typical Characteristics

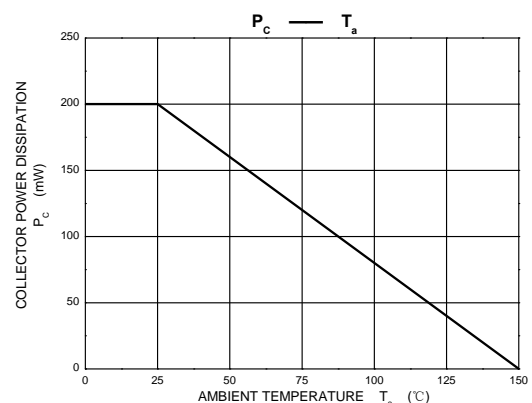
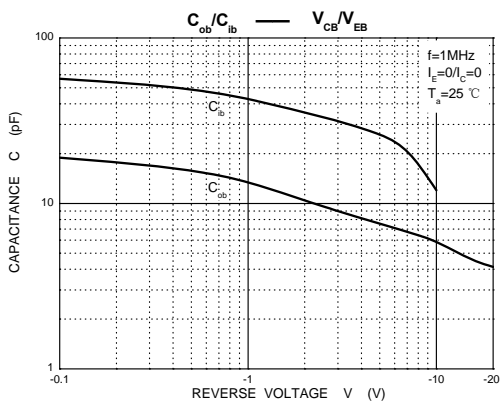
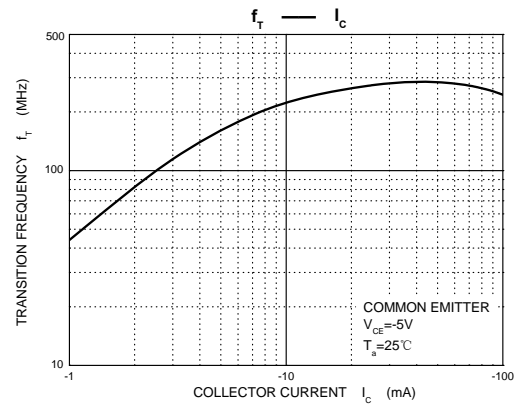
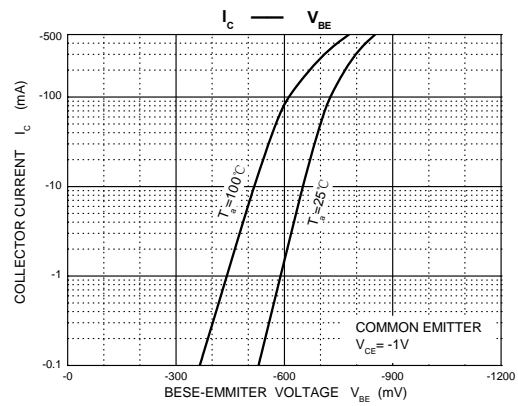
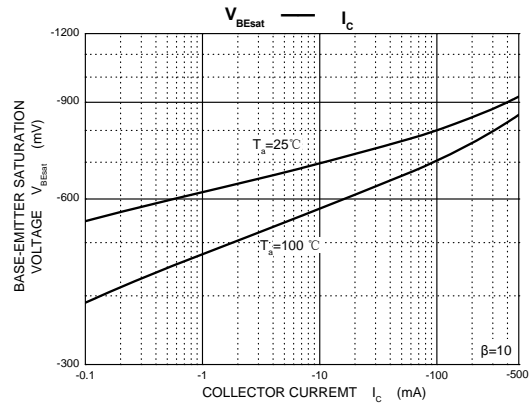
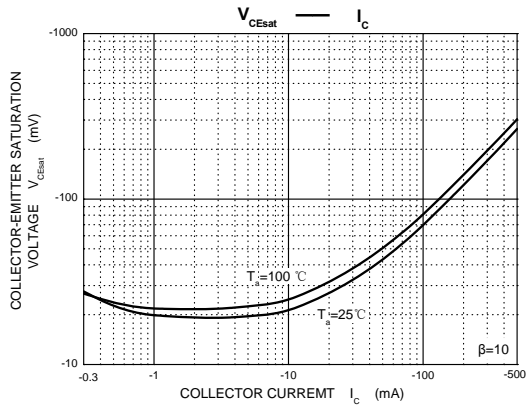
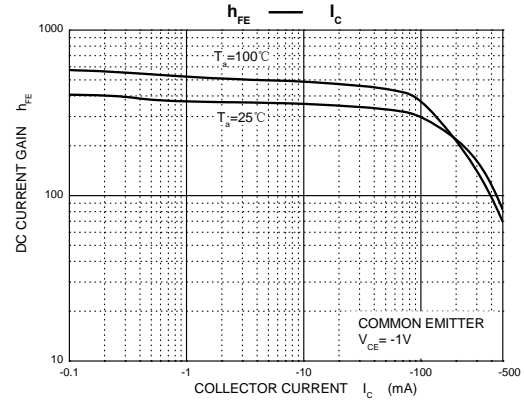
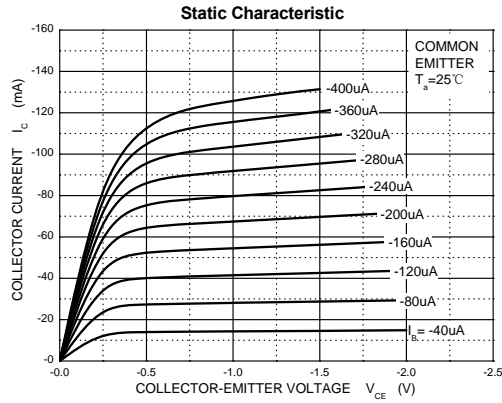

SOT-323 Package Outline Dimensions

X-ON Electronics

Largest Supplier of Electrical and Electronic Components

Click to view similar products for [Bipolar Transistors - BJT category](#):

Click to view products by [Hong Kong Chuangji manufacturer](#):

Other Similar products are found below :

[BC559C](#) [MCH4017-TL-H](#) [MMBT-2369-TR](#) [BC546/116](#) [NJVMJD148T4G](#) [NTE16](#) [NTE195A](#) [IMX9T110](#) [2N4401-A](#) [2N6728](#) [2SA1419T-TD-H](#) [2SB1204S-TL-E](#) [2SC5488A-TL-H](#) [FMC5AT148](#) [2N2369ADCSM](#) [2N2907A](#) [2N3904-NS](#) [2N5769](#) [2SC4618TLN](#) [CPH6501-TL-E](#) [US6T6TR](#) [BAX18/A52R](#) [BC556/112](#) [IMZ2AT108](#) [MMST8098T146](#) [MCH6102-TL-E](#) [BC846B-13-F](#) [2N3879](#) [30A02MH-TL-E](#) [NTE13](#) [NTE282](#) [NTE323](#) [NTE350](#) [NTE81](#) [JANTX2N2920L](#) [JANSR2N2907AUB](#) [CMLT3946EG TR](#) [SNSS40600CF8T1G](#) [CMLT3906EG TR](#) [GRP-DATA-JANS2N2907AUB](#) [GRP-DATA-JANS2N2222AUA](#) [MMDT3946FL3-7](#) [2N4240](#) [JANS2N3019](#) [MSB30KH-13](#) [2N2221AUB](#) [2SD1815T-TL-E](#) [2N6678](#) [2N2907Ae4](#) [JAN2N3507](#)