

SOT-323 Plastic-Encapsulate Transistors

TRANSISTOR (NPN)

FEATURES

- For General AF Applications
- High Collector Current
- High Current Gain
- Low Collector-Emitter Saturation Voltage

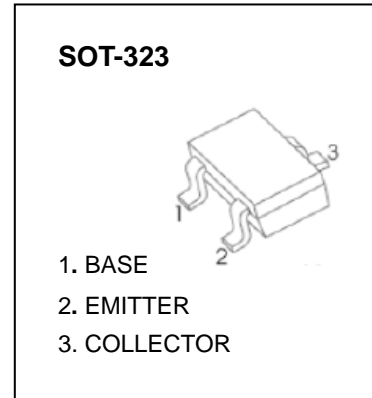

MAXMUM RATINGS (T_a=25°C unless otherwise noted)

Symbol	Parameter	Value	Unit
V _{CB0}	Collector-Base Voltage	50	V
V _{CEO}	Collector-Emitter Voltage	45	V
V _{EBO}	Emitter-Base Voltage	5	V
I _C	Collector Current -Continuous	0.5	A
P _C	Collector Dissipation	0.2	W
R _{θJA}	Thermal Resistance from Junction to Ambient	625	°C/W
T _j	Junction Temperature	150	°C
T _{stg}	Storage Temperature	-55~+150	°C

ELECTRICAL CHARACTERISTICS(T_a=25°C unless otherwise specified)

Parameter	Symbol	Test conditions	Min	Typ	Max	Unit
Collector-base breakdown voltage	V _{(BR)CBO}	I _C =10μA, I _E =0	50			V
Collector-emitter breakdown voltage	V _{(BR)CEO}	I _C =10mA, I _B =0	45			V
Emitter-base breakdown voltage	V _{(BR)EBO}	I _E =1μA, I _C =0	5			V
Collector cut-off current	I _{CBO}	V _{CB} =20V, I _E =0			0.1	μA
Emitter cut-off current	I _{EBO}	V _{EB} =5V, I _C =0			0.1	μA
DC current gain	h _{FE(1)}	V _{CE} =1V, I _C =100mA	100		600	
	h _{FE(2)}	V _{CE} =1V, I _C =500mA	40			
Collector-emitter saturation voltage	V _{CE(sat)}	I _C =500mA, I _B =50mA			0.7	V
Base-emitter saturation voltage	V _{BE(sat)}	I _C =500mA, I _B =50mA			1.2	V
Base-emitter voltage	V _{BE(ON)}	V _{CE} =1V, I _C =500mA			1.2	V
Transition frequency	f _T	V _{CE} =5V, I _C =10mA, f=100MHz	100			MHz
Collector output capacitance	C _{ob}	V _{CB} =10V, f=1MHz			5	pF

CLASSIFICATION of h_{FE(1)}

Rank	BC817-16W	BC817-25W	BC817-40W
Range	100-250	160-400	250-600
Marking	6A	6B	6C

Typical Characteristics

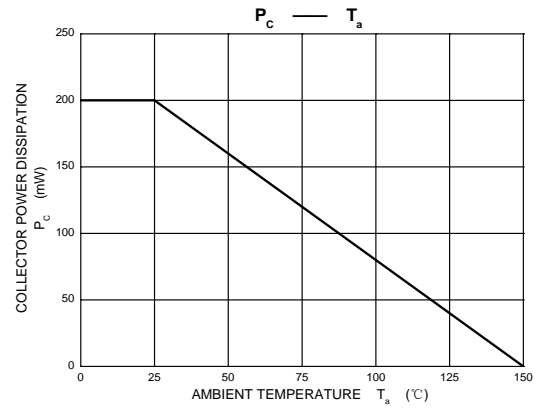
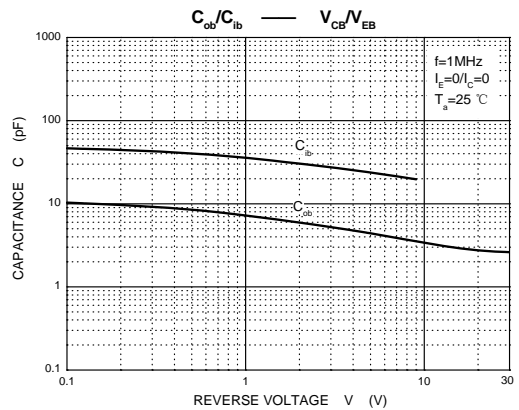
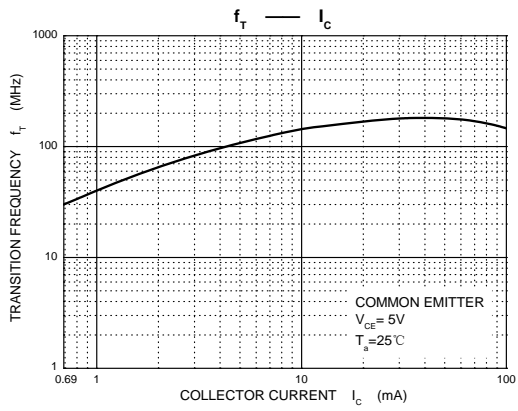
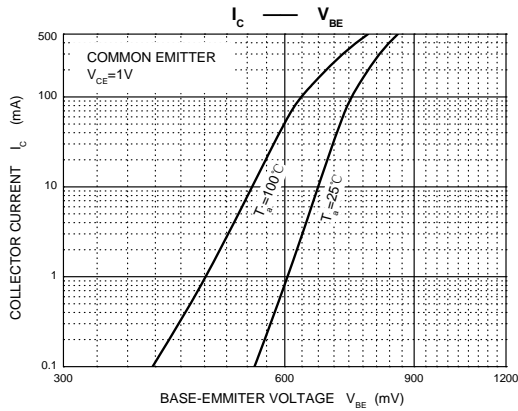
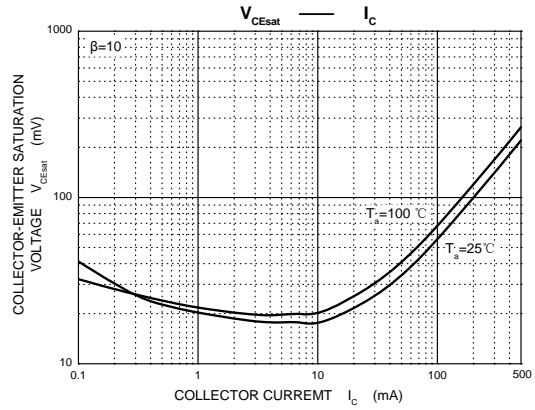
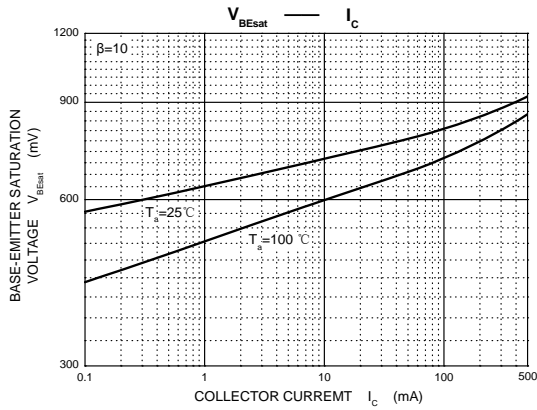
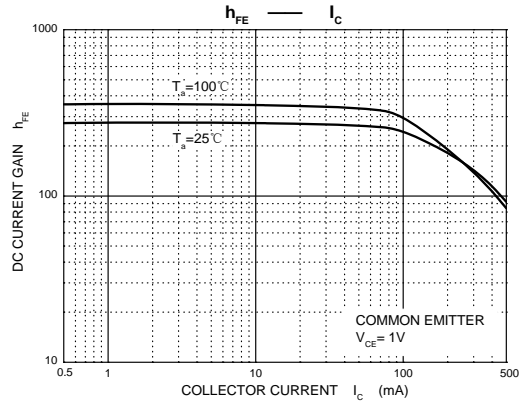
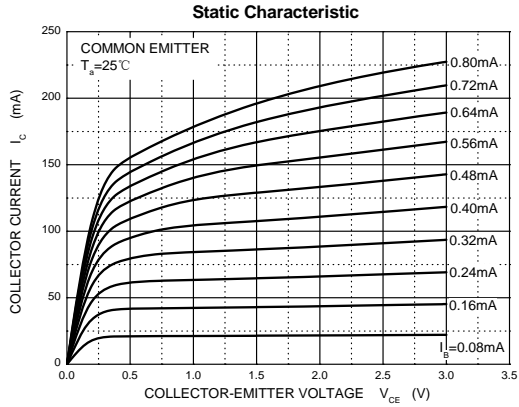

SOT-323 PACKAGE OUTLINE DIMENSIONS

X-ON Electronics

Largest Supplier of Electrical and Electronic Components

Click to view similar products for [Bipolar Transistors - BJT category](#):

Click to view products by [Hong Kong Chuangji manufacturer](#):

Other Similar products are found below :

[BC559C](#) [MCH4017-TL-H](#) [MMBT-2369-TR](#) [BC546/116](#) [NJVMJD148T4G](#) [NTE16](#) [NTE195A](#) [IMX9T110](#) [2N4401-A](#) [2N6728](#) [2SA1419T-TD-H](#) [2SB1204S-TL-E](#) [2SC5488A-TL-H](#) [FMC5AT148](#) [2N2369ADCSM](#) [2N2907A](#) [2N3904-NS](#) [2N5769](#) [2SC4618TLN](#) [CPH6501-TL-E](#) [US6T6TR](#) [BAX18/A52R](#) [BC556/112](#) [IMZ2AT108](#) [MMST8098T146](#) [MCH6102-TL-E](#) [BC846B-13-F](#) [2N3879](#) [30A02MH-TL-E](#) [NTE13](#) [NTE282](#) [NTE323](#) [NTE350](#) [NTE81](#) [JANTX2N2920L](#) [JANSR2N2907AUB](#) [CMLT3946EG TR](#) [SNSS40600CF8T1G](#) [CMLT3906EG TR](#) [GRP-DATA-JANS2N2907AUB](#) [GRP-DATA-JANS2N2222AUA](#) [MMDT3946FL3-7](#) [2N4240](#) [JANS2N3019](#) [MSB30KH-13](#) [2N2221AUB](#) [2SD1815T-TL-E](#) [2N6678](#) [2N2907Ae4](#) [JAN2N3507](#)