

## BZX84C...Series Silicon Planar Zener Diodes

This series of Zener diodes is offered in the convenient, surface mount plastic SOT-23 package. These devices are designed to provide voltage regulation with minimum space requirement. They are well suited for applications such as cellular phones, hand held portables, and high density PC boards.

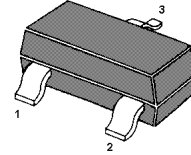
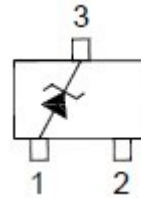

1. Anode 3. Cathode  
SOT-23 Plastic Package

### Features

- Zener breakdown voltage range - 2.0 V to 75 V
- Package designed for optimal automated board assembly
- Small package size for high density applications

### Absolute Maximum Ratings ( $T_a = 25\text{ }^\circ\text{C}$ )

Parameter	Symbol	Value	Unit
Power Dissipation	$P_D$	350	mW
Thermal Resistance, Junction to Ambient <sup>1)</sup>	$R_{\theta JA}$	417	$^\circ\text{C/W}$
Junction and Storage Temperature Range	$T_j, T_{stg}$	- 65 to + 150	$^\circ\text{C}$

<sup>1)</sup> Alumina = 0.4 X 0.3 X 0.024 in, 99.5% alumina



**Electrical Characteristics** (  $T_a = 25\text{ }^\circ\text{C}$  unless otherwise noted,  $V_F < 0.9\text{ V}$  at  $I_F = 10\text{ mA}$ )

Type	Marking Code	Zener Voltage Range <sup>1)</sup>				Dynamic Impedance		Reverse Current	
		$V_{ZT}$			at $I_{ZT}$	$Z_{ZT}$	at $I_{ZT}$	$I_R$	at $V_R$
		Nom. (V)	Min. (V)	Max. (V)	(mA)	Max. ( $\Omega$ )	(mA)	Max. ( $\mu\text{A}$ )	(V)
BZX84C2V0	A8	2	1.8	2.15	5	100	5	120	0.5
BZX84C2V2	B8	2.2	2.08	2.33	5	100	5	120	0.7
BZX84C2V4	C8	2.4	2.2	2.6	5	100	5	50	1
BZX84C2V7	D8	2.7	2.5	2.9	5	100	5	20	1
BZX84C3V0	E8	3	2.8	3.2	5	95	5	10	1
BZX84C3V3	F8	3.3	3.1	3.5	5	95	5	5	1
BZX84C3V6	H8	3.6	3.4	3.8	5	90	5	5	1
BZX84C3V9	J8	3.9	3.7	4.1	5	90	5	3	1
BZX84C4V3	K8	4.3	4	4.6	5	90	5	3	1
BZX84C4V7	M8	4.7	4.4	5	5	80	5	3	2
BZX84C5V1	N8	5.1	4.8	5.4	5	60	5	2	2
BZX84C5V6	P8	5.6	5.2	6	5	40	5	1	2
BZX84C6V2	R8	6.2	5.8	6.6	5	10	5	3	4
BZX84C6V8	X8	6.8	6.4	7.2	5	15	5	2	4
BZX84C7V5	Y8	7.5	7	7.9	5	15	5	1	5
BZX84C8V2	Z8	8.2	7.7	8.7	5	15	5	0.7	5
BZX84C9V1	A9	9.1	8.5	9.6	5	15	5	0.5	6
BZX84C10	B9	10	9.4	10.6	5	20	5	0.2	7
BZX84C11	C9	11	10.4	11.6	5	20	5	0.1	8
BZX84C12	D9	12	11.4	12.7	5	25	5	0.1	8
BZX84C13	E9	13	12.4	14.1	5	30	5	0.1	8
BZX84C15	F9	15	13.8	15.6	5	30	5	0.05	10.5
BZX84C16	H9	16	15.3	17.1	5	40	5	0.05	11.2
BZX84C18	J9	18	16.8	19.1	5	45	5	0.05	12.6
BZX84C20	K9	20	18.8	21.2	5	55	5	0.05	14
BZX84C22	M9	22	20.8	23.3	5	55	5	0.05	15.4
BZX84C24	N9	24	22.8	25.6	5	70	5	0.05	16.8
BZX84C27	P9	27	25.1	28.9	2	80	2	0.05	18.9
BZX84C30	R9	30	28	32	2	80	2	0.05	21
BZX84C33	X9	33	31	35	2	80	2	0.05	23.1
BZX84C36	Y9	36	34	38	2	90	2	0.05	25.2
BZX84C39	Z9	39	37	41	2	130	2	0.05	27.3
BZX84C43	A0	43	40	46	2	150	2	0.05	30.1
BZX84C47	B0	47	44	50	2	170	2	0.05	32.9
BZX84C51	C0	51	48	54	2	180	2	0.05	35.7
BZX84C56	D0	56	52	60	2	200	2	0.05	39.2
BZX84C62	E0	62	58	66	2	215	2	0.05	43.4
BZX84C68	F0	68	64	72	2	240	2	0.05	47.6
BZX84C75	H0	75	70	79	2	255	2	0.05	52.5

<sup>1)</sup> Tested with pulses  $t_p = 20\text{ ms}$ .



Temperature Coefficient

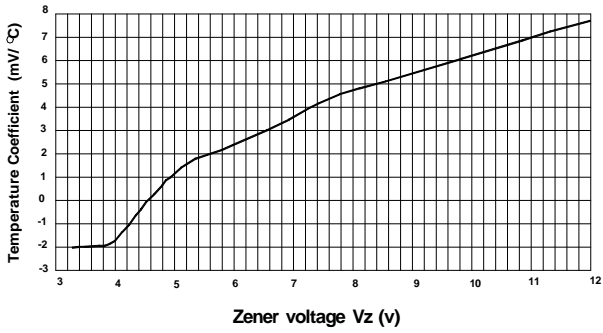

Temperature Coefficient

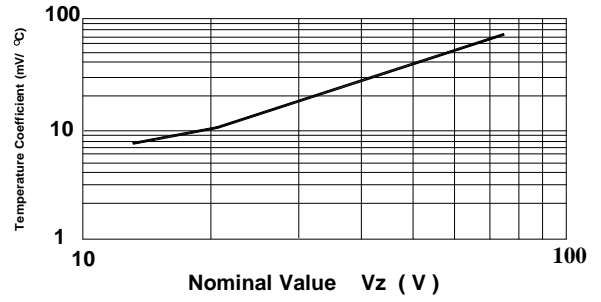

Power Derating Curve

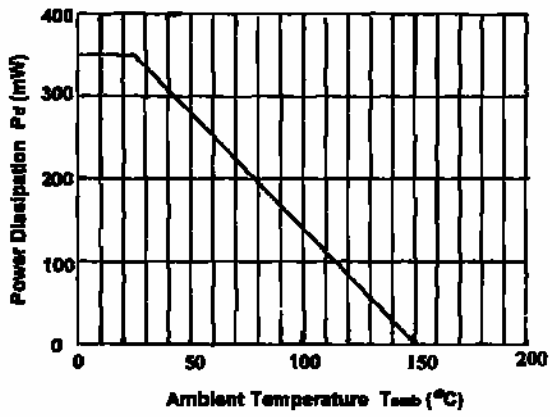

Typical Forward Voltage

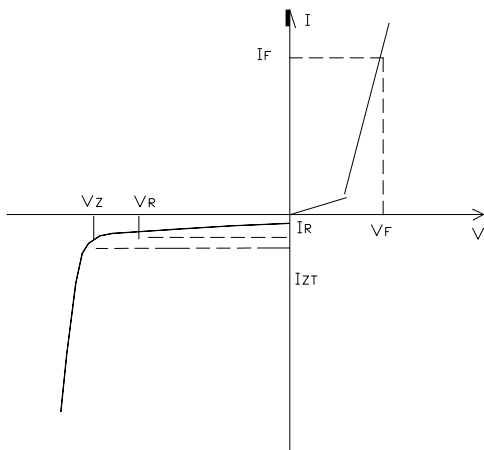
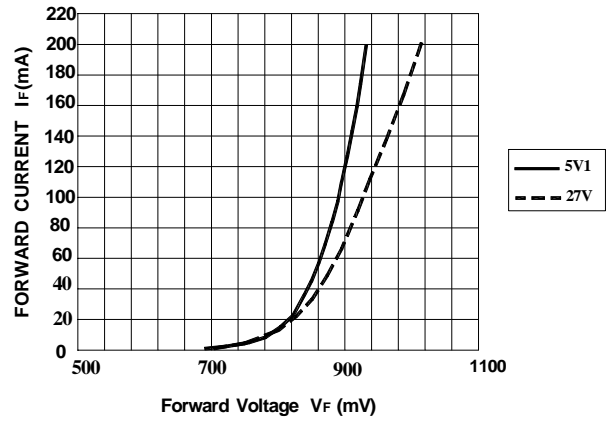

Zener Voltage Regulator



## PACKAGE OUTLINE

Plastic surface mounted package; 3 leads

SOT-23

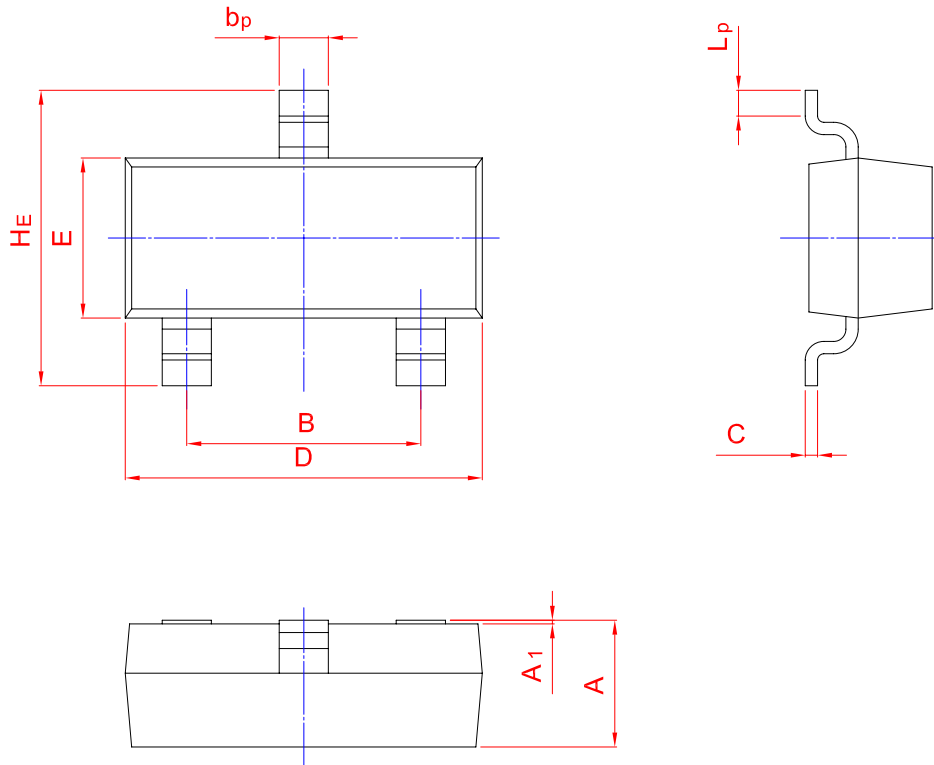
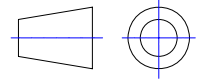

UNIT	A	B	bp	C	D	E	Hε	A1	Lp
mm	1.40	2.04	0.50	0.19	3.10	1.65	3.00	0.100	0.50
	0.95	1.78	0.35	0.08	2.70	1.20	2.20	0.013	0.20

## X-ON Electronics

Largest Supplier of Electrical and Electronic Components

*Click to view similar products for [Zener Diodes](#) category:*

*Click to view products by [Hong Kong Chuangji](#) manufacturer:*

Other Similar products are found below :

[RKZ13B2KG#P1](#) [DL5234B](#) [EDZTE6113B](#) [1N4682](#) [1N4691](#) [1N4693](#) [1N4732A](#) [1N4736A](#) [1N4750A](#) [1N4759ARL](#) [1N5241B](#) [1N5365B](#)  
[1N5369B](#) [1N747A](#) [1N959B](#) [1N964B](#) [1N966B](#) [1N968B](#) [1N972B](#) [NTE5121A](#) [NTE5147A](#) [NTE5152A](#) [NTE5155A](#) [NTE5164A](#)  
[JANS1N4974US](#) [1N4692](#) [1N4700](#) [1N4702](#) [1N4704](#) [1N4711](#) [1N4714](#) [1N4737A](#) [1N4745ARL](#) [1N4752A](#) [1N4752ARL](#) [1N4760ARL](#)  
[1N5221B](#) [1N5236B](#) [1N5241BTR](#) [1N5242BTR](#) [1N5350B](#) [1N5352B](#) [1N961BRR1](#) [1N964BRL](#) [RKZ5.1BKU#P6](#) [3SMAJ5946B-TP](#)  
[3SMAJ5950B-TP](#) [3SMBJ5925B-TP](#) [441774C](#) [BZX84C3V9](#)