

RB551V-30 SILICON EPITAXIAL PLANAR SCHOTTKY BARRIER DIODE

Features

- Small surface mounting type
- Ultra low V_F
- High reliability

Applications

- High frequency rectification switching regulation

PINNING

PIN	DESCRIPTION
1	Cathode
2	Anode

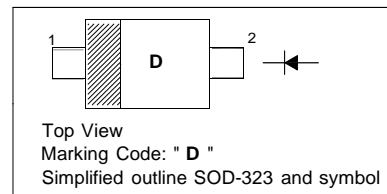

Absolute Maximum Ratings ($T_a = 25\text{ }^\circ\text{C}$)

Parameter	Symbol	Value	Unit
Peak Reverse Voltage	V_{RM}	30	V
DC Reverse Voltage	V_R	20	V
Mean Rectifying Current	I_O	0.5	A
Peak Forward Surge Current (60 Hz for 1 Cyc.)	I_{FSM}	2	A
Junction Temperature	T_j	125	$^\circ\text{C}$
Storage Temperature Range	T_{stg}	- 40 to + 125	$^\circ\text{C}$

Characteristics at $T_a = 25\text{ }^\circ\text{C}$

Parameter	Symbol	Max.	Unit
Forward Voltage at $I_F = 100\text{ mA}$ at $I_F = 500\text{ mA}$	V_F	0.36 0.47	V
Reverse Current at $V_R = 20\text{ V}$	I_R	100	μA

Note: ESD sensitive product handling required.

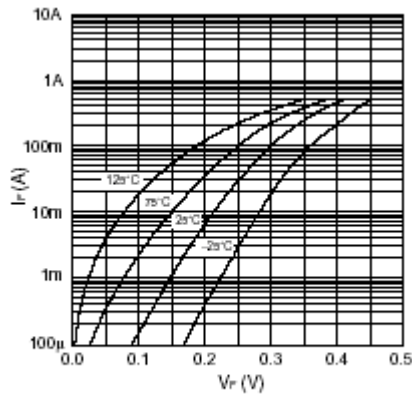

Fig.1 Forward characteristics

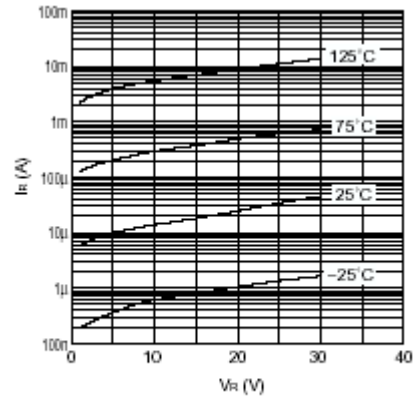

Fig.2 Reverse characteristics

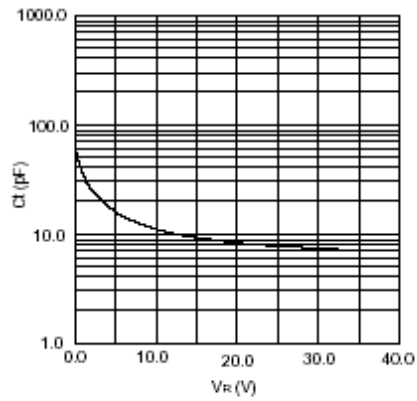

Fig.3 Capacitance between terminals characteristics

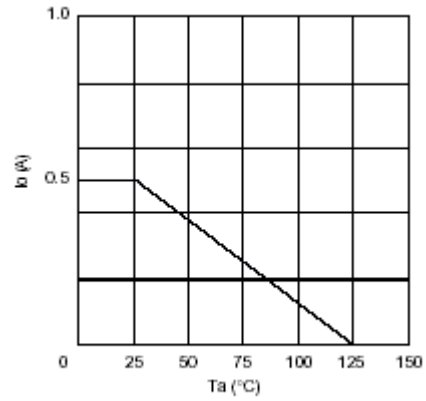

Fig.4 Derating curve



PACKAGE OUTLINE

Plastic surface mounted package; 2 leads

SOD-323

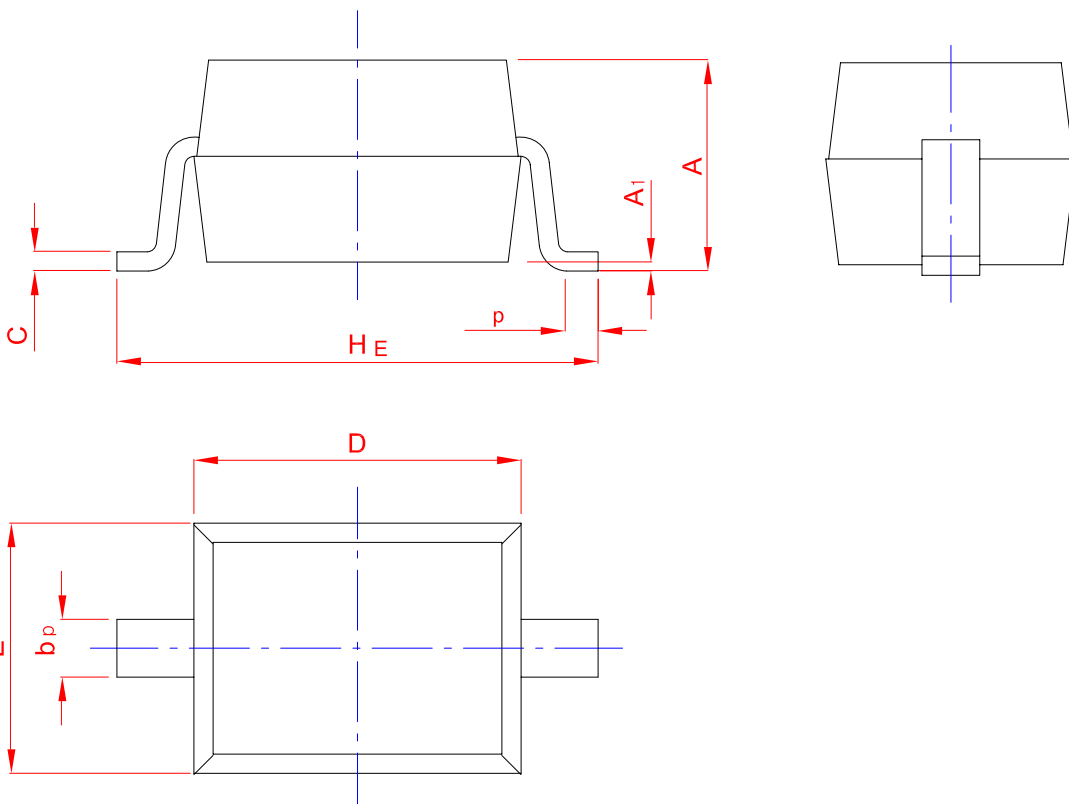
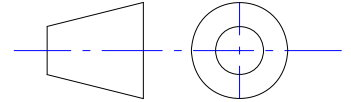

UNIT	A	b _p	C	D	E	H _E	A ₁	L _p
mm	1.20	0.40	0.15	1.80	1.35	2.80	0.10	0.50
	0.90	0.25	0.10	1.60	1.15	2.30	0.01	0.20

X-ON Electronics

Largest Supplier of Electrical and Electronic Components

Click to view similar products for [Schottky Diodes & Rectifiers](#) category:

Click to view products by [Hong Kong Chuangji](#) manufacturer:

Other Similar products are found below :

[MA4E2039](#) [MA4E2508M-1112](#) [MBR0530L-TP](#) [MBR10100CT-BP](#) [MBR1545CT](#) [MMBD301M3T5G](#) [RB160M-50TR](#)

[BAS16E6433HTMA1](#) [BAS 3010S-02LRH E6327](#) [BAT 54-02LRH E6327](#) [IDL02G65C5XUMA1](#) [NSR05F40QNXT5G](#) [NSVR05F40NXT5G](#)

[NTE555](#) [JANS1N6640](#) [SB07-03C-TB-H](#) [SK310-T](#) [SK33A-TP](#) [SK34B-TP](#) [SS3003CH-TL-E](#) [PDS3100Q-7](#) [GA01SHT18](#)

[CRS10I30A\(TE85L,QM](#) [MA4E2501L-1290](#) [MBRB30H30CT-1G](#) [JANTX1N5712-1](#) [SB007-03C-TB-E](#) [SK33B-TP](#) [SK35A-TP](#) [SK38B-LTP](#)

[NTE505](#) [NTSB30U100CT-1G](#) [VS-6CWQ10FNHM3](#) [CRG04\(T5L,TEMQ\)](#) [ACDBA1100LR-HF](#) [ACDBA1200-HF](#) [ACDBA240-HF](#)

[ACDBA3100-HF](#) [CDBQC0530L-HF](#) [ACDBA260LR-HF](#) [ACDBA1100-HF](#) [MA4E2502L-1246](#) [10BQ015-M3/5BT](#) [10BQ060-M3/5BT](#)

[NRVB130LSFT1G](#) [CRS08TE85LQM](#) [PMAD1108-LF](#) [B120Q-13-F](#) [1N5819T-G](#) [B0530WSQ-7-F](#)