

**RoHS**

# Specification

## 规格书

Customer Name:

客户名称: \_\_\_\_\_

Customer P/N:

客户品号: \_\_\_\_\_

Factory P/N:

公司品号: GT-3528U41FC-T30-2

Sending Date:

送样日期: \_\_\_\_\_

Client approval 客户审核			Goozo approval 鸿利国泽审核		
Approval 核准	Audit 确认	Confirmation 制作	Approval 核准	Audit 确认	Confirmation 制作
			潘桂建	钟亚程	夏昊
<input type="checkbox"/> Qualified 接受		<input type="checkbox"/> Disqualified 不接受	DATE: 日期:		



Address: Dangui Road NO. 1 Dantu Area Zhenjiang City Jiangsu Province

地址: 江苏省镇江市丹徒区丹桂路1号

Tel/电话: 020-37705135

Fax/传真: 020-37705136

Web/网址: www.goozo.com.

cn注:

- 1.此规格书以中英文方式书写,若有冲突以中文版本为准文本.
- 2.此规格书的最终解释权归属江苏鸿利国泽光电科技有限公司

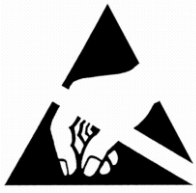

**ATTENTION 注意**  
 OBSERVE PRECAUTIONS  
 FOR HANDLING  
 ELECTROSTATIC  
 DISCHARGE  
 SENSITIVE  
 DEVICES

**Features**

- Compatible with automatic placement equipment
- Compatible with reflow solder process
- Low power consumption and wide viewing angle
- This product doesn't contain restriction substance, comply ROHS standard

**Applications**

- Automotive and Telecommunication
- General use for indicators
- Indoor display

**Package Dimensions**

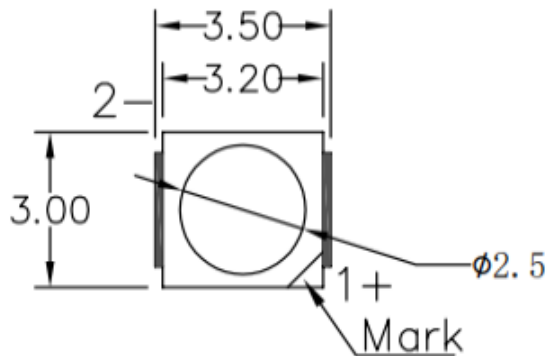

1: ANODE  
 2: CATHODE

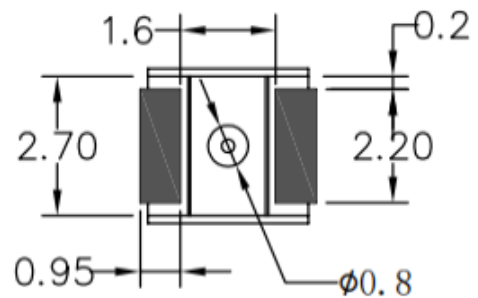
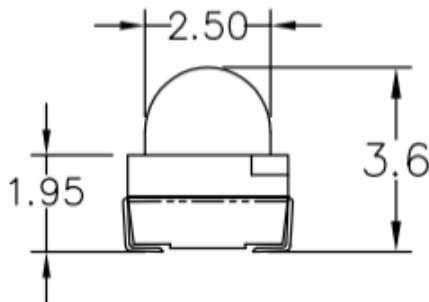

■ Recommended Soldering Patter

<Units:mm>

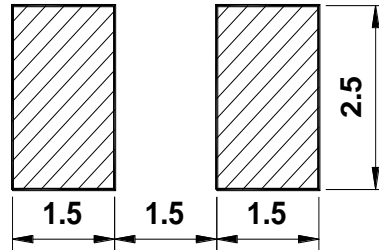

Tolerance Grade/公差等级	Dimension Tolerance/尺寸 (Unit:mm)			
	0.5~3	3~6	6~30	30~120
	±0.1	±0.2	±0.3	±0.5
Chip/晶片		Lens Color/胶体颜色		
Material/材质	Emitting Color/ 发光颜色		Water Clear/无色透明	
AlGaInP	Red/红色			

■ Absolute Maximum Rating

Item 项目	Symbol 符号	Value 数值	Unit 单位
Forward Current 正向电流	IF	20	mA
Peak Forward Current* 峰值正向电流	IFP	30	mA
Reverse Voltage 反向电压	VR	5	V
Power Dissipation 功耗	PD	45	mW
Electrostatic discharge 抗静电能力	ESD	2000	V
Operation Temperature 操作温度	Topr	-40~+85	°C
Storage Temperature 储存温度	Tstg	-40~+100	°C
Lead Soldering Temperature* 引脚焊接温度	Tsol	Max. 260°C for 5sec Max.	

\*IFP Conditions : Pulse Width≤10msec /IFP 正向峰值电流使用条件: 脉冲宽度≤10 毫秒

**■ Typical Optical/ Electrical Characteristics Ta=25°C**

Item/项目	Symbol/符号	Condition/条件	Rank/档次	Min. 最小值	Typ. 典型值	Max. 最大值	Unit 单位
Luminous Intensity/光强	IV	IF=20mA		3700	--	6300	mcd
Forward Voltage/正向电压	VF			1.8	--	2.4	V
Dominant Wavelength/主波长	$\lambda_d$			620	--	630	nm
Viewing Angle/角度	2 $\theta$ 1/2			--	30	--	deg
Recommend Forward Current/推荐使用正向电流	IF(rec)	--		--	--	20	mA
Reverse Current/反向电流	IR	Vr=5V		--	--	10	uA

**Notes/注释:**

 Tolerance : VF $\pm$ 0.1V,  $\lambda_d$  $\pm$ 2 nm, IV( $\phi$ )  $\pm$ 15%, 2 $\theta$  1/2 $\pm$ 15%, X/Y $\pm$ 0.005.

 公差: 正向电压 $\pm$ 0.1V, 主波长 $\pm$ 2 nm, 光强 (光通量)  $\pm$ 15%, 角度 $\pm$ 15%, X/Y $\pm$ 0.005.

**■ Ranks**
**Forward Voltage(IF=20mA)**

	Min	Max	Unit
BIN1	1.8	2.0	V
BIN2	2.0	2.2	V
BIN3	2.2	2.4	V

**Luminous Intensity(IF=20mA)**

	Min	Max	Unit
BIN1	3700	4900	mcd
BIN2	4900	6300	mcd

**Dominant Wavelength(IF=20mA)**

	Min	Max	Unit
BIN1	620	625	nm
BIN2	625	630	nm

■ Typical Electrical/ Optical Characteristics Curves

Ta=25°C

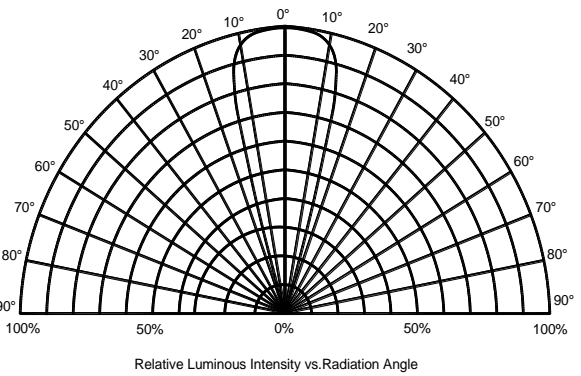
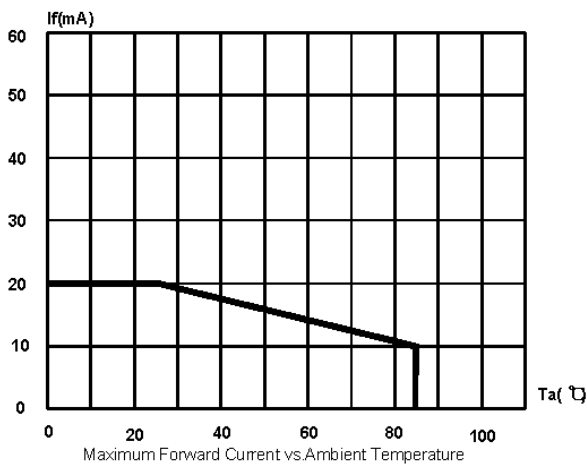
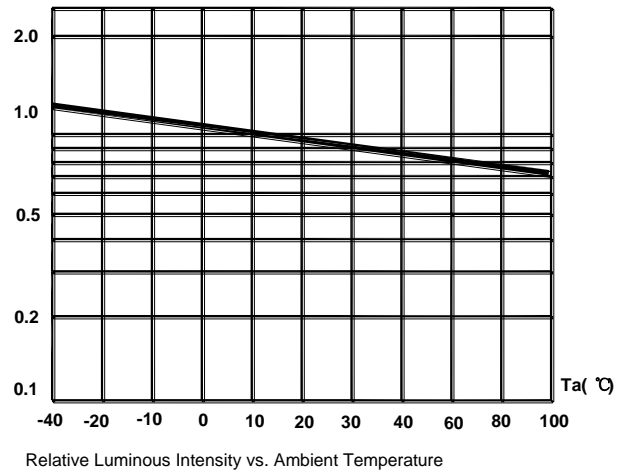
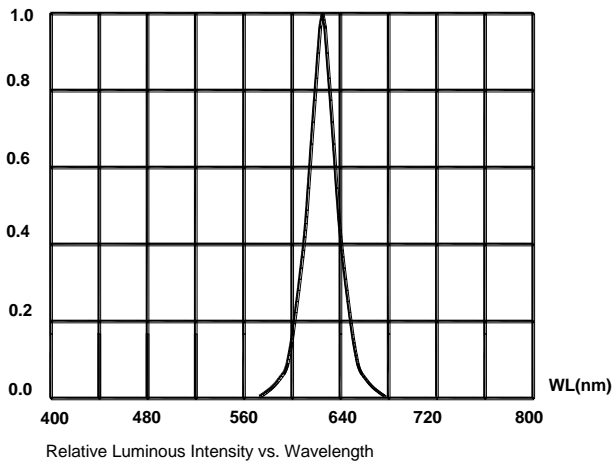
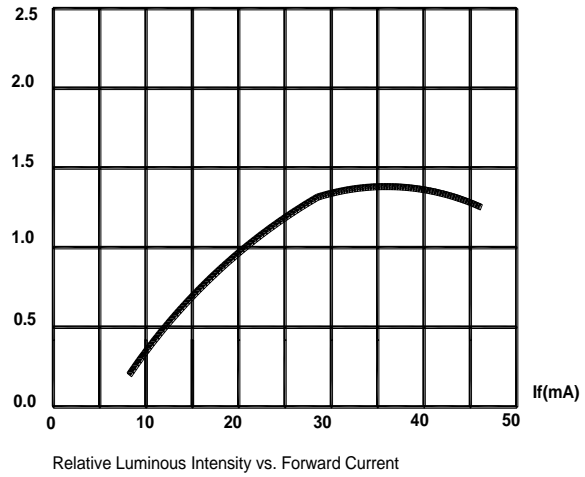
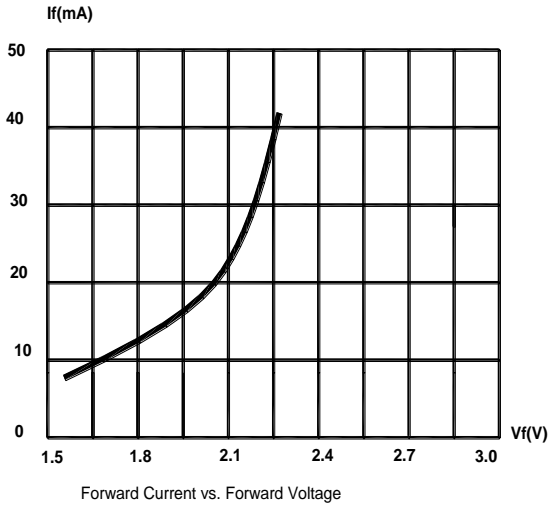

**■ Reliability Performance 可靠性**
**Test Items And Result 测试项目和判定**

Test Classification 测试类别	Test Item 测试项目	Test Conditions 测试条件	Test Duration 测试持续时间	Sample Size 样品数量	AC/RE 接受/拒收
Life Test 寿命测试	Room Temperature DC Operating Life Test 室温直流寿命测试	$T_a=25^{\circ}\text{C}\pm 5^{\circ}\text{C}$ , $I_f=20\text{mA}$	1000 hrs	22 pcs	0/1
Environment Test 环境模拟 实验	Thermal Shock Test 冷热冲击	$100^{\circ}\text{C}\pm 5^{\circ}\text{C}$ 5min ↑↓ $-40^{\circ}\text{C}\pm 5^{\circ}\text{C}$ 5min.	100 cycles	22 pcs	0/1
	Temperature Cycle Test 高低温循环实验	$100^{\circ}\text{C}\pm 5^{\circ}\text{C}$ 30min ↑↓5min $-40^{\circ}\text{C}\pm 5^{\circ}\text{C}$ 30min.	100 cycles	22 pcs	0/1
	High Temperature & High Humidity Test 高温高湿实验	$60^{\circ}\text{C}\pm 5^{\circ}\text{C}/90\% \text{RH}$ $I_f=20\text{mA}$	1000 hrs	22 pcs	0/1
	High Temperature Storage 高温储存	$T_a=100^{\circ}\text{C}\pm 5^{\circ}\text{C}$	1000 hrs	22 pcs	0/1
	Low Temperature Storage 低温储存	$T_a=-40^{\circ}\text{C}\pm 5^{\circ}\text{C}$	1000 hrs	22 pcs	0/1
Mechanica Test 机械测试	Resistance to Soldering Heat 耐焊接实验	Temp= $260^{\circ}\text{C}$ max T=5sec max	1 times	22 pcs	0/1

**■ Failure criteria**

Item	Symbol	Test Conditions	Criteria for judgment	
			Min	Max
Forward Voltage	VF	$I_f=20\text{mA}$	-	U.S.L*1.2
Reverse Current	IR	VR=5V	-	U.S.L*2.0
Luminous Intensity	IV	$I_f=20\text{mA}$	L.S.L*0.7	-

If the led is not dead and meets the above requirements, it is deemed qualified.

PS: U.S.L:Upper Standard Level L.S.L:Lower Standard Level

**SMT Reflow Soldering Instructions SMT 回流焊说明**

- 1.Reflow soldering should not be done more than two times. 回流焊不可以做两次以上
- 2.When soldering , do not put stress on the LEDs during heating  
 当焊接时，不要在材料受热时用力压胶体表面

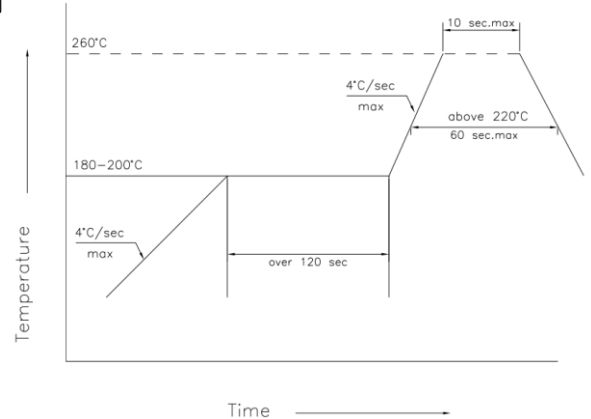

**Soldering iron 烙铁焊接**

- 1.When hand soldering, keep the temperature of iron below less 300°C less than 3 seconds  
 当手工焊接时，烙铁的温度必须小于 300°C，时间不可超过 3 秒
- 2.The hand solder should be done only one times  
 手工焊接只可焊接一次

**Repairing 修补**

Repair should not be done after the LEDs have been soldered. When repairing is unavoidable, a double-head soldering iron should be used (as below figure). It should be confirmed in advance whether the characteristics of LEDs will or will not be damaged by repairing.

LED 回流焊后不应该修复，当修复是不可避免时，必须使用双头烙铁（如下图），但必须事先确认此种方式会或不会损坏 LED 本身的特性。

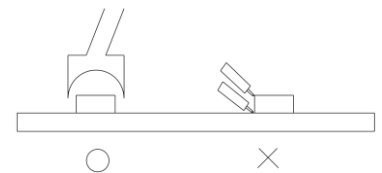

**Cautions 注意事项**

The encapsulated material of the LEDs is silicone. Therefore the LEDs have a soft surface on the top of package. The pressure to the top surface will be influence to the reliability of the LEDs. Precautions should be taken to avoid the strong pressure on the encapsulated part. So when use the picking up nozzle, the pressure on the silicone resin should be proper.

LED 封装为硅胶，故 LED 胶体表面较软，用力按压胶体表面会影响 LED 可靠性，因此应有预防措施避免在封装的零件上的强大压力，当使用吸嘴时，胶体表面的压力应是恰当的。

3. Do not stack together assembled PCBs containing LEDs. Impact may scratch the silicone lens or damage the internal circuitry  
 不可将模组材料堆积在一起，它可能会损坏内部电路

4. Not suitable to operate in acidic environment, PH<7  
 不可用在 PH<7 的酸性场所

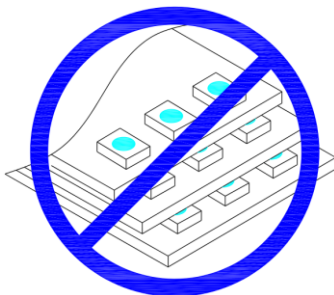

## X-ON Electronics

Largest Supplier of Electrical and Electronic Components

*Click to view similar products for [Standard LEDs - SMD category](#):*

*Click to view products by [HONGLITRONIC manufacturer](#):*

Other Similar products are found below :

[LTST-C190KYKT](#) [LTST-C19GD2WT](#) [LTST-N683GBEW](#) [LTW-170ZDC](#) [LTW-M140SZS40](#) [598-8110-100F](#) [598-8170-100F](#) [598-8610-202F](#) [91-21SURC/S530-A3/TR10](#) [AAAF5060QBFSEEZGS](#) [ALMD-LB36-SV002](#) [APT1608QGW](#) [EAST2012YA0](#) [EASV1803BA0](#) [91-21UYC/S530-A3/TR10](#) [LG M67K-H1J2-24-0-2-R18-Z](#) [SML-512VWT86A](#) [SML-LX0606SISUGC/A](#) [SML-LXL1307SRC-TR](#) [SML-LXR851SIUPGUBC](#) [LT1ED53A](#) [AM27ZGC03](#) [APB3025SGNC](#) [APFA3010SURKCGKQBDC](#) [APHK1608VGCA](#) [APT2012QGW](#) [CLX6D-FKB-CN1R1H1BB7D3D3](#) [LTST-008BGEW](#) [LTST-C250KGKT](#) [LTW-010DCG](#) [LTW-020ZDCG](#) [LTW-21TS5](#) [LTW-220DS5](#) [42-21UYC/S530-A3/TR8](#) [598-8330-117F](#) [SML-LX0402IC-TR](#) [CMDA20AYAA7D1S](#) [CMDA16AYDR7A1X](#) [91-21SYGD/S530-E2/TR7](#) [598-8040-100F](#) [598-8070-100F](#) [598-8140-100F](#) [598-8610-200F](#) [EAST2012GA0](#) [EAPL3527GA5](#) [SML-LXL1209SYC/ATR](#) [EAST2012RA0](#) [EAST1608RGBAO](#) [LTW-008RGB2-PH1](#) [CMD91-21VRC/TR7](#)