

RoHS

Specification

Client Name:

客户名称:

Client P/N: _____

客户品号:



Product P/N: _____

产品型号:

HL-C3535F3V3GA-ZW

Sending Date: _____

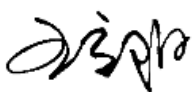
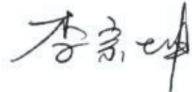
送样日期:

Client approval 客户审核		Hongli approval 鸿利智汇审核		
Approval 核准	Audit 确认	Audit 确认		Confirma- tion 制作
		Sales department 营销中心	Quality department 品质部	Engineering technol- ogy centre 工程技术中心
				 伍学海
<input type="checkbox"/> Qualified 接受 <input type="checkbox"/> Disqualified 不接受		DATE: 日期: 2021.10.21		

Adr: NO.1,Xianke Yi Road,Huadong Town.,Huadu District,Guangzhou,China

地址: 中国广州市花都区花东镇先科一路1号

Tel/电话: 020-86733333

Fax/传真: 020-86733883 86733938

86733265

注: 1. 此规格书以中英文方式书写,若有冲突以中文版本为准文本.

2. 此规格书的最终解释权归鸿利智汇集团股份有限公司

3. 此规格书的有效期限为两年,自盖章或签字之日起计算,期满时双方可以续签协议,但应采用书面形式



Catalog目录

1. Product naming rules	
产品命名规则	3
2. Features	
特点	3
3. Application range	
应用范围	4
4. Radiation Pattern	
辐射模式	4
5. Specifications	
规范	5-6
6. Product bins	
产品分级	7
7. Typical Optical/Electrical Characteristics Curves	
典型光学/电性特征曲线	8-9
8. Package Dimensions	
封装尺寸	9
9. Welded plate and steel mesh Dimensions	
焊盘及钢网尺寸	10
10. Label	
标签	11
11. Tape Specifications	
包装规格	12
12. Reflow soldering instructions	
回流焊说明	13
13. Use the matters needing attention	
使用注意事项	14-15

Product naming rules 产品命名规则

HL-C 3535 F3 V 3 G A - ZW
1 2 3 4 5 6 7 8 9

- 1: 鸿利代码
- 2: 产品系列代码
- 3: 尺寸代码
- 4: 芯片代码
- 5: 表示发光颜色为紫光
- 6: 表示使用700mA分光
- 7: 表示模具代码
- 8: 基板材质代码
- 9: 表示植物照明



ATTENTION
OBSERVE PRECAUTIONS
FOR HANDLING
ELECTROSTATIC
DISCHARGE
SENSITIVE
DEVICES

Features 特点

- Dimension 尺寸: 3.45mm*3.45mm*2.15mm
- Long operating life 寿命长
- High efficiency 高效率
- Lambertian radiation pattern 朗伯光照模式
- Low voltage DC operated 低电压直流工作
- High heat dissipation efficiency 散热效率高
- Cool beam, safe to the touch 冷光源, 触摸安全
- Superior ESD protection 良好的静电防护能力
- RoHS compliant 符合RoHS标准



Under Development	
Mass production	●

Application range 应用范围

- Small size, Flexible design 体积小, 设计灵活
- Decorative/Entertainment 装饰/娱乐
- Stage lighting 舞台照明
- Scene lighting 情景照明
- Landscape lighting 景观照明
- Bollards/Security/Garden/Architectural 光柱/安全/花园/建筑



Radiation Pattern 辐射模式

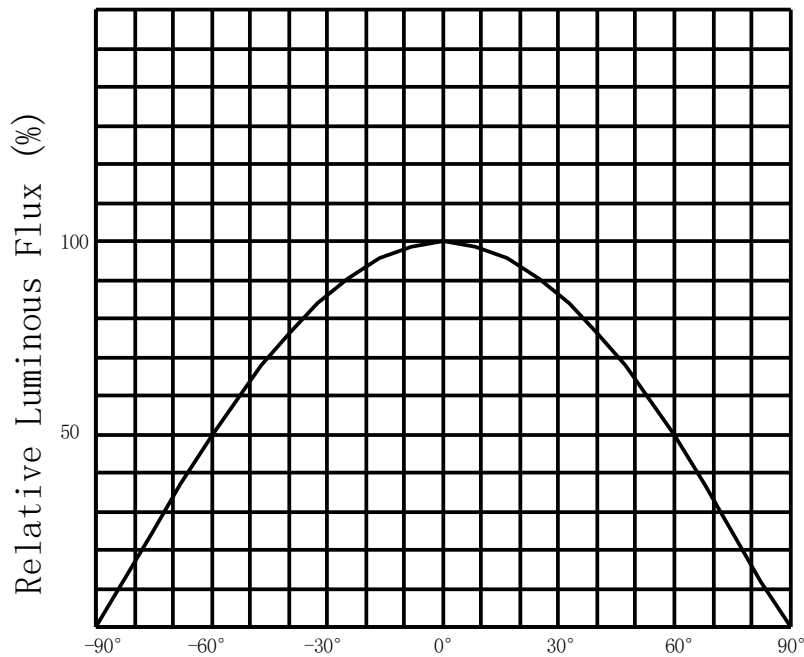
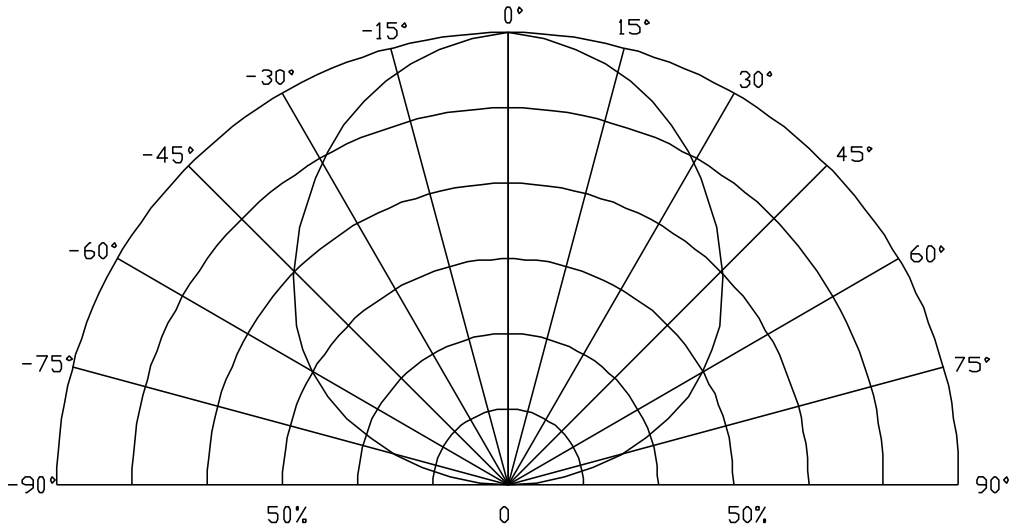

Specifications规范

(1) Absolute Maximum Ratings at Ta=25°C

在25°C时绝对极限条件

Parameter参数	Symbol符号	Rating 值	Units单位
Input power 输入功率	Pi	3	W
Peak Forward Current 正向电流	I _{FP}	800	mA
Reverse Current 反向漏电流	I _R	3@5V	uA
Junction Temperature 结温	Tj	115	°C
View Angle (FWHM) 发光角度	2θ _{1/2}	120~140	degrees
Operating Temperature Range 工作温度	Topr	-35°C To +100°C	
Storage Temperature Range 储藏温度	Tstg	-40°C To +100°C	
Reverse voltage 反向电压	Vr	not designed for reverse bias 不允许反向工作	

Notes注:

1.* All high power emitter LED products mounted on aluminum metal-core printed circuit board, can be lighted directly, but we do not recommend lighting the high power products for more than 5 seconds without a appropriate heat dissipation equipment. When using at 800mA, TS (cathode point) temperature should be controlled below 85°C .

所有高功率的发光LED产品安装在铝金属为核心印刷电路板，可直接点亮，但我们不建议在没有一个适当的散热设备时，照明高功率LED点亮超过5秒，当产品为800mA使用，TS点（负极焊盘）温度控制在85°C以下。

2.wave peak and soak-stannum soldering etc.is not suitable for this products.

波峰焊、浸锡焊接不适合这个产品。

3.Reflow soldering should not be done more than two times.The reflow temperature we recommend is 260°C,When the temperature exceeds 260 °C, the product failure of LED can be caused

回流焊不能超过两次,回流焊最高温度建议260°C，当温度超过260°C极大可能引起LED产品失效。

(2) Optical Characteristics at Ta=25°C

在Ta=25°C 时的典型光学特性

Symbol 符 号	Item名称	Min. 最低	Typ. 典型	Max. 最高	Units 单 位	Test Condi- tions 测试条件
Φ_e	Radiation Power 辐射功率	600	700	—	mW	IF=700mA
PPF	Photosynthetic Photon Flux [1] 光量子	0.2	0.25	—	$\mu\text{mol/s}$	IF=700mA
PPE	Photosynthetic Photon Flux Effi- ciency 光量子效率	0.07	0.1	—	$\mu\text{mol/J}$	IF=700mA
BPF	Plant Biologically-Active Photon Flux [2] 光量子	2.0	2.2	—	$\mu\text{mol/s}$	IF=700mA
BPE	Plant Biologically-Active Photon Flux Efficiency 光量子效率	0.75	0.85	—	$\mu\text{mol/J}$	IF=700mA
VF	Forward Voltage [3] 正向电压	3.2	—	3.8	V	IF=700mA
λ_p	Peak Wavelength 峰值波长	385	390	395	nm	IF=700mA
IR	Reverse Current 反向电流	—	—	3	μA	VR = 5V

Notes注:

1. Photosynthetic Photon Flux includes wavelengths between 400 and 700 nm
光合光子通量的测试范围是400-700nm。
2. Plant Biologically-Active Photon Flux includes wavelengths between 280 and 800 nm
植物感应光子通量的测试范围是280-800nm。
3. Tolerance of measurement of forward voltage $\pm 0.1\text{V}$ 、peak Wavelength $\pm 2.0\text{nm}$ 、Radiation Power $\pm 5\%$

(3) Optical Electrical / Thermal Characteristics at Ta=25°C

在Ta=25°C 时典型的电学/热学特性

IF (mA)	VF typ (V)	R (j-s) (°C/W)	Po (W)
700	3.65	7.202	2.555



Product bins 产品分级 @IF=700mA Ta=25°C

(1) Forward Voltage bins 电压分级

Min VF(V)	Max VF(V)
3.2	3.4
3.4	3.6
3.6	3.8

(2) Brightness bins 亮度分级

Min Φ_e (mW)	Max Φ_e (mW)
600	700
700	800

(3) Wavelength bins 波长分级

Min Wp(nm)	Max Wp(nm)
385	390
390	395



Typical Optical/Electrical Characteristics Curves($T_a=25^{\circ}\text{C}$ Unless Otherwise Noted)

典型光学/电性特征曲线 ($T_a=25^{\circ}\text{C}$ 除非另有注释)

电流-正向电压曲线

IF - VF

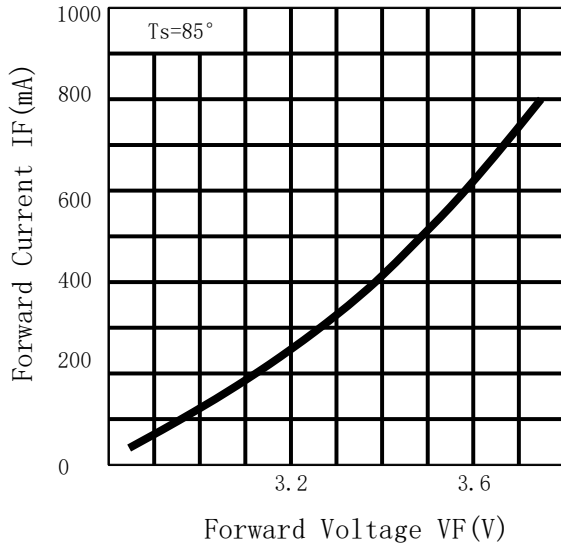

电流-相对光通量曲线

Relative Luminous Flux - IF

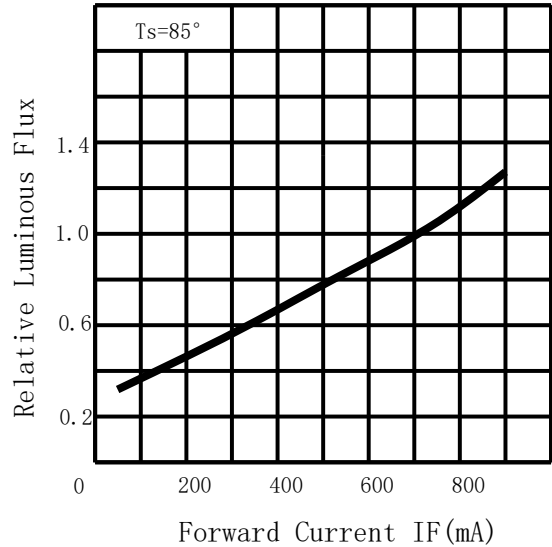

电流-波长漂移曲线

$\Delta \lambda_p$ - IF

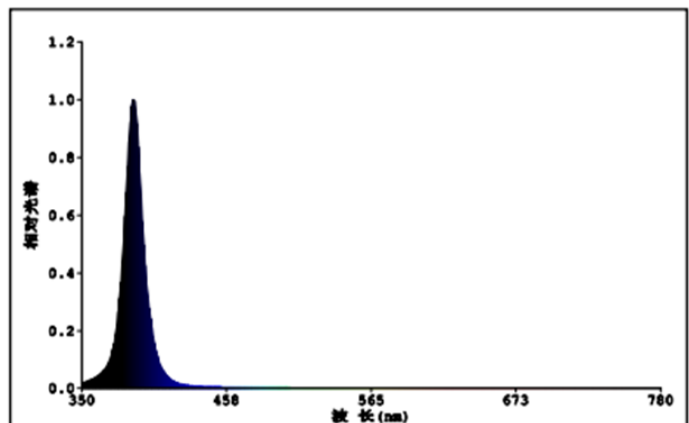
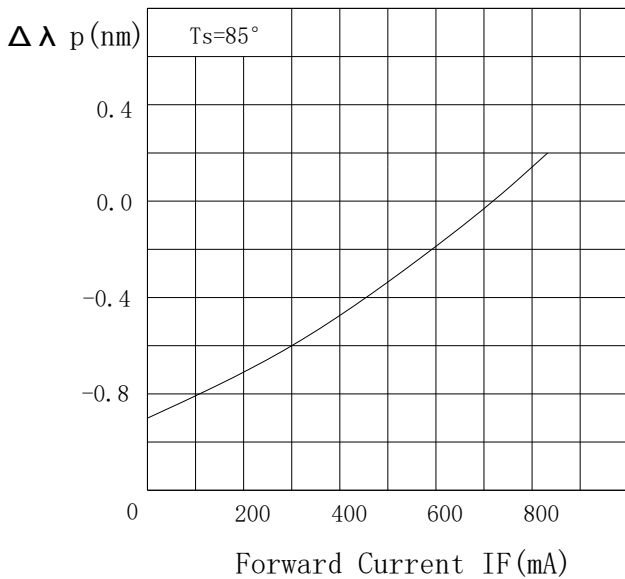



Typical Optical/Electrical Characteristics Curves 典型光学/电性特征曲线

温度-正向电压曲线

Ts - VF

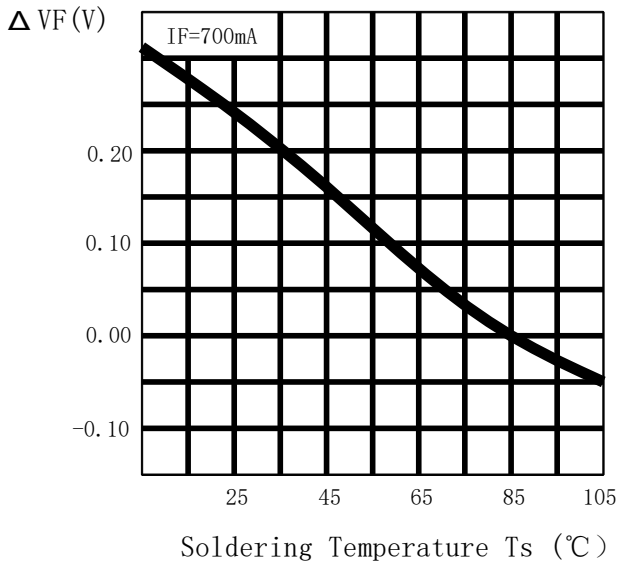

温度-相对光通量曲线

Relative Luminous Flux - Ts

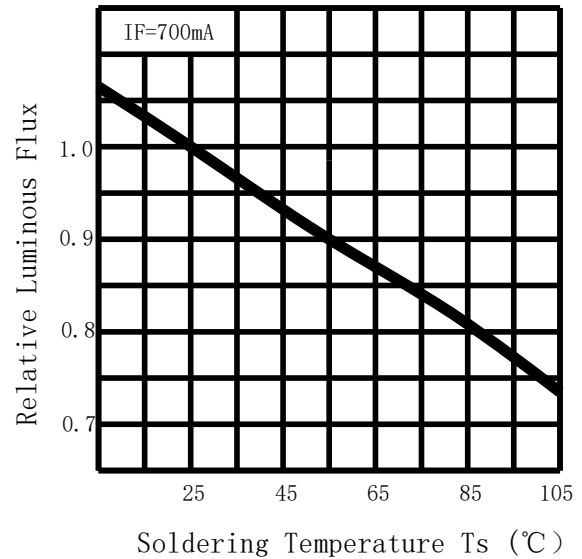

温度-波长漂移曲线

Δλp - Ts

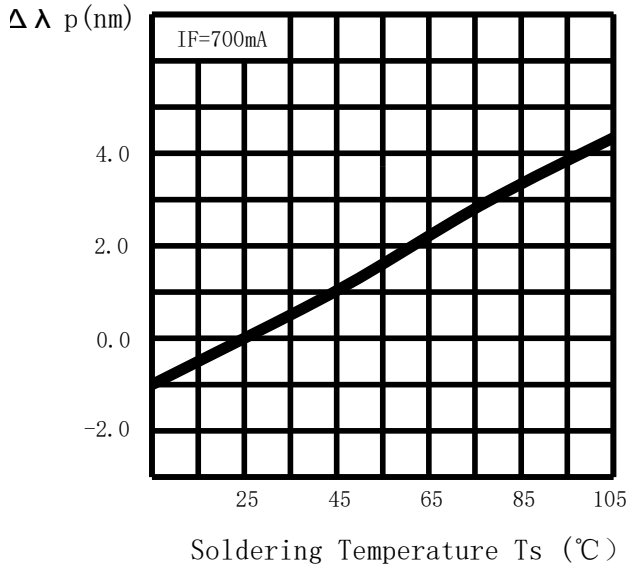

温度-最大允许操作电流

Allowable Forward Current - Ts

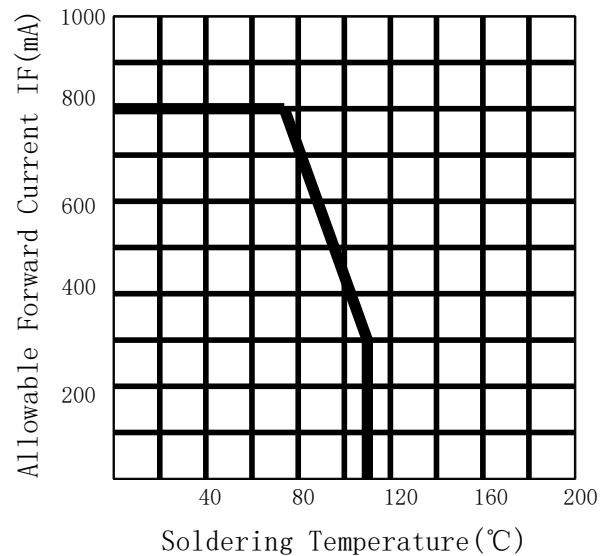



Package Dimensions 封装尺寸

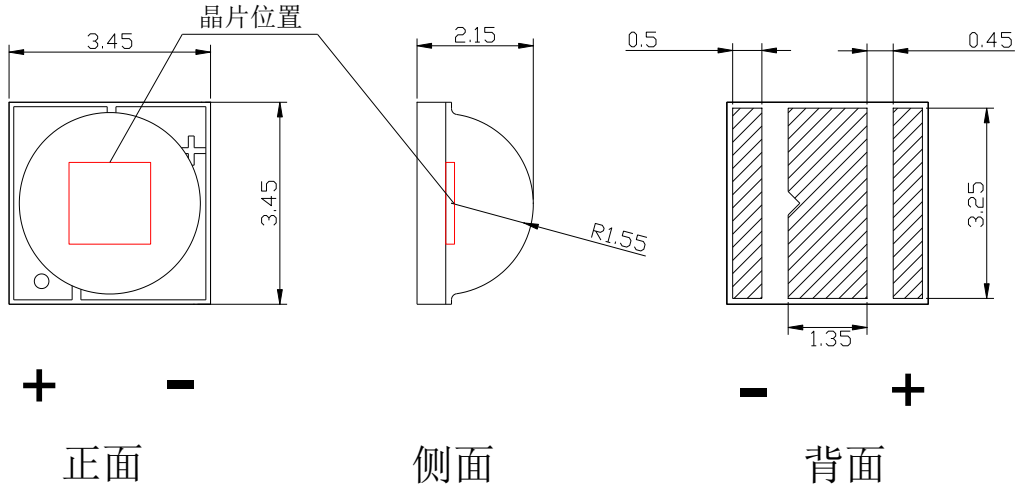

Notes 注:

- All dimension units are millimeters.
所有尺寸单位均为毫米.
- All dimension tolerance is ± 0.15 mm unless otherwise noted.
所有尺寸误差是 ± 0.15 毫米除非另有说明

Welded plate and steel mesh Dimensions 焊盘及钢网尺寸

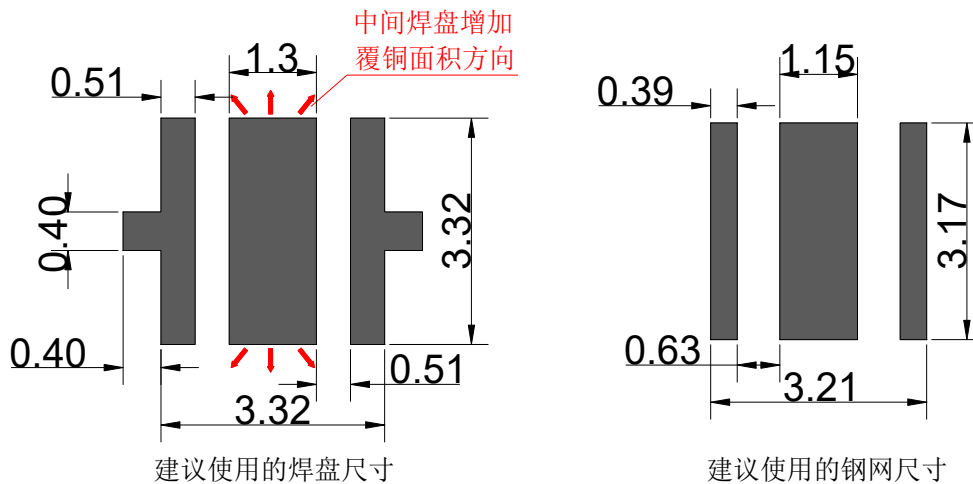

Notes 注:

When the circuit configuration is not affected, suggested the increase in the middle of the copper area, or the connection between the middle and the pad and the negative electrode can improve the cooling performance of the product.

在不影响电路配置时，建议增加中间焊盘覆铜区域，或中间焊盘和负极焊盘连接，能提高产品散热性能。

Label 标签

TYPE: XXXXXXXXXX

产品型号

QTY: XXXXX

包装数量

VF: Forward voltage rank

正向电压档次范围

ΦV: Luminous Flux rank

光通量档次范围

IF: XXXX

分选电流

WP: Peak Wave Length

峰值波长

DATE: XXXX

生产日期

LOT.NO: Lot Number

生产批号

	HONGLITRONIC 鸿利光电	
TYPE:XXXXXXXXXXXX	QTY:XXX PCS	
Bin:		
ΦV:	WP:	VF:
DATE:	LOT. NO:	

Tape Specifications(Units:mm)包装规格

(1)Reel package (1000 pcs/reel) 卷轴包装 (1000 pcs/卷)

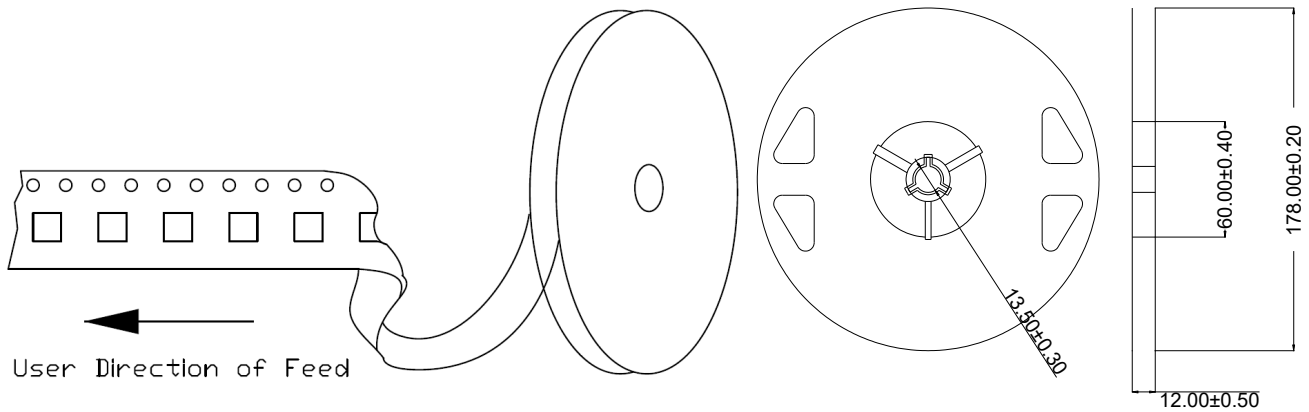
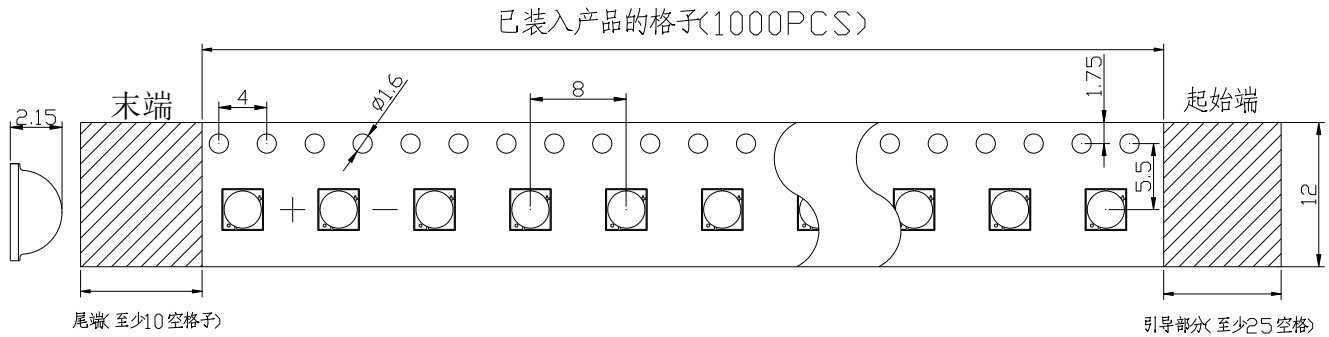

(2)Moisture resistant packaging 防潮包装

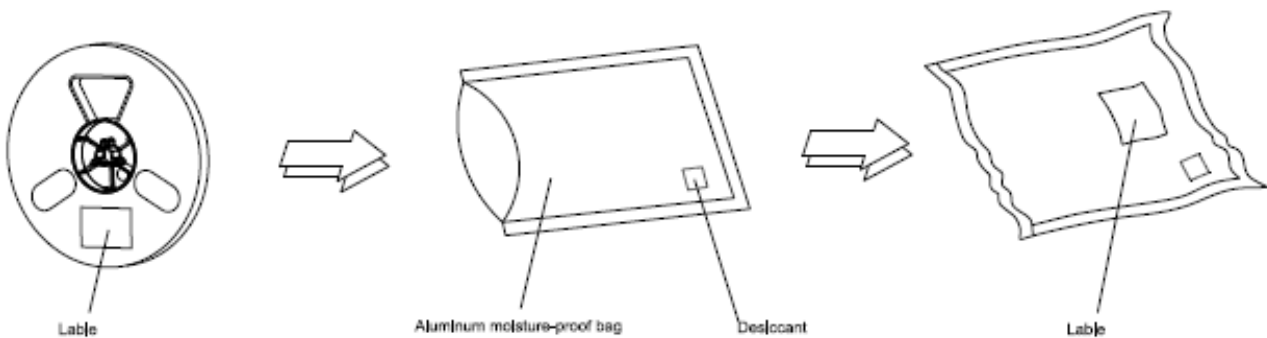



Soldering 焊接:

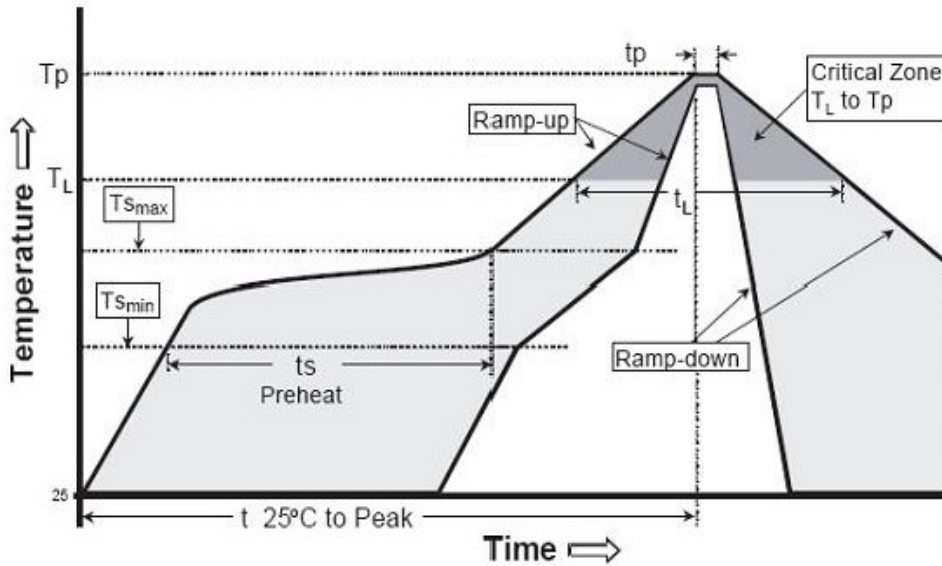

Reflow soldering 回流焊

Caution 注意:

1. wave peak and soak-stannum soldering etc. is not suitable for this products.
波峰焊、浸锡焊接不适合这个产品
2. reflow soldering should not be done more than one time
此产品只能过一次回流焊
3. The peak reflow temperature is $260 \pm 10^\circ\text{C}$, not more than 40 seconds
回流焊峰值温度为 $260 \pm 10^\circ\text{C}$, 不能超过40秒
4. Repairing should not be done after the LEDs have been soldered. When repairing is unavoidable, suitable tools have to be used.
焊接后, 尽量不要对LED进行修复, 如要修复, 请使用正确的工具.
5. when soldering, do not put stress on the LEDs during heating.
焊接时, 不要挤压灯头.
6. After soldering, do not warp the LED. do not stack PCBs or assemblies containing K Series LEDs so that anything rests on the LED lens.
焊接后, 不要将LED进行堆压, 不要将焊好LED的PCB板直接堆积, 以免使灯头被挤压.

Test 测试

1. Drive IFP Conditions: Pulse Width $\leq 10\text{msec}$ duty $\leq 1/10$.

驱动IFP的条件: 脉冲宽度 $\leq 10\text{ms}$ 占空比 $\leq 1/10$.

2. All high power emitter LED products mounted on aluminum metal-core printed circuit board, can be lighted directly, but we do not recommend lighting the high power products for more than 5 seconds without an appropriate heat dissipation equipment.

所有高功率的发光LED产品安装在铝基板上, 可直接点亮, 但我们不建议在没有一个适当的散热设备时, 照明高功率LED点亮超过5秒.

Use the matters needing attention(使用注意事项)

一、储存(storage):

为避免受潮的影响，我司建议产品在未开包装前储存条件为 5-30°C，相对湿度小于 60%；已开包装的 LED 光源请在 24H 内使用安装完毕，如未用完之产品，请进行除湿并抽真空后密封保存。开封超过一周或湿度卡发生变化时，请务必进行除湿，除湿条件：60°C±5°C，12H；

产品密封保存有效使用期为一年。

To avoid moisture, we recommend storage conditions for the unopened LED +5 ~ +30 °C, relative humidity <60%. LED should be used within 24 Hrs. of opening the package. Please make sure to dehumidify and vacuum pack the remaining/ unused LED. Dehumidifying condition: +60 ° C ± 5 ° C, 12 Hrs. Effective age for the sealed led is one year.

二、组装注意事项(the assembly notes):

焊接条件：此产品必须使用回流焊接的作业方式，回流曲线最高温度不可超过 260°C。作业或存放过程中不可有 1000g 以上的外力或尖锐物体作用于透镜表面（如压力，摩擦等外力以及钳子镊子等工具），以免造成元件损伤；

如果超出此使用条件，鸿利光电将不能保证产品的稳定性，如需使用超出的操作条件，请务必进行风险评估。

Soldering Conditions: This product must be used reflow soldering practices, the maximum temperature of reflow should not exceed 260°C . Please make sure when soldering, there is no external force on the soldering surface (such as pressure, friction or sharp metal nails, etc.), to avoid gold wire deformation or damage and other abnormalities.

If beyond recommended conditions, we cannot guarantee the LED stability, please do the risk assessment first.

三、防静电措施(anti-Static Measures):

请采取足够的措施来防止静电产生，比如带静电环或防静电手指套等；每个制造工程关于产品（工厂、设备、机器、载波机和运输单位）应当连接地面，避免产品电气带电。

Please take adequate measures to prevent electrostatic generation, such as wearing electrostatic ring or anti-static fingerstall etc; any relative products like plant equipment, machinery, carrier and transportation units shall be connected to discharging unit/ ground. After assembly, please make sure to discharge Static Electricity with proper ESD equipment.

四、温度控制(temperature Control):

保证散热前提条件为：TS点（负极焊盘）为75/85摄氏度以下，在此温度以下，散热符合产品寿命要求；为确保在组装时降低接触热阻，请注意在组装过程中，散热片采用良好品质的导热膏涂布均匀且分布面积合理，不可出现太少或高低不平等现象。散热介质需保证电介质耐压测试至少通过500V。

Recommended temperature conditions for enhanced product life: TS (Cathode Point) is $<75/85^{\circ}\text{C}$. During assembly, please ensure that a good quality thermal paste is applied and distributed evenly over the surface. While using thermal pad (Heat Sink), make sure LED is firmly tightened and there is no gap between surfaces. The need to ensure the cooling medium dielectric withstand test at least through 500V.

五、驱动控制(drive control):

本产品需使用恒流源进行驱动，且输出电流符合规格书上的功率使用范围，如需使用恒压源或其他使用条件，请进行使用效果风险评估。

Drive this product at constant current. Output current range specifications should be according to the operational and other conditions, as mentioned in data sheet. Before using a constant voltage source or altered specifications, other than recommended, please consider risk factors.

六、其他(other):

本产品不可在以下条件下使用，如果产品在以下条件下使用，评估其使用效果和风险是有必要的：

- 直接或间接的打湿或受潮，比如淋雨等；
- 被海水损害或侵蚀；
- 被暴露于腐蚀性气体(如 Cl_2 , H_2S 、 NH_3 、 SO_x 、 NO_x 等) ；
- 被暴露于粉尘、液体或油；
- 符合使用手册情况下，产品质保期为24个月，有保质协议的则以保质协议为准；
- 产品生命周期后进行回收处理。

Product is not suitable to use in following conditions;

- Direct or indirect wet / damp conditions, such as rain, etc;
- in contact with sea water and erosive materials;
- Exposed to corrosive gases (e.g., Cl_2 , H_2S , NH_3 , SO_x , NO_x , etc.);
- Exposed to dust, liquids or oils;
- In accordance with the user manual, the product shelf lift is 24 months, If there is a warranty agreement, the warranty agreement shall prevail;
- After the product life cycle for recycling.

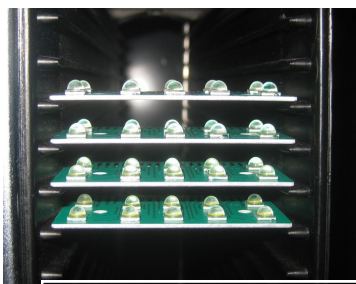

OK

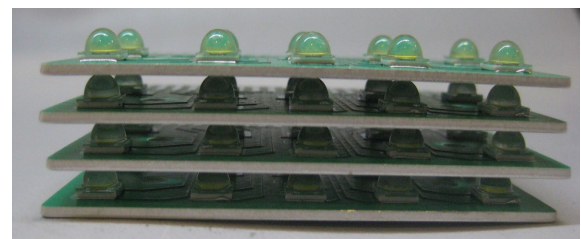

NG

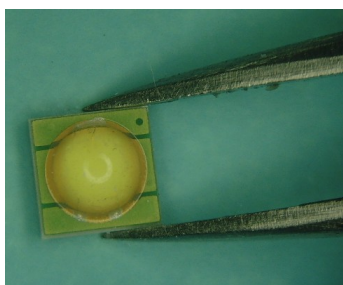

OK

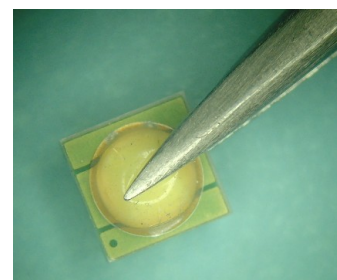

NG

修订次数	修订人	修订内容	修订日期	版次
1	梁依雯	新建文件	2021. 07. 05	A/0
2	伍学海	更新产品公差范围	2021. 10. 21	A/1
3				
4				
5				
6				
7				
8				
9				
10				
11				
12				
13				
14				
15				
16				
17				
18				
19				
20				
21				
22				
23				
24				
25				
26				

X-ON Electronics

Largest Supplier of Electrical and Electronic Components

Click to view similar products for [Standard LEDs - SMD category](#):

Click to view products by [HONGLITRONIC manufacturer](#):

Other Similar products are found below :

[LTST-C190KYKT](#) [LTST-C19GD2WT](#) [LTW-170ZDC](#) [LTW-M140SZS40](#) [LTW-M140ZVS](#) [598-8110-100F](#) [598-8610-202F](#) [91-21SUBCS400-A6TR7](#) [AAAF5060QBFSEEZGS](#) [HLMA-QG00-S0021](#) [HLMP-6305-L0011](#) [APT1608QGW](#) [99-213/R6C-AR2T1B/2C](#) [SML-LX0606SISUGC/A](#) [SML-LXR851SIUPGUBC](#) [LT1ED53A](#) [APFA3010SURKCGKQBDC](#) [APHK1608VGCA](#) [APT2012QGW](#) [LTST-008BGEW](#) [LTW-010DCG](#) [LTW-020ZDCG](#) [LTW-21TS5](#) [LTW-220DS5](#) [LO T67F-V1AB-24-1](#) [598-8330-117F](#) [65-21SYGC/S530-E3/TR8](#) [CMDA20AYAA7D1S](#) [95-21SURCS530-A3TR10](#) [HSMQ-C177](#) [598-8040-100F](#) [598-8070-100F](#) [598-8140-100F](#) [598-8610-200F](#) [EAPL3527GA5](#) [SML-LXR851SGSIC-TR](#) [SML-512PWT86A](#) [SMF-2432GYC-TR](#) [EASV3015RGYA0](#) [95-21UYC-S530-A5-TR7](#) [LTST-C190KFKT-5A](#) [LTST-C194TBKT-5A](#) [CLX6E-FKC-CH1M1D1BB7C3D3](#) [SML-LXL0805USBC-TR](#) [SML-LX2835SYSUGCTR](#) [LTW-M670ZVS-M5](#) [APA2106ZGC/G](#) [CLMXB-FKA-CbcfghjnpACBB79463](#) [VFA1101W-5AY3B2-TR](#) [LCB P473-P2R2-3J7L-1-Z](#)