

RoHS

Specification

规格书

Customer Name:

客户名称: _____

Customer P/N:



客户品号: _____

Factory P/N:

公司品号: **HL-PSC-1608S250C-G4**

Sending Date:

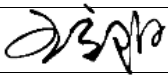
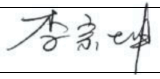
送样日期: _____

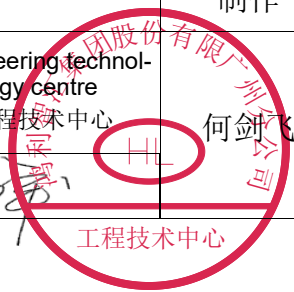
Client approval 客户审核		Hongli approval 鸿利智汇审核		
Approval 核准	Audit 确认	Audit 确认		Confirma- tion 制作
		Sales department 营销中心	Quality department 品质部	Engineering technol- ogy centre 工程技术中心
				 
<input type="checkbox"/> Qualified 接受 <input type="checkbox"/> Disqualified 不接受		DATE: 日期:		

Adr: No.1, Xianke Yi Road, Huadong Town, Huadu District, Guangzhou, China

地址: 中国广州市花都区花东镇先科一路1号

Tel/电话: 020-86733333
86733265

Fax/传真: 020-86733883 86733938

注: 1. 此规格书以中英文方式书写, 若有冲突以中文版本为准.

2. 此规格书的最终解释权归鸿利智汇集团股份有限公司

3. 此规格书的有效期限为两年, 自盖章或签字之日起计算, 期满时双方可以续签协议, 但应采用书面形式

HL-PSC-1608S250C-G4

Features (特征)

- Extremely wide viewing angle. (宽的发光角度)
- Suitable for all SMT assembly and solder process. (适用于所有的SMT组装和焊接工艺)
- Available on tape and reel. (适用于载带及卷轴)
- Moisture sensitivity level: Level 3. (防潮等级 Level 3)
- Package:4000pcs/reel.(包装每卷4000PCS)
- RoHS compliant. (RoHS 认证)

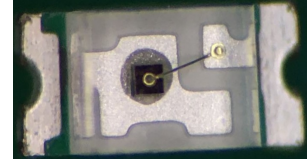

Description (描述)

The Amber source color devices are made with AlGaInP on Substrate Light Emitting Diode

橙色LED由AlGaInP四种元素芯片激发而成

After the product life cycle for recycling

产品生命周期后进行回收处理



ATTENTION
OBSERVE PRECAUTIONS
FOR HANDLING
ELECTROSTATIC
DISCHARGE
SENSITIVE
DEVICES

注意：操作时应注意静电敏感
释放设备装置

Applications (应用)

- Optical indicator (光学指示)
- Indoor display (室内显示)
- Backlight for LCD, switch and Symbol, display
(LCD背光、转换器, 开关和标志, 显示器等)
- General use (一般应用)

Package Dimensions (封装尺寸)

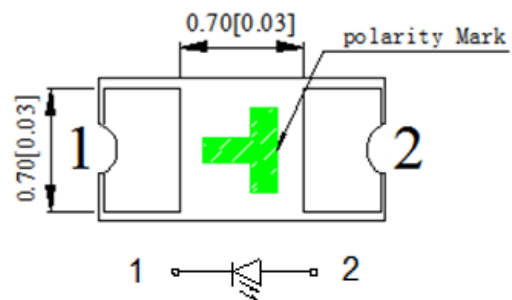
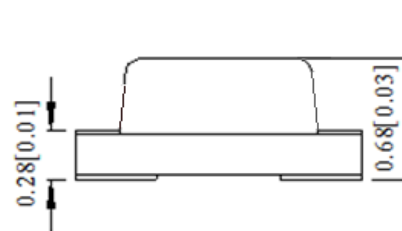
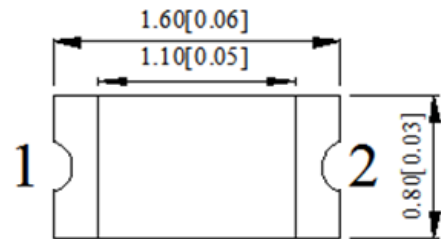

Recommended Soldering Pattern

(建议焊盘尺寸图)

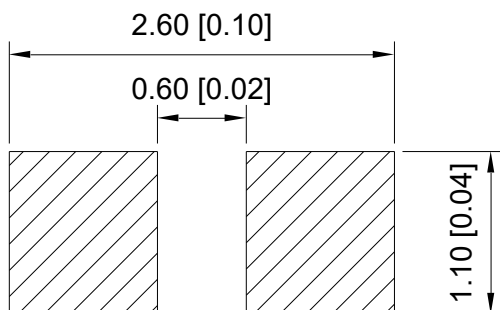

Notes: (备注)

1. Mark the size of the unit is mm.marked in brackets (标注尺寸单位为毫米, 括号内标注为英寸)
2. All dimensions allow tolerance $\pm 0.1\text{mm}$ (所有尺寸允许公差 $\pm 0.1\text{mm}$)

HL-PSC-1608S250C-G4

Selection Guide (选择指南)

Part No. 型号	Dice	Lens Type 胶体类型	Luminous Intensity (mcd) 光强@ 10mA		Viewing Angle 角度
			Min	Typ	2θ1/2
HL-PSC-1608S230C-G4	AlGaInP	Water Clear	70	90	130°

Note:(备注)

1. The 2θ1/2 measurement error ± 10 degrees(角度测试误差为±10°)
2. the above luminous intensity measurement allowance tolerance ±10%.
上述发光强度的测试允许公差为±10%

Electrical / Optical Characteristics at Ta=25°C 电性与光学特性

Parameter (参数)	Symbol (符号)	Min. (最小)	Typ. (平均)	Max. (最大)	Units (单位)	Test Conditions 测试条件
Forward Voltage 正向电压	V _F	1.8	--	2.4	V	I _F =10mA
Reverse Current 反向电流	I _R	--	--	10	μA	V _R = 5V
Dominate Wavelength 主波长	λ _d	600	--	612	nm	I _F =10mA

Absolute Maximum Ratings at Ta=25°C 绝对最大额定值

Parameter (参数)	Symbol (符号)	Rating (值)	Units (单位)
Power Dissipation (功耗)	P _d	60	mW
Forward Current (正向电流)	I _F	25	mA
Peak Forward Current [1] (峰值正向电流)	I _{FP}	100	mA
Reverse Voltage (反向电压)	V _R	5	V
Electrostatic Discharge (HBM) (静电)	ESD	2000	V
Operating Temperature (操作温度)	Topr	-40 ~ +85	°C
Storage Temperature (保存温度)	Tstg	-40 ~ +100	°C

Note: (备注)

1. 1/10 Duty cycle, 0.1ms pulse width. (脉宽0.1ms, 周期1/10)
2. The above forward voltage measurement allowance tolerance is ±0.1V. (以上所示电压测量误差±0.1V)
3. The above dominate wavelength measurement allowance tolerance is ±1nm. (以上所示波长测量误差±1nm)

HL-PSC-1608S250C-G4

Bin Range of Luminous Intensity (亮度分档)

Luminous Intensity (mcd) 亮度	
Code 代码	Range 范围
F	70-90
G	90-120

Bin Range of Forward Voltage (电压分档)

Forward Voltage (V) 电压			
Code 代码	Range 范围	Code 代码	Range 范围
K	1.8-1.9	N	2.1-2.2
L	1.9-2.0	O	2.2-2.3
M	2.0-2.1	P	2.3-2.4

Bin Range of Dominate Wavelength (主波长分档)

Dominate Wavelength (nm) 主波长			
Code 代码	Range 范围	Code 代码	Range 范围
A	600-603	D	609-612
B	603-606		
C	606-609		

HL-PSC-1608S250C-G4

Typical optical characteristics curves 典型光学特性曲线

Ambient Temperature vs. Forward Current

环境温度与正向电流特性曲线

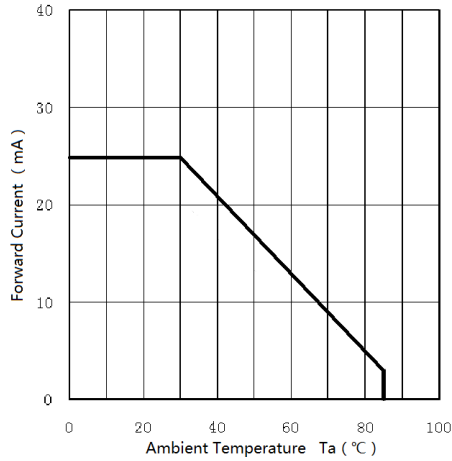

Forward Current VS. Relative Intensity

正向电流与相对光强特性曲线

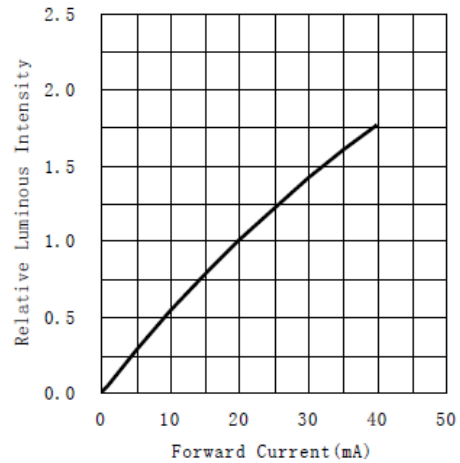

Forward Voltage VS. Forward Current

正向电压与正向电流特性曲线

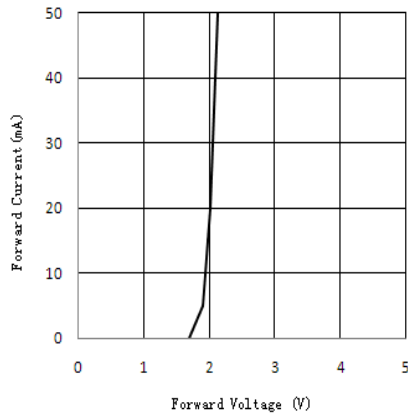

Ambient Temperature VS. Relative Intensity

环境温度与相对光强特性曲线

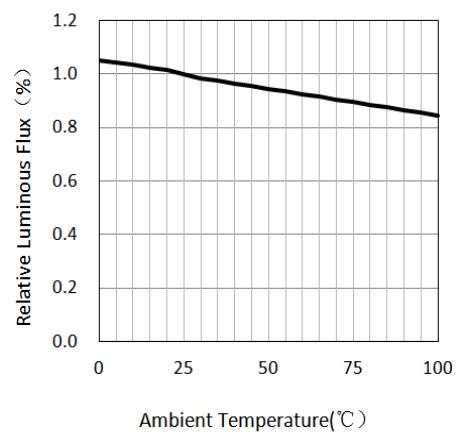

Relative spectral emission

相对光谱分布特性曲线

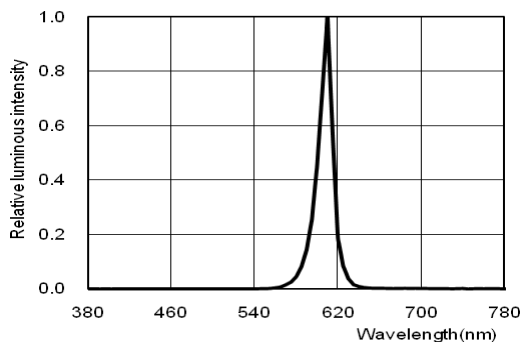

Radiation diagram

辐射图特性曲线

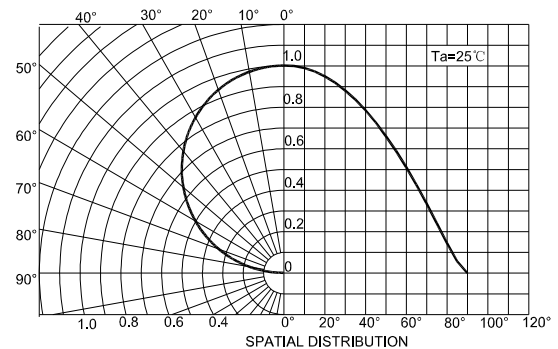

HL-PSC-1608S250C-G4

Reliability Test Items And Conditions 信赖性测试项目及条件

Test Items 项目	Ref.Standard 参考标准	Test Condition 测试条件	Time 时间	Quantity 数量	Ac/Re 接收/拒收
Reflow 回流焊	JESD22-B106	Temp:260°C max T=10 sec	3 times.	22Pcs.	0/1
Thermal Shock 冷热冲击	JESD22-A106	-45-125°C 15min/10s/15min	100 Cycles	22Pcs.	0/1
High Temperature Storage 高温保存	JESD22-A103	Temp:100°C±5°C	1000Hrs.	11Pcs.	0/1
Low Temperature Storage 低温保存	JESD22-A119	Temp:-40°C±5°C	1000Hrs.	11Pcs.	0/1
Life Test 常温通电	JESD22-A108	Ta=25°C±5°C IF=10mA	1000Hrs.	11Pcs.	0/1
High Temperature High Humidity 高温高湿保存	JESD22-A101	85°C±5°C/ 85%RH	1000Hrs.	11Pcs.	0/1

Criteria For Judging Damage 失效判定标准

Test Items 项目	Symbol 符号	Test Condition 测试条件	Criteria For Judgement 判定标准	
			Min. 最小	Max. 最大
Forward Voltage 正向电压	Vf	If=10mA	--	U.S.L*)x1.1
Reverse Current 反向电流	Ir	Vr = 5V	--	10uA
Luminous intensity 光强	Iv	If=10mA	L.S.L*)x0.7	--

U. S. L: Upper standard level 规格上限

L. S. L: Lower standard level

*The technical information shown in the data sheets are limited to the typical characteristics and circuit examples of the referenced products. It does not constitute the warranting of industrial property nor the granting of any license.

数据工作表中所示的技术信息仅限于典型特征和电路实例引用的产品。它既不构成工业特性的保证，也不构成任何许可的授权

HL-PSC-1608S250C-G4

SMT Reflow Soldering Instructions SMT回流焊说明

- 1.Reflow soldering should not be done more than three times. 回流焊不可以做三次以上
- 2.When soldering , do not put stress on the LEDs during heating
当焊接时，不要在材料受热时用力压胶体表面

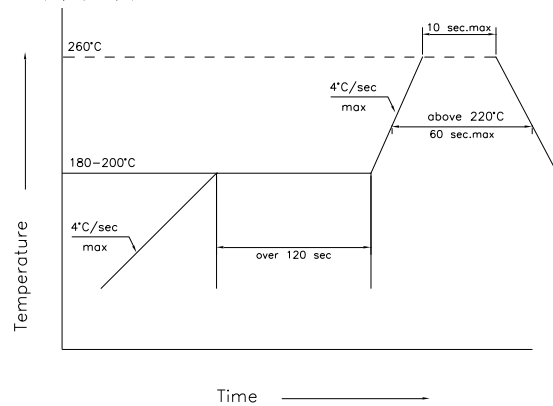

Soldering iron 烙铁焊接

- 1.When hand soldering, keep the temperature of iron below less 350°C less than 5 seconds
当手工焊接时，烙铁的温度必须小于350°C，时间不可超过5秒
- 2.The hand solder should be done only one times
手工焊接只可焊接一次

Repairing 修补

Repair should not be done after the LEDs have been soldered. When repairing is unavoidable, a double-head soldering iron should be used (as below figure). It should be confirmed in advance whether the characteristics of LEDs will or will not be damaged by repairing.

LED回流焊后不应该修复，当修复是不可避免时，必须使用双头烙铁（如下图），但必须事先确认此种方式会或不会损坏LED本身的特性。

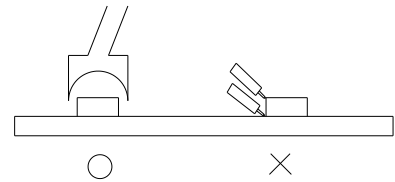

Cautions 注意事项

- 1.Do not stack together assembled PCBs containing LEDs. Impact may scratch the silicone lens or damage the internal circuitry
不可将模组材料堆积在一起，它可能会损坏内部电路

- 2.Not suitable to operate in acidic environment, PH<7
不可用在PH<7的酸性场所

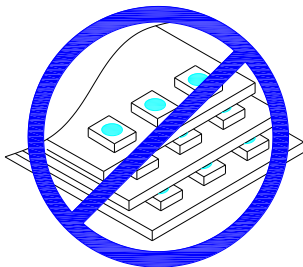

- 3.Other points for attention, please refer to our LED user manual, In accordance with the user manual, the product shelf life is 24 months, If there is a warranty agreement, the warranty agreement shall prevail

其它注意事项请参照我们的LED使用手册，符合使用手册的情况下，产品保质期为24个月，已签订保质协议的则以保质协议为准

HL-PSC-1608S250C-G4

Label 标签

Part No: Part number 型号
 Iv: Luminous intensity rank 亮度等级
 Wld: Dominate Wavelength 波长等级
 Vf: Forward voltage rank 电压等级
 Lot No: Lot number
 批号



Tape Specifications (Units : mm)

载带规格 (单位: mm)

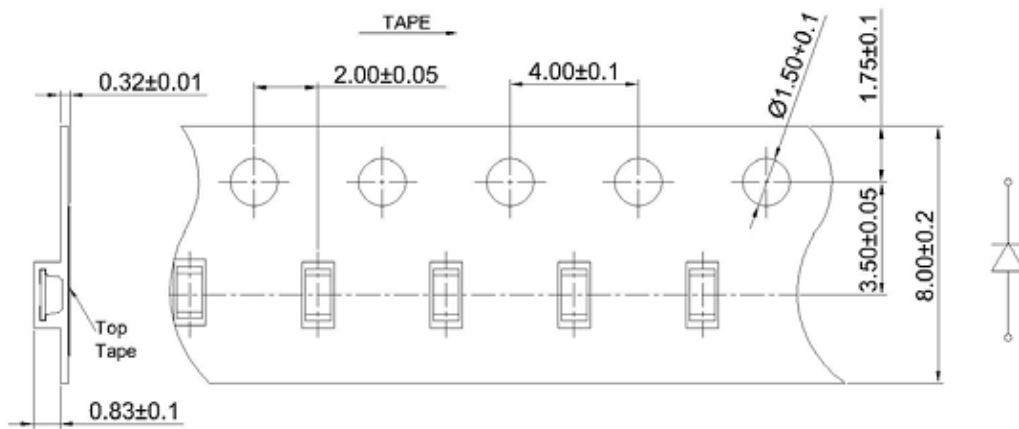

Reel Dimensions

卷轴尺寸

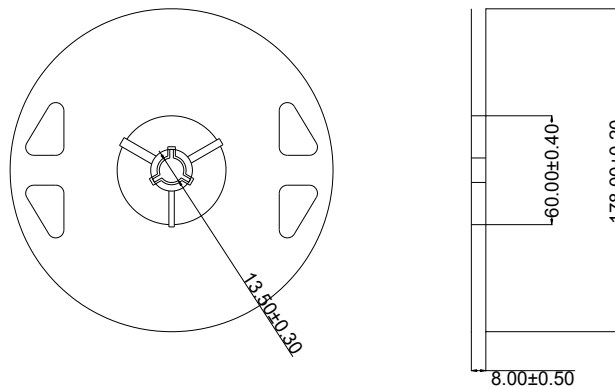

Moisture Resistant Packaging 防潮带包装

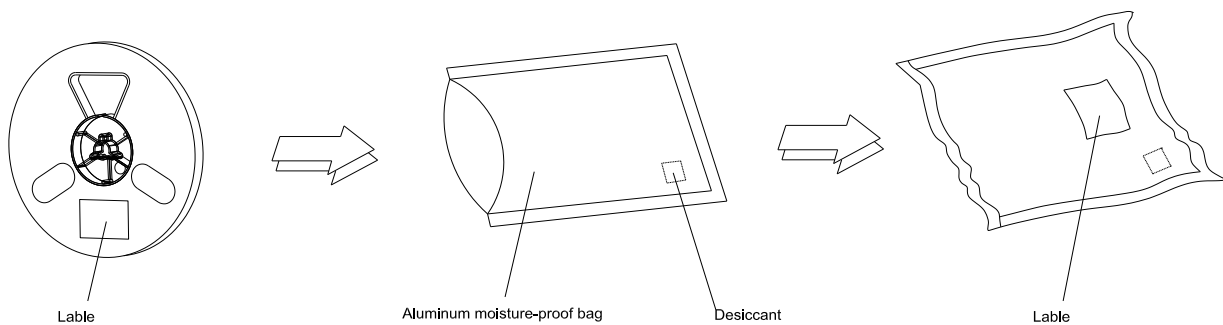

Note: The tolerances unless mentioned is $\pm 0.1\text{mm}$, Unit: mm 注: 标注公差为 $\pm 0.1\text{mm}$, 单位: mm

修订次数	修订人	修订内容	修订日期	版次
1	何剑飞	新建文件	2024.03.06	A0
2				
3				
4				
5				
6				
7				
8				
9				
10				
11				
12				
13				
14				
15				
16				
17				
18				
19				
20				
21				
22				
23				
24				
25				

X-ON Electronics

Largest Supplier of Electrical and Electronic Components

Click to view similar products for [Standard LEDs - SMD category](#):

Click to view products by [HONGLITRONIC manufacturer](#):

Other Similar products are found below :

[LTST-C190KYKT](#) [LTST-C19GD2WT](#) [LTW-170ZDC](#) [LTW-M140SZS40](#) [LTW-M140ZVS](#) [598-8110-100F](#) [598-8610-202F](#) [91-21SUBCS400-A6TR7](#) [AAAF5060QBFSEEZGS](#) [APT1608QGW](#) [99-213/R6C-AR2T1B/2C](#) [SML-LX0606SISUGC/A](#) [SML-LXR851SIUPGUBC](#) [LT1ED53A](#) [APFA3010SURKCGKQBDC](#) [APHK1608VGCA](#) [APT2012QGW](#) [LTST-008BGEW](#) [LTW-010DCG](#) [LTW-020ZDCG](#) [LTW-21TS5](#) [LTW-220DS5](#) [598-8330-117F](#) [65-21SYGC/S530-E3/TR8](#) [CMDA20AYAA7D1S](#) [95-21SURCS530-A3TR10](#) [598-8070-100F](#) [598-8140-100F](#) [598-8610-200F](#) [SML-LXR851SGSIC-TR](#) [SML-512PWT86A](#) [EASV3015RGYA0](#) [95-21UYC-S530-A5-TR7](#) [LTST-C190KFKT-5A](#) [LTST-C194TBKT-5A](#) [CLX6E-FKC-CH1M1D1BB7C3D3](#) [SML-LXL0805USBC-TR](#) [SML-LX2835SYSUGCTR](#) [LTW-M670ZVS-M5](#) [APA2106ZGC/G](#) [CLMXB-FKA-CbcfghjnpACBB79463](#) [KPTD-2012LVVBC-D](#) [VFA1101W-5AY3B2-TR](#) [LCB P473-P2R2-3J7L-1-Z](#) [91-21VGC/S556/S68/TR10/S370](#) [LW A67C-S2U1-FK0KM0](#) [LW A673-P1S1-FK0PM0](#) [BL-HE1G033B-TRB](#) [5988B90107F](#) [EL-19-21SURC/S530-A6](#)