

# HVB-3433EQXA



## 3433 PLCC6 系列产品 / Products Series

具有高发光效率、高一致性、高稳定性、高可靠性，主要用于汽车应用

High luminous efficiency, consistency, stability and reliability, it is mainly used in automobile applications.

### 特征

- 外观：白色PPA塑料，无色透明硅胶封装
- 50% I<sub>v</sub> 视角：120°
- 颜色：蓝色（470nm）
- 资格：通过了AEC-Q102 & IEC 60810可靠性测试
- 潮湿敏感等级-2

### Features

- Package: Colorless clear silicone in white PPA cup
- Viewing angle at 50% I<sub>v</sub>: 120°
- Color: Blue (470nm)
- Qualifications: Passed reliability test per AEC-Q102 & IEC 60810 requirement
- MSL-2

### 应用

- 信号灯
- 汽车内外部照明应用

### Applications

- Signaling
- Interior and exterior lighting for automotive

## 订购信息 / Ordering Information

型号 Type	发光强度 Luminous Intensity I <sub>v</sub> @ I <sub>f</sub> =140mA	订单编号 Ordering Code
HVB-3433EQXA- XXXX - XX - XX       亮度档 颜色档 电压档 Brightness Color Forward Voltage	1.80 -4.50 cd	XXXXXX

## 备注

## ■ 亮度档

单个最小包装只装有同一个亮度档次的产品，具体分档信息请见第4页

例如：HVB-3433EQXA-BACB-XX-XX，单个卷盘中的产品只有BA、BB、CA、CB中的某一档

## ■ 颜色档

单个最小包装只装有同一个颜色档次的产品，具体分档信息请见第4页

例如：HVB-3433EQXA-XXXX-35-XX，单个卷盘中的产品只有3、4、5中的某一档

## ■ 正向电压档

单个最小包装只装有同一个正向电压档次的产品，具体分档信息请见第4页

例如：HVB-3433EQXA-XXXX-XX-47，单个卷盘中的产品只有4、5、6、7中的某一档

## Note

## ■ Brightness Grouping

Only one brightness group will be packed in each reel. Please refer to page #4 for details.

E.g.: HVB-3433EQXA-BACB-XX-XX, means only one bin of BA, BB, CA or CB is in each reel.

## ■ Color Grouping

Only one color group will be packed in each reel. Please refer to page #4 for details.

E.g.: HVB-3433EQXA-XXXX-35-XX, means only one bin of 3, 4 or 5 is in each reel.

## ■ Forward Voltage Groups

Only one forward voltage group will be packed in each reel. Please refer to page #4 for details.

E.g.: HVB-3433EQXA-XXXX-XX-47, means only one bin of 4, 5, 6 or 7 is in each reel.

## 极限参数 / Maximum Ratings

参数 Parameters	符号 Symbol	数值 Rating	单位 Unit
结温 / Junction Temperature	$T_j$	125	°C
正向电流 / Forward Current ( $T_s=25^\circ\text{C}$ )	$I_f$	200	mA
峰值正向电流 Peak Forward Current ( $t \leq 10\mu\text{s}$ ; $D=0.005$ ; $T_s=25^\circ\text{C}$ )	$I_{fp}$	750	mA
反向电压 / Reverse Voltage ( $T_s=25^\circ\text{C}$ )	$V_r$	不可施加反向电压 / not designed for reverse operation	V
抗静电能力 Electrostatic Discharge (HBM)	$V_{ESD}$	2000	V
操作温度 / Operating Temperature	$T_{opr}$	-40 ~ +110	°C
储存温度 / Storage Temperature	$T_{stg}$	-40 ~ +110	°C

## 特性 / Characteristics ( $T_s = 25^\circ\text{C}$ ; $I_f = 140\text{ mA}$ )

参数 Parameters		符号 Symbol	数值 Rating	单位 Unit
峰值波长 / Wavelength at peak emission	typ.	$\lambda_{peak}$	465	nm
	min.	$\lambda_{dom}$	464	nm
主波长 / Dominant Wavelength	typ.	$\lambda_{dom}$	470	nm
	max	$\lambda_{dom}$	476	nm
半波宽 / Spectral bandwidth at 50% $I_{rel}$ max	typ.	$\Delta\lambda$	25	nm
50 % $I_v$ 下的视角 / Viewing Angle at 50 % $I_v$	typ.	$2\Phi$	120	°
	min.	$V_f$	2.90	V
	typ.	$V_f$	3.30	V
正向电压 / Forward Voltage	max	$V_f$	4.10	V
	typ.	$I_r$	不可施加反向电 压 / not designed for reverse operation	uA
反向电流 / Reverse Current ( $V_R=12\text{V}$ )	max.	$I_r$		uA
实际热阻值 (PN结-环境) / Real Thermal Resistance (Junction / Ambient)	max.	$R_{th JA_{real}}$	40	K/W
实际热阻值 (PN结-焊点) / Real Thermal Resistance (Junction / Solder Point)	max.	$R_{th JS_{real}}$	33	K/W

亮度分档 / Brightness Grouping ( $T_s = 25\text{ }^\circ\text{C}$ ;  $I_f = 140\text{ mA}$ )

档次 Grouping	发光强度 Luminous Intensity $I_v$ ( min. )	发光强度 Luminous Intensity $I_v$ ( max. )	光通量 Luminous Flux $\Phi_v$ ( typ. )
BA	1.80 cd	2.24 cd	6.30 lm
BB	2.24 cd	2.80 cd	7.90 lm
CA	2.80 cd	3.55 cd	9.90 lm
CB	3.55 cd	4.50 cd	12.60 lm

正向电压分档 / Forward Voltage Grouping ( $T_s = 25\text{ }^\circ\text{C}$ ;  $I_f = 140\text{ mA}$ )

档次 Grouping	正向电压 Forward Voltage $V_f$ ( min. )	正向电压 Forward Voltage $V_f$ ( max. )
4	2.90 V	3.20 V
5	3.20 V	3.50 V
6	3.50 V	3.80 V
7	3.80 V	4.10 V

主波长分档 / Dominant Wavelength Grouping ( $T_s = 25\text{ }^\circ\text{C}$ ;  $I_f = 140\text{ mA}$ )

档别 Grouping	主波长 Dominant Wavelength $\lambda_{\text{dom}}$ ( min )	主波长 Dominant Wavelength $\lambda_{\text{dom}}$ ( max )
3	464 nm	468 nm
4	468 nm	472 nm
5	472 nm	476 nm

## 标签信息 / Information on Label

例 / E.g.: BA-3-4

亮度档 Brightness	波长 Wavelength	正向电压 Forward Voltage
BA	3	4

相对发射光谱 -  $V(\lambda)$  = 标准人眼视觉曲线

Relative Spectral Emission -  $V(\lambda)$  = Standard Eye Response Curve

$I_{rel} = f(\lambda)$ ;  $T_s = 25\text{ }^\circ\text{C}$ ;  $I_f = 140\text{ mA}$

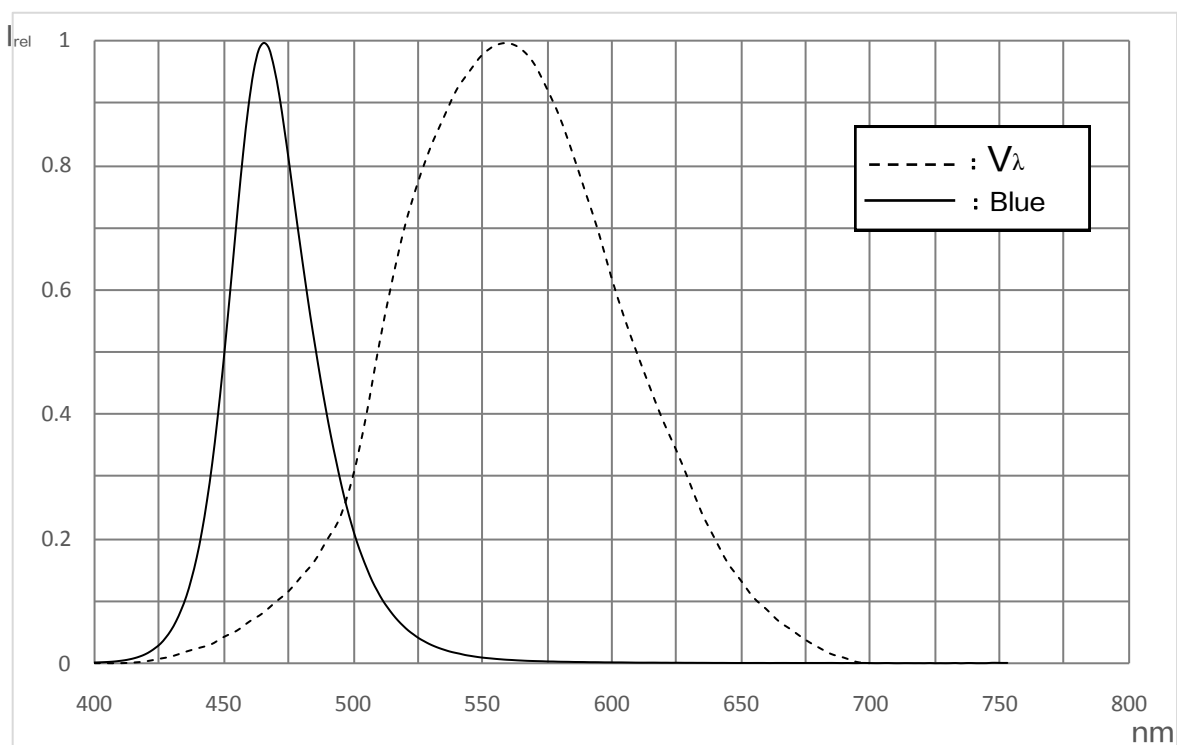

辐射特性 / Radiation Characteristics

$I_{rel} = f(\phi); T_s = 25\text{ }^\circ\text{C}$

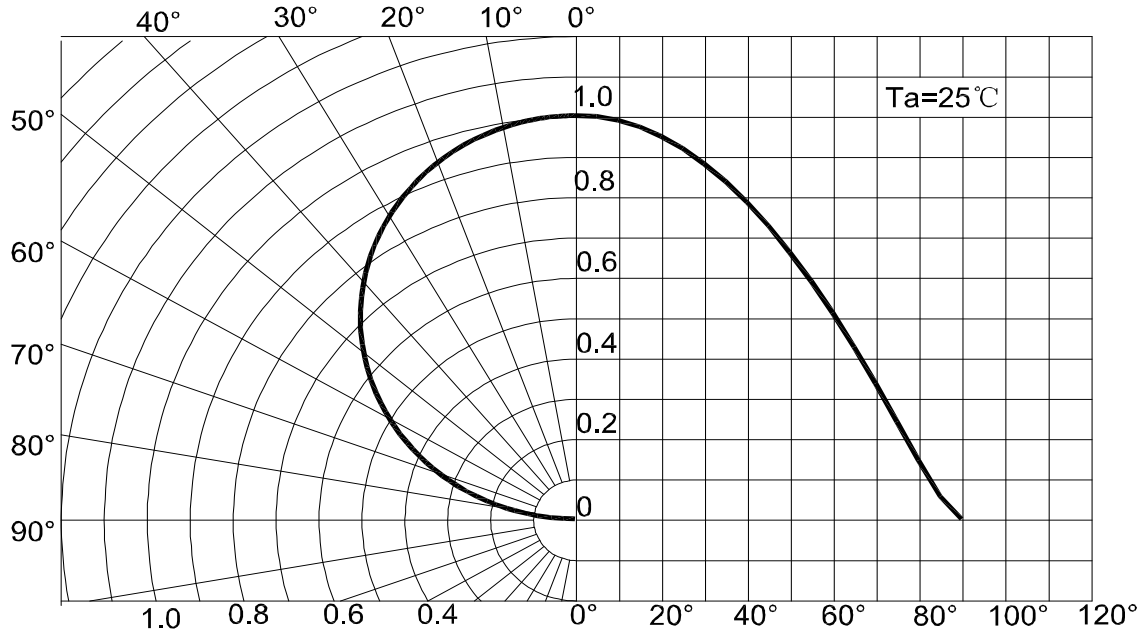

正向电流 / Forward Current

$I_f = f(V_f); T_a = 25\text{ }^\circ\text{C}$

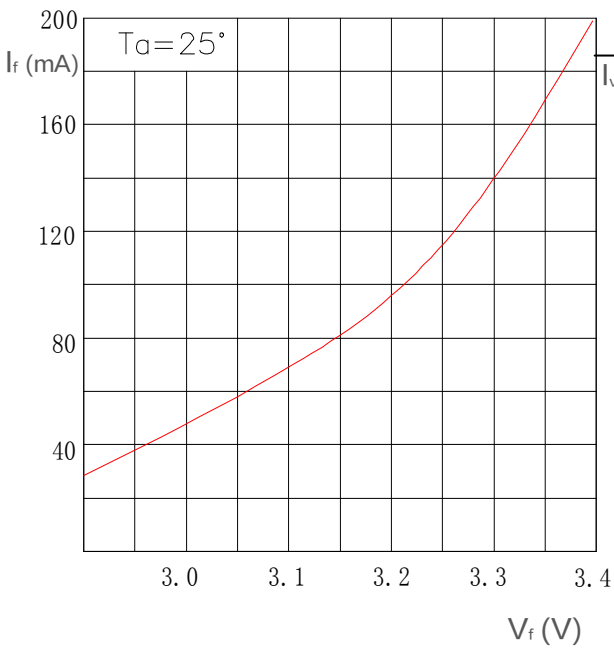

相对亮度特性曲线 / Relative Luminous Intensity

$I_v/I_v(140\text{ mA}) = f(I_f); T_a = 25\text{ }^\circ\text{C}$

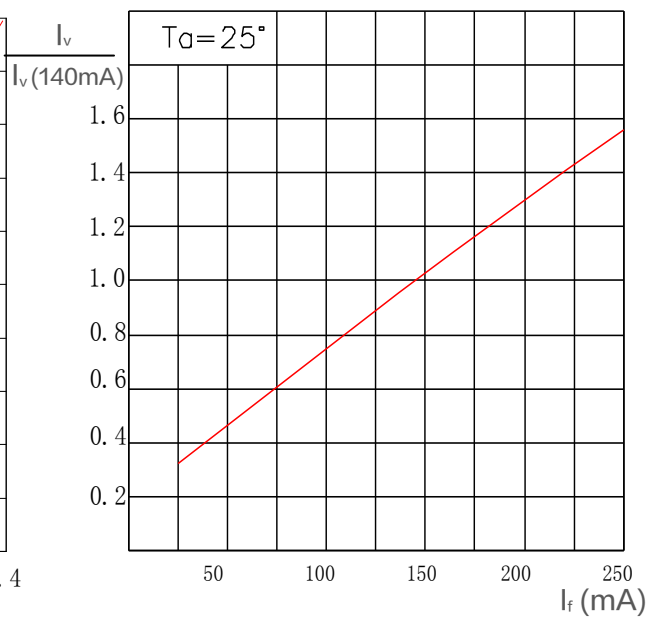

相对正向电压 / Relative Forward Voltage  
 $\Delta V_f = V_f - V_f(25^\circ\text{C}) = f(T_j); I_f = 140\text{ mA}$

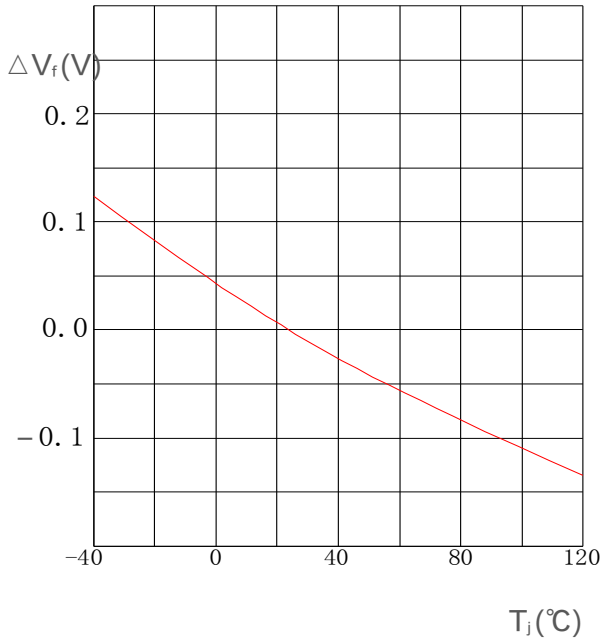

相对发光强度 / Relative Luminous Intensity  
 $I_v/I_v(25^\circ\text{C}) = f(T_j); I_f = 140\text{ mA}$

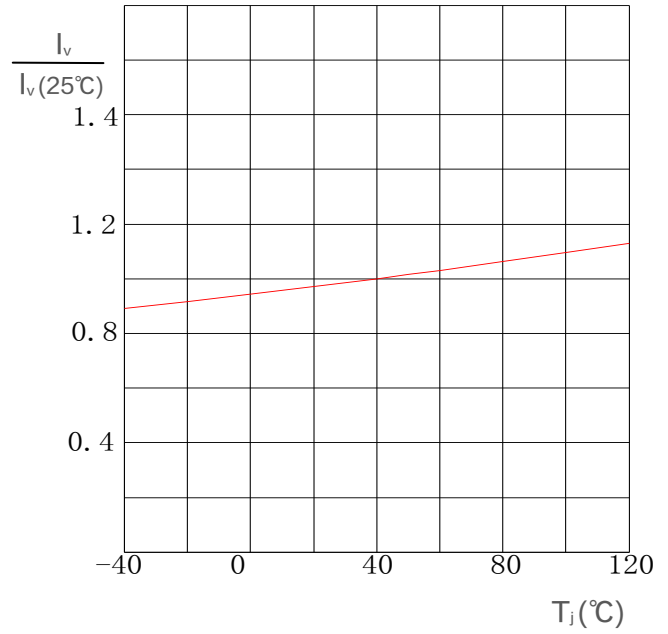

焊点温度与正向电流 / Solder point Temperature vs. Forward Current  
 $I_f = f(T_s)$

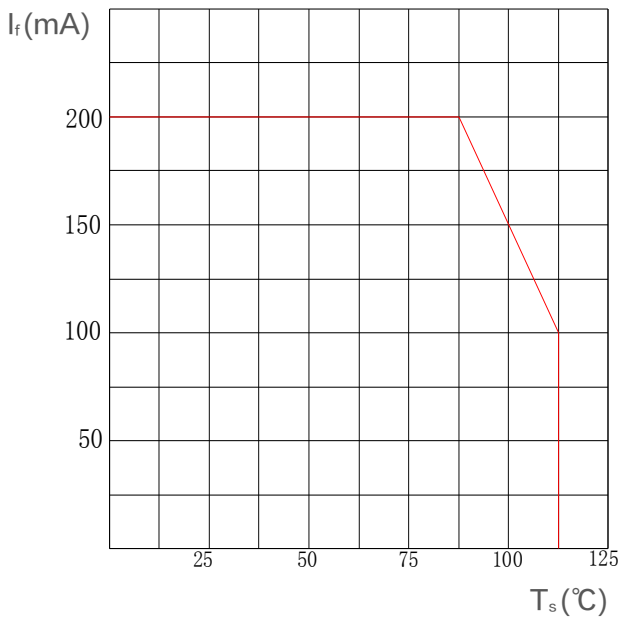

## 产品尺寸 / Package Outline

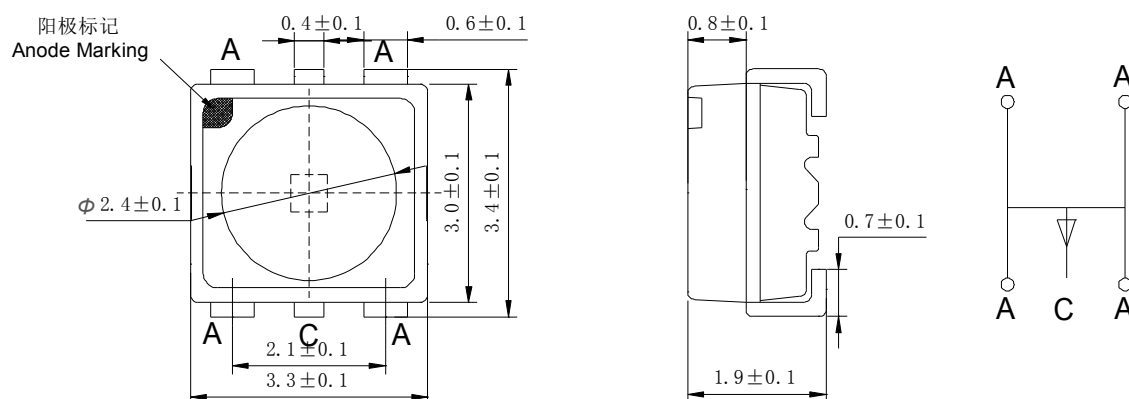

### 备注

■ 统计质量: 40mg

■ 标 记: 阳极

■ 腐蚀试验: 等级 3B

测试条件: 1) H<sub>2</sub>S 测试: 40°C / 90%R.H, 15ppm, 336小时 (标准IEC 60068-2-43)

2) 流动混合气体测试: 25°C / 75 %R.H, 500小时

(标准IEC 60068-2-60 方法 4: 10ppb H<sub>2</sub>S, 200ppb SO<sub>2</sub>, 200ppb NO<sub>2</sub>, 10ppb Cl<sub>2</sub>)

### NOTE

■ Approximate Weight: 30mg

■ Mark: Anode

■ Corrosion test: Class 3B

Test conditions: 1) H<sub>2</sub>S test: 40°C / 90%R.H, 15ppm, 336hours  
(Standards IEC 60068-2-43)

2) Flowing mixed gas test: 25°C / 75 %R.H, 500hours

(Standards IEC 60068-2-60 test method 4: 10ppb H<sub>2</sub>S, 200ppb SO<sub>2</sub>,  
200ppb NO<sub>2</sub>, 10ppb Cl<sub>2</sub>)

## 推荐焊盘 / Recommended Solder Pad

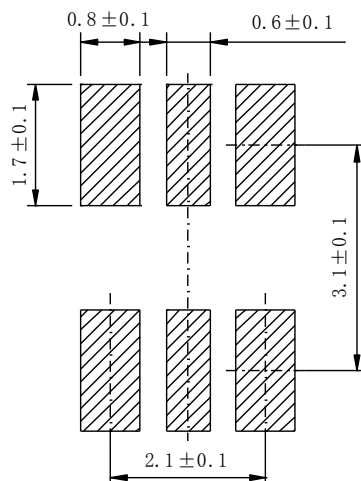

### 注释

■ 不适合超声波清洗的封装

### NOTE

■ Package not suitable for ultrasonic cleaning



## 回流焊要求 / Reflow Soldering Profile

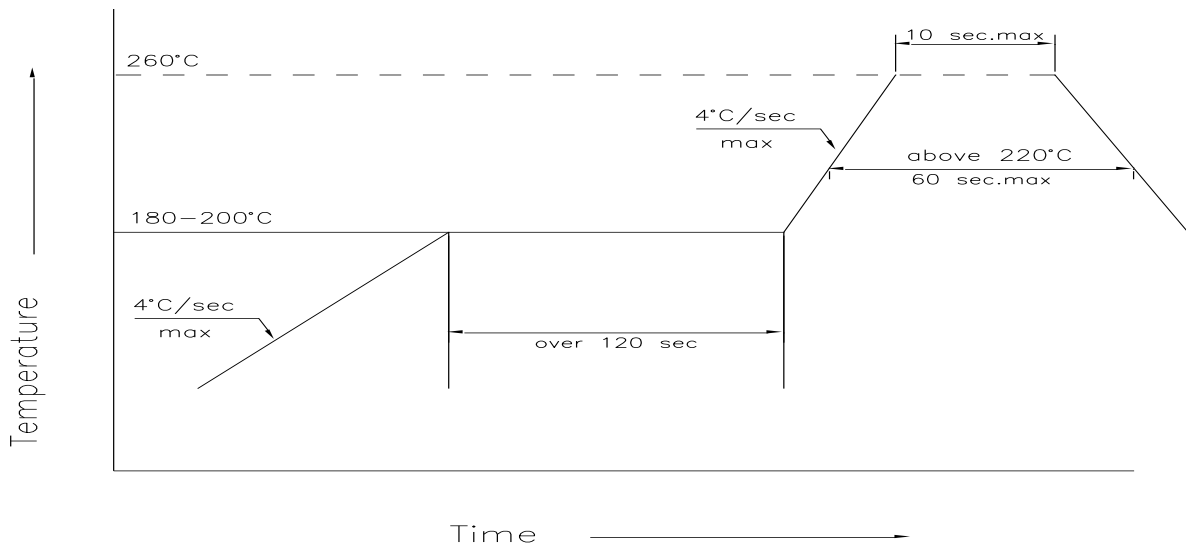

主要特性 Profile Feature	符号 Symbol	无铅焊接 Pb-Free (SnAgCu) Assembly			单位 Unit
		min.	rec.	max.	
预热升温速率 Ramp-up Rate to Preheat 25°C-150°C	-	-	2	3	°C/s
时间 / Time ( $T_{smin}$ to $T_{smax}$ )	$T_s$	60	100	120	s
峰值升温速率 Ramp-up Rate to Peak ( $T_{smax}$ to $T_p$ )	-	-	2	3	°C/s
熔点温度 Liquidus Temperature	$T_l$		217		°C
高于熔点温度的时间 Time above Liquidus Temperature	$t_l$	-	80	100	s
峰值温度 / Peak Temperature	$T_p$	-	255	260	°C
规定的峰值温度 ± 5°C 以内的时间 Time within 5°C of the Specified Peak Temperature	$t_p$	10	20	30	s
降温速率 / Ramp-down Rate ( $T_p$ to 100°C)	-	-	3	6	°C/s
时间 / Time (25°C to $T_p$ )	-	-	-	480	s

## 卷带与卷盘 / Tape and Reel

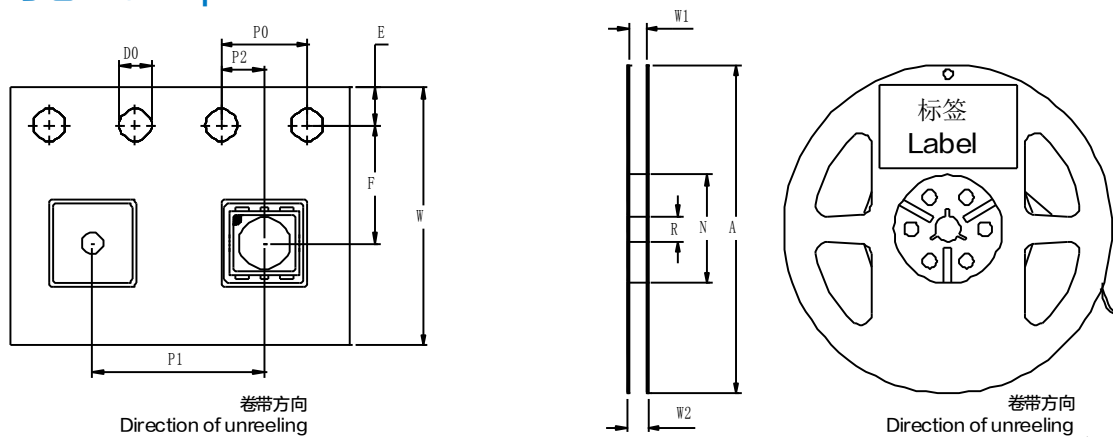

前端空带: 最小400 mm; 尾端空带: 最小160 mm; 尺寸符合: IEC 60286-3, EIA 481-D标准

Leader: min. 400 mm; Trailer: min. 160 mm; Requirement acc. to IEC 60286-3, EIA 481-D

## 卷带尺寸 / Tape Dimensions ( mm )

W	P0	P1	P2	D0	E	F
12±0.3	4±0.1	4±0.1	2±0.1	1.5+0.1/-0	1.75±0.1	5.5±0.1

## 卷盘尺寸 / Reel Dimensions ( mm )

A	W1	W2	N	R
177.8±0.1	12.7+2/-0.5	14.8+2/-0.5	58.5±0.2	13.5±0.2

## 数量 (颗/卷) / Quantity ( pcs/reel )

1000

## 条形码标签 / Barcode-Product-Label (BPL)

 **HONGLI TRONIC**  
鸿利光电

 **RoHS**

**Device No: HVX-XXXXXXX**  



**Lot No: XXXX-XXXXXXXX**  

**Product No: XXXXXXXXXXXXX**  

**Qty: XXXXPCS D/C: XXXX**  

**BIN: XX-XX-XX**  
**IV: XXXX-XXXX mcd**  
**WLD: XXX-XXX nm**  
**VF: XXX-XXX V**

 **MSL:2**



## 包装材料及过程 / Dry Packing Process and Materials

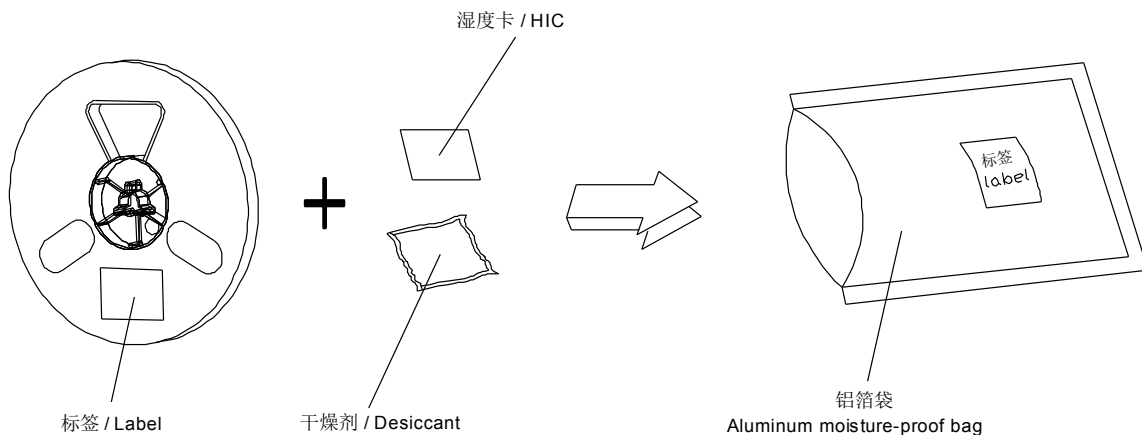

### 备注

产品包装在一个干燥的铝箔袋里，同时内附有干燥剂和湿度卡。  
对于干燥包装，您可以从网络或JEDEC标准里获取。

### NOTE

Moisture-sensitive product is packed in a dry bag containing desiccant and HIC (humidity indicator card).  
Regarding dry pack you may find further information in the internet or JEDEC.

## 出货包装及材料 / Transportation Packing and Materials

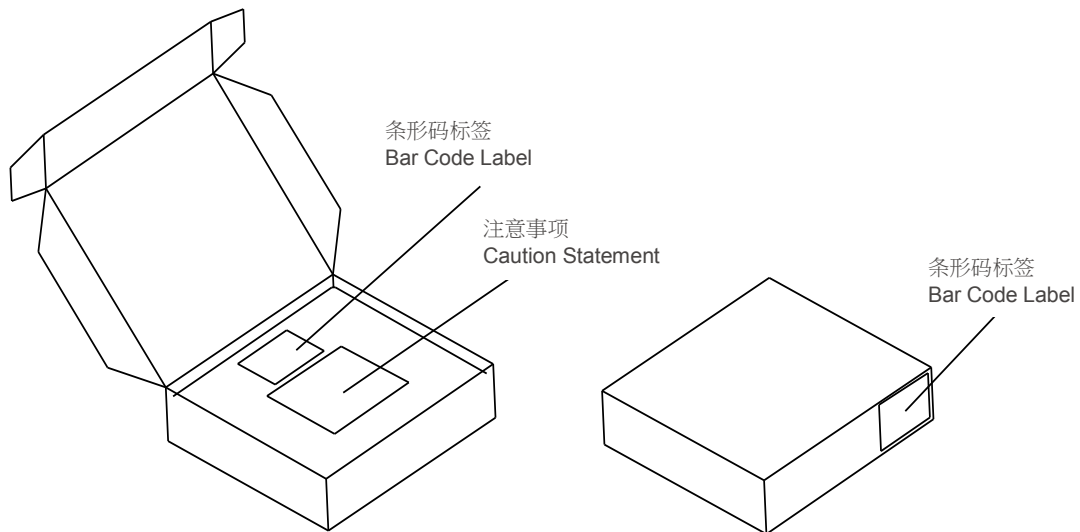

## 出货箱尺寸 / Dimensions of Transportation Box (mm)

宽度 / Width	长度 / Length	高度 / Height
256 ± 5	223 ± 5	62 ± 5
256 ± 5	223 ± 5	124 ± 5

## 注释

**典型值:** 每个产品的实际值可能与这些统计出的典型值不同。

**公差:** 除非图纸中有说明, 公差默认为  $\pm 0.1$  mm。

**正向电压:** 正向电压是在8ms脉冲电流并且内部在线性为  $\pm 0.05$ V和一个  $\pm 0.1$ V的外在不确定性 (按照GUM K=3因子) 来进行测试的。

**波长:** 波长是在25ms脉冲电流并且内部在线性为  $\pm 0.5$ nm和一个  $\pm 1$ nm的外在不确定性 (按照GUM K=3因子) 来进行测试的。

**亮度:** 亮度是在25ms脉冲电流并且内部在线性为  $\pm 8\%$ 和一个  $\pm 11\%$ 的外在不确定性 (按照GUM K=3因子) 来进行测试的。

**特殊声明:** 本版本最终解释权归属鸿利智汇, 当中英文意思发生歧义时, 以中文为准。

## Glossary

**Typical Values:** Actual values of each product may differ from these statistical values .

**Tolerance of Measure:** Unless otherwise noted in drawing, tolerances are specified with  $+/-0.1$ mm.

**Forward Voltage:** The forward voltage is measured during a current pulse of typically 8 ms, with an internal reproducibility of  $\pm 0.05$  V and an expanded uncertainty of  $\pm 0.1$  V (acc. to GUM with a coverage factor of  $k = 3$ ).

**Wavelength:** The wavelength is measured at a current pulse of typically 25 ms, with an internal reproducibility of  $\pm 0.5$  nm and an expanded uncertainty of  $\pm 1$  nm (acc. to GUM with a coverage factor of  $k = 3$ ).

**Brightness:** Brightness values are measured during a current pulse of typically 25 ms, with an internal reproducibility of  $\pm 8\%$  and an expanded uncertainty of  $\pm 11\%$  (acc. to GUM with a coverage factor of  $k = 3$ ).

**Special Statement:** The final interpretation of this specification shall be vested in Honglitronic, in the case of ambiguity, the Chinese version shall prevail.

## X-ON Electronics

Largest Supplier of Electrical and Electronic Components

*Click to view similar products for [Standard LEDs - SMD category](#):*

*Click to view products by [HONGLITRONIC manufacturer](#):*

Other Similar products are found below :

[LTST-C190KYKT](#) [LTST-C19GD2WT](#) [LTST-N683GBEW](#) [LTW-170ZDC](#) [LTW-M140SZS40](#) [LTW-M140ZVS](#) [598-8110-100F](#) [91-21SUBCS400-A6TR7](#) [AAAF5060QBFSEEZGS](#) [APT1608QGW](#) [99-213/R6C-AR2T1B/2C](#) [SML-LX0606SISUGC/A](#) [SML-LXR851SIUPGUBC](#) [LT1ED53A](#) [AM27ZGC03](#) [APFA3010SURKCGKQBDC](#) [APHK1608VGCA](#) [APT2012QGW](#) [LTST-008BGEW](#) [LTW-010DCG](#) [LTW-020ZDCG](#) [LTW-21TS5](#) [LTW-220DS5](#) [LO T67F-V1AB-24-1](#) [598-8330-117F](#) [CMDA20AYAA7D1S](#) [95-21SURCS530-A3TR10](#) [HSMQ-C177](#) [598-8040-100F](#) [598-8070-100F](#) [598-8140-100F](#) [598-8610-200F](#) [SML-LXL1209SYC/ATR](#) [CMD91-21VRC/TR7](#) [SML-512PWT86A](#) [SMF-2432GYC-TR](#) [EASV3015RGYA0](#) [LTST-C190KFKT-5A](#) [LTST-C194TBKT-5A](#) [CLX6E-FKC-CH1M1D1BB7C3D3](#) [SML-LXL0805USBC-TR](#) [SML-LX2835SYSUGCTR](#) [LTW-M670ZVS-M5](#) [APA2106ZGC/G](#) [CLMXB-FKA-CbcfghjnpACBB79463](#) [VFA1101W-5AY3B2-TR](#) [LCB P473-P2R2-3J7L-1-Z](#) [HSMR-C197](#) [LW A67C-S2U1-FK0KM0](#) [LW A673-P1S1-FK0PM0](#)