

# HVCB-2314KPX



## 2314 MINITOP 系列产品 / Products Series

具有高发光效率、高一致性、高稳定性、高可靠性，主要用于汽车应用

High luminous efficiency, consistency, stability and reliability, it is mainly used in automobile applications.

### 特征

- 外观：白色PPA塑料，有色硅树脂封装
- 50%  $I_v$  视角：120°
- 颜色：Cx=0.2, Cy=0.3 (CIE1931)
- 资格：可靠性测试符合AEC Q102
- 潮湿敏感等级-2

### Features

- Package: Colored Silicone resin in white PPA cup
- Viewing angle at 50%  $I_v$ : 120°
- Color: Cx=0.2, Cy=0.3 (acc. to CIE1931)
- Qualifications: Reliability test compliance with AEC Q102
- MSL-2

### 应用

- 信号灯
- 汽车内外部照明应用

### Applications

- Signaling
- Interior and exterior lighting for automotive

## 订购信息 / Ordering Information

型号 Type			发光强度 Luminous Intensity I <sub>v</sub> @ I <sub>f</sub> = 20mA	订购编号 Ordering Code
HVCB-2314KPX	- XXXX	- XXXX	- XXXX	
	I	I	I	
	亮度档	色坐标	电压档	710 - 2100 mcd
	Brightness	Chromaticity	Forward	XXXXXX
		Coordinate	Voltage	

## 备注

## ■ 亮度档

单个最小包装只装有同一个亮度档次的产品，具体分档信息请见第4页

例如：HVCB-2314KPX-V1BX-XX-XXXX，单个卷盘中的产品只有V1、V2、AX、AY、AZ、BX中的某一档

## ■ 颜色档

单个最小包装只装有同一个颜色档次的产品，具体分档信息请见第5页

例如：HVCB-2314KPX-2L8J-2L8J-XXXX，单个卷盘中的产品只有2J、2K、2L、3J、3K、3L...8J中的某一档

## ■ 正向电压档

单个最小包装只装有同一个正向电压档次的产品，具体分档信息请见第4页

例如：HVCB-2314KPX-XXXX-XX-5B7A，单个卷盘中的产品只有5B、6A、6B、7A中的某一档

## Note

## ■ Brightness Grouping

Only one brightness group will be packed in one reel. Please refer to page #4 for details.

E. g. : HVCB-2314KPX-V1BX-XX-XXXX, means only one bin of V1, V2, AX, AY, AZ, or BX is in one reel.

## ■ Color Groups

Only one color group will be packed in one reel. Please refer to page #5 for details.

E. g. : HVCB-2314KPX-XXXX-2L8J-XXXX, means only one bin of 2J, 2K, 2L, 3J, 3K, 3L..8J is in one reel.

## ■ Forward Voltage Groups

Only one forward voltage group will be packed in one reel. Please refer to page #4 for details.

E. g. : HVCB-2314KPX-XXXX-XX-5B7A, means only one bin of 5B, 6A, 6B or 7A is in one reel.

## 极限参数 / Maximum Ratings

参数 Parameters	符号 Symbol	数值 Rating	单位 Unit
结温 / Junction Temperature	$T_j$	125	°C
正向电流 / Forward Current ( $T_s=25^\circ\text{C}$ )	$I_f$	30	mA
峰值正向电流 Peak Forward Current ( $t \leq 10\mu\text{s}$ ; $D=0.005$ ; $T_s=25^\circ\text{C}$ )	$I_{fp}$	100	mA
反向电压 / Reverse Voltage ( $T_s=25^\circ\text{C}$ )	$V_r$	不适用于反向操作 Not designed for reverse operation	V
抗静电能力 Electrostatic Discharge (HBM)	$V_{ESD}$	2000	V
操作温度 / Operating Temperature	$T_{opr}$	-40 ~ +100	°C
储存温度 / Storage Temperature	$T_{stg}$	-40 ~ +100	°C

特性 / Characteristics ( $T_s = 25^\circ\text{C}$ ;  $I_f = 20\text{ mA}$ )

参数 Parameters	符号 Symbol	数值 Rating	单位 Unit
色坐标 / Chromaticity coordinates acc. to CIE 1931	typ.	$C_x$ 0.2	-
		$C_y$ 0.3	-
50 % $I_v$ 下的视角 / Viewing Angle at 50 % $I_v$	typ.	<b>2Φ</b> 120	°
	min.	$V_f$ 2.70	V
	typ.	$V_f$ 3.05	V
正向电压 / Forward Voltage	max.	$V_f$ 3.70	V
	typ.	$I_r$ 0.2	uA
反向电压 / Reverse Voltage ( $V_r$ ) =5V	Max.	$I_r$ 10	uA
	max.	$R_{th JS_{real}}$ 330	°C/W
实际热阻值 (PN结-焊点) / Real Thermal Resistance (Junction / Solder Point)			

亮度分档 / Brightness Grouping ( $T_s = 25\text{ }^\circ\text{C}$ ;  $I_f = 20\text{ mA}$ )

档次 Grouping	发光强度 Luminous Intensity $I_v$ (min. )	发光强度 Luminous Intensity $I_v$ (max. )
V1	710 mcd	900 mcd
V2	900 mcd	1120 mcd
AX	1120mcd	1300mcd
AY	1300 mcd	1500 mcd
AZ	1500 mcd	1800 mcd

正向电压分档 / Forward Voltage Grouping ( $T_s = 25\text{ }^\circ\text{C}$ ;  $I_f = 20\text{ mA}$ )

档次 Grouping	正向电压 Forward Voltage $V_f$ (min. )	正向电压 Forward Voltage $V_f$ (max. )
5B	2.70 V	2.90 V
6A	2.90 V	3.10 V
6B	3.10 V	3.40 V
7A	3.40 V	3.70 V

颜色色度分档/Colour Chromaticity Groups ( $T_s = 25\text{ }^\circ\text{C}$ ;  $I_f = 20\text{ mA}$ )

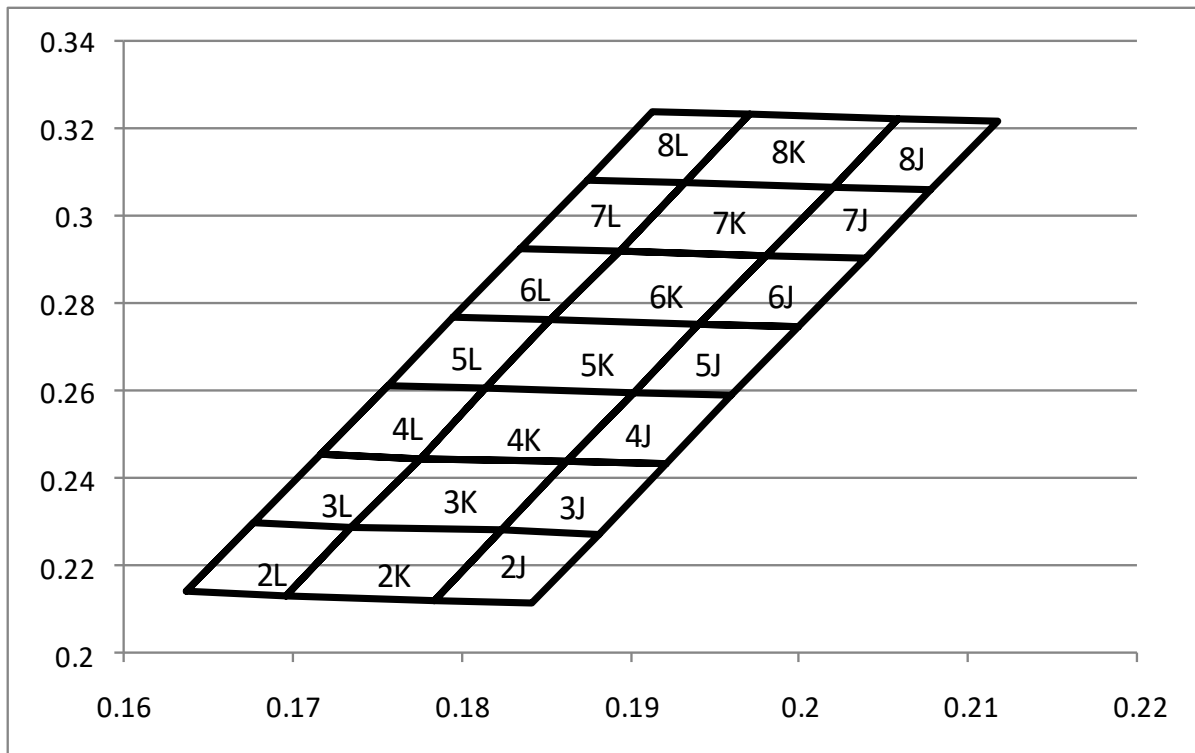

2J	0.1823	0.2280	3J	0.1862	0.2437	4J	0.1902	0.2595
	0.1882	0.2273		0.1921	0.2431		0.1960	0.2588
	0.1842	0.2116		0.1882	0.2273		0.1921	0.2431
	0.1784	0.2122		0.1823	0.2280		0.1862	0.2437
2K	0.1735	0.2290	3K	0.1775	0.2447	4K	0.1814	0.2605
	0.1823	0.2280		0.1862	0.2437		0.1902	0.2595
	0.1784	0.2122		0.1823	0.2280		0.1862	0.2437
	0.1696	0.2132		0.1735	0.2290		0.1775	0.2447
2L	0.1677	0.2296	3L	0.1716	0.2454	4L	0.1756	0.2611
	0.1735	0.2290		0.1775	0.2447		0.1814	0.2605
	0.1696	0.2132		0.1735	0.2290		0.1775	0.2447
	0.1637	0.2139		0.1677	0.2296		0.1716	0.2454

5J	0.1941	0.2753	6J	0.1980	0.2910	7J	0.2020	0.3068
	0.2000	0.2746		0.2039	0.2904		0.2078	0.3061
	0.1960	0.2588		0.2000	0.2746		0.2039	0.2904
	0.1902	0.2595		0.1941	0.2753		0.1980	0.2910
5K	0.1853	0.2762	6K	0.1893	0.2920	7K	0.1932	0.3078
	0.1941	0.2753		0.1980	0.2910		0.2020	0.3068
	0.1902	0.2595		0.1941	0.2753		0.1980	0.2910
	0.1814	0.2605		0.1853	0.2762		0.1893	0.2920
5L	0.1795	0.2769	6L	0.1834	0.2926	7L	0.1874	0.3084
	0.1853	0.2762		0.1893	0.2920		0.1932	0.3078
	0.1814	0.2605		0.1853	0.2762		0.1893	0.2920
	0.1756	0.2611		0.1795	0.2769		0.1834	0.2926
8J	0.2059	0.3225	8K	0.1971	0.3235	8L	0.1913	0.3242
	0.2118	0.3219		0.2059	0.3225		0.1971	0.3235
	0.2078	0.3061		0.2020	0.3068		0.1932	0.3078
	0.2020	0.3068		0.1932	0.3078		0.1874	0.3084

## 标签信息 / Information on Label

例 / E. g. : AZ-2L-6A

亮度档 / Brightness	颜色 / Color	正向电压 / Forward Voltage
AZ	2L	6A

相对发射光谱 -  $V(\lambda)$  = 标准人眼视觉曲线

Relative Spectral Emission -  $V(\lambda)$  = Standard Eye Response Curve

$I_{rel} = f(\lambda)$ ;  $T_s = 25\text{ }^\circ\text{C}$ ;  $I_f = 20\text{mA}$

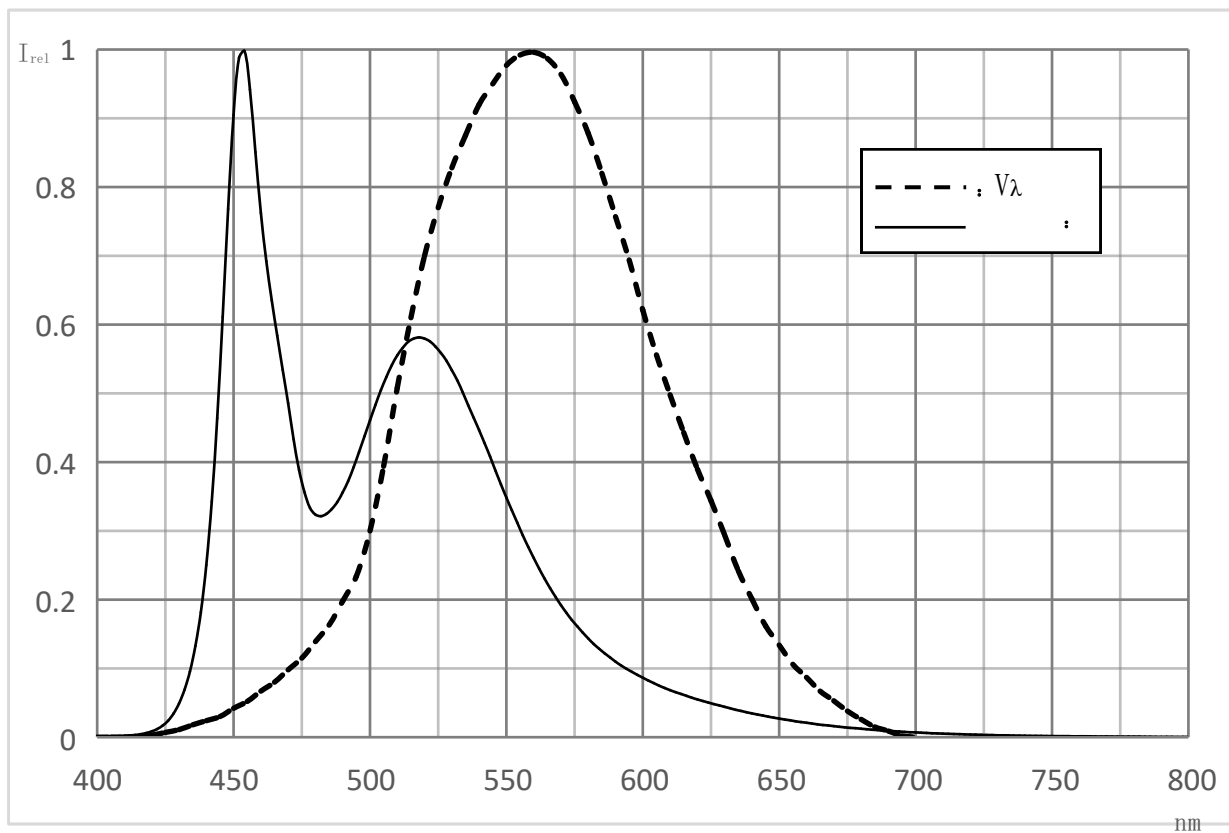

辐射特性 / Radiation Characteristics

$I_{rel} = f(\phi); T_s = 25\text{ }^\circ\text{C}$

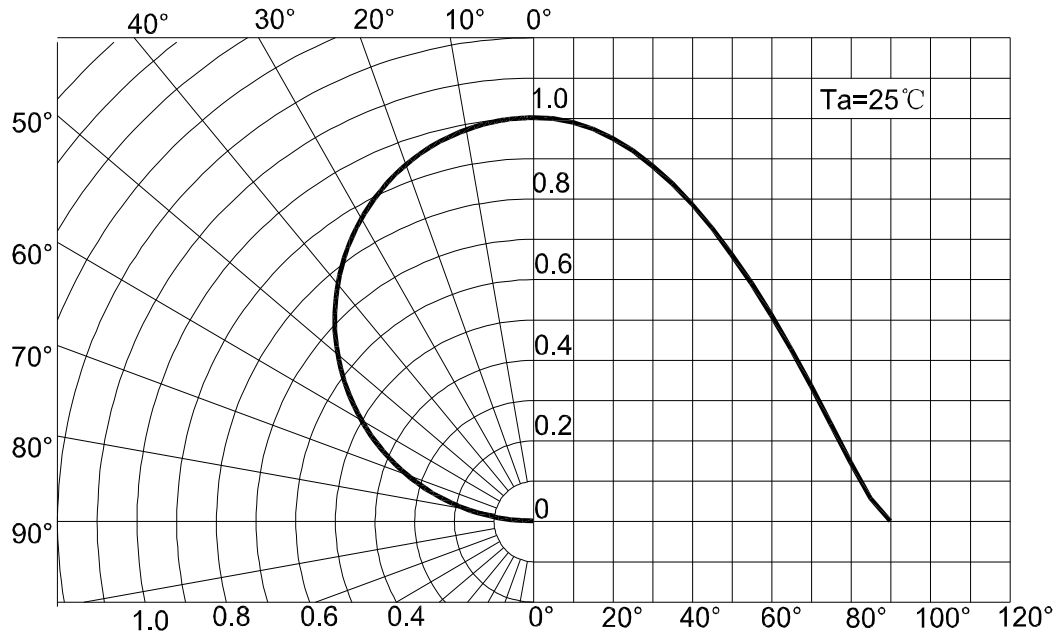

正向电流 / Forward Current

$I_f = f(V_f); T_a = 25\text{ }^\circ\text{C}$

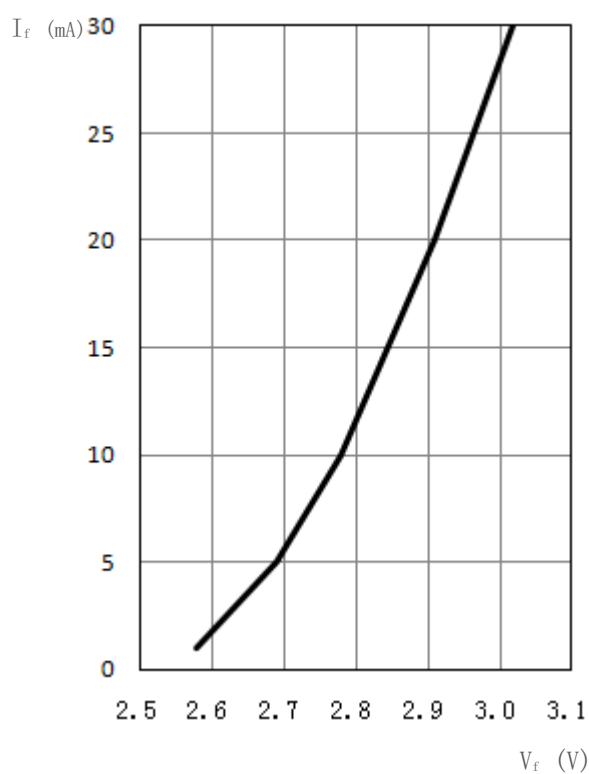

相对亮度特性曲线 / Relative Luminous Intensity

$I_v / I_v(20\text{mA}) = f(I_f); T_a = 25\text{ }^\circ\text{C}$

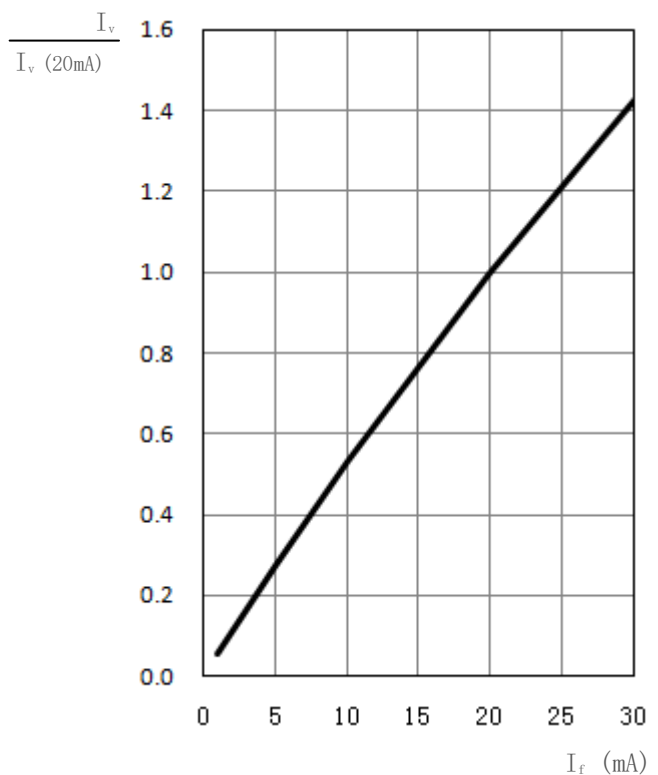



色坐标数据表/Chromaticity coordinate shift  
 $\Delta C_x, \Delta C_y = f(I_f); T_s = 25^\circ\text{C}$

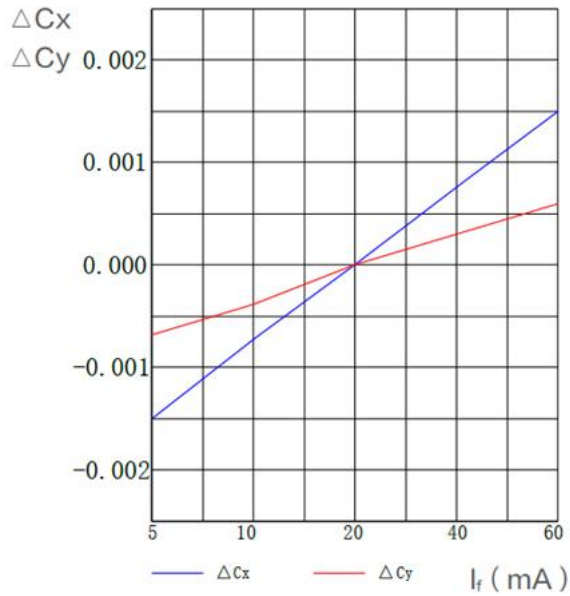

色坐标数据表/Chromaticity coordinate shift  
 $\Delta C_x, \Delta C_y = f(I_f); I_f = 20\text{mA}$

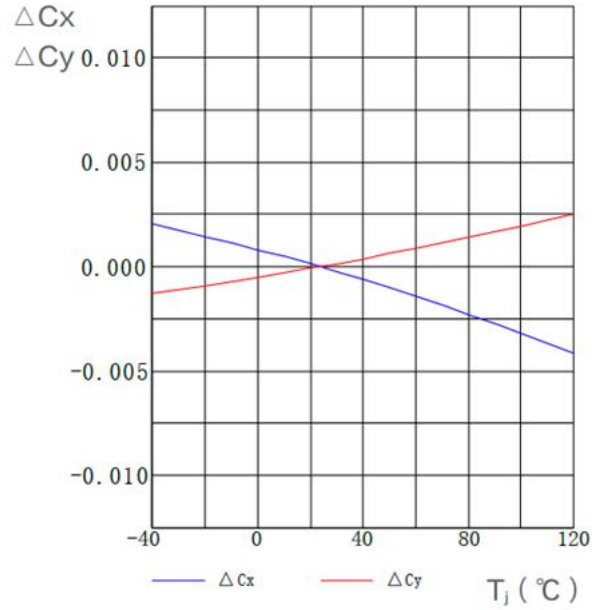

相对正向电压 / Relative Forward Voltage  
 $\Delta V_f = V_f - V_f(25^\circ\text{C}) = f(T_j); I_f = 20\text{ mA}$

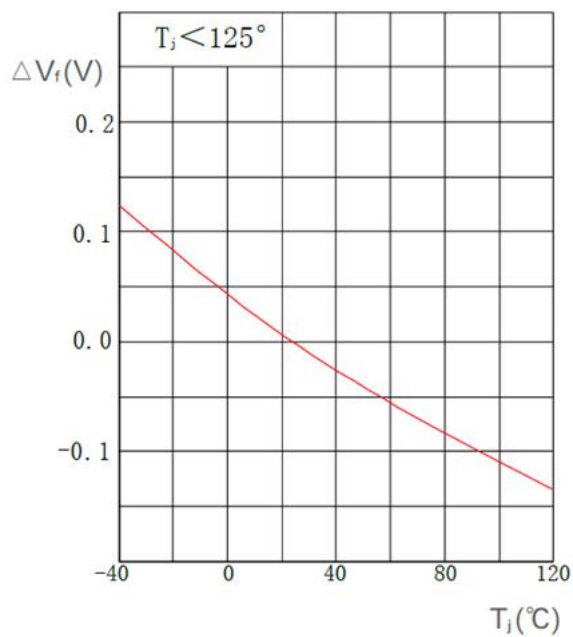

相对发光强度 / Relative Luminous Intensity  
 $I_v / I_v(25^\circ\text{C}) = f(T_j); I_f = 20\text{ mA}$

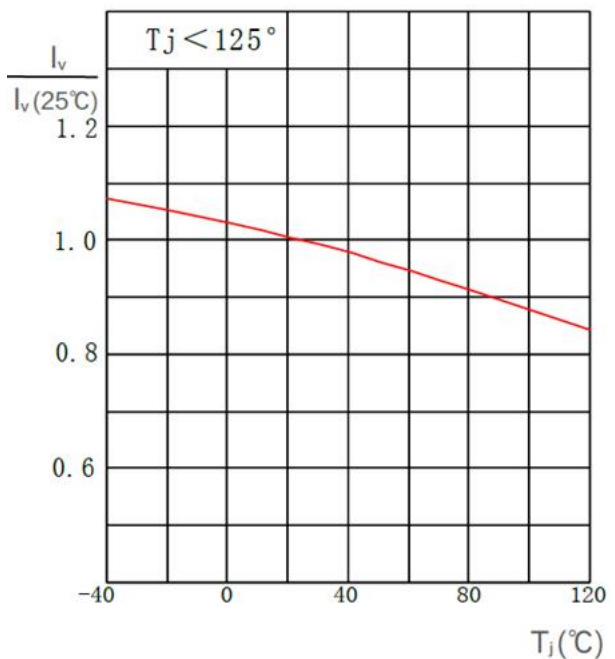

环境温度与正向电流

Ambient Temperature vs. Forward Current

$$I_f = f(T_a)$$

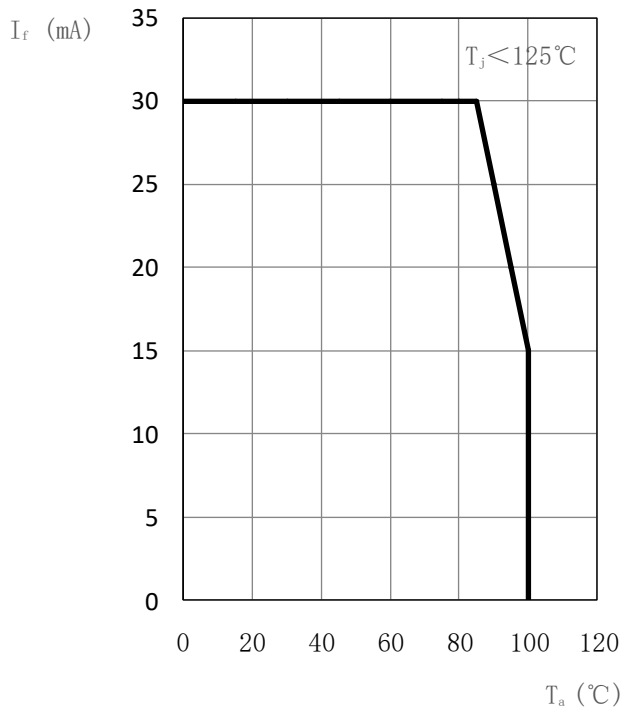

焊点温度与正向电流 / Solder Point Temperature vs. Forward Current

vs. Forward Current

$$I_f = f(T_s)$$

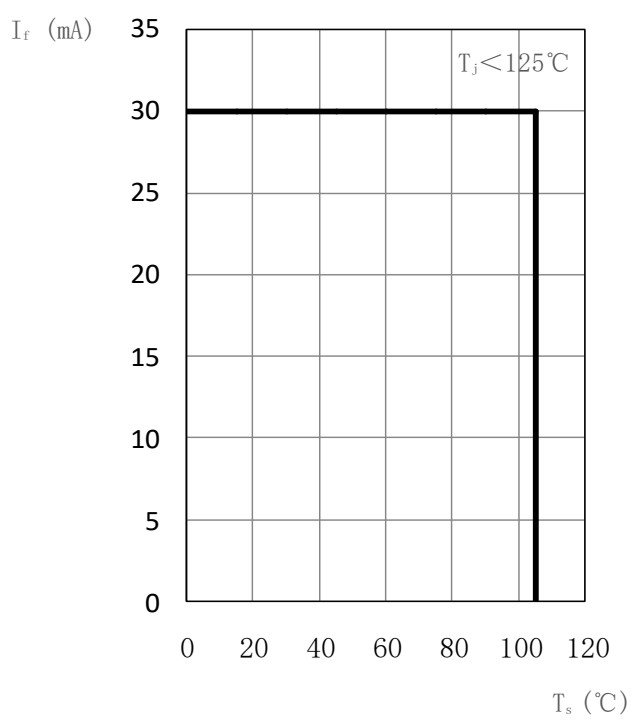

## 产品尺寸 / Package Outline

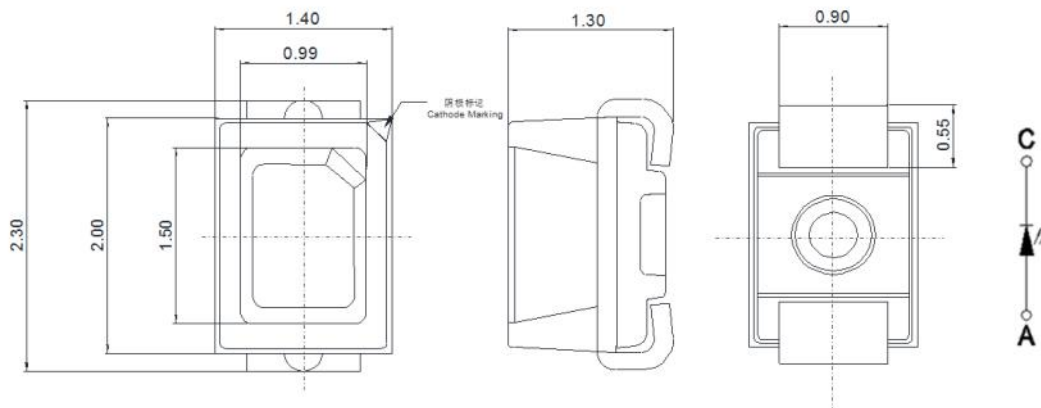

### 备注

- 统计质量: 10mg
- 标 记: 负极

### NOTE

- Approximate Weight: 10mg
- Mark: Cathode

## 推荐焊盘 / Recommended Solder Pad

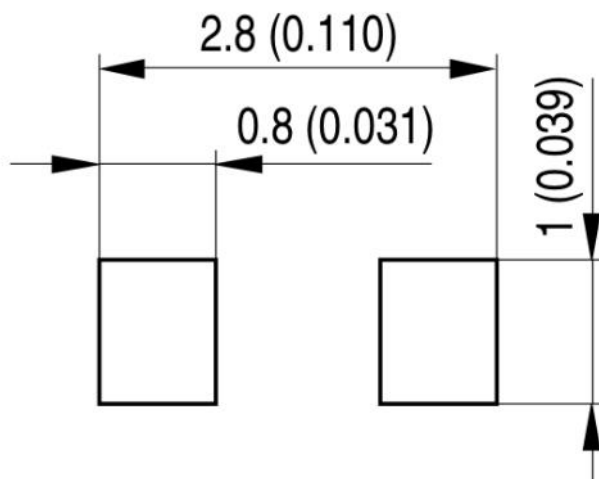

### 注释

- 不适合超声波清洗的封装

### NOTE

- Package not suitable for ultrasonic cleaning

## 回流焊要求 / Reflow Soldering Profile

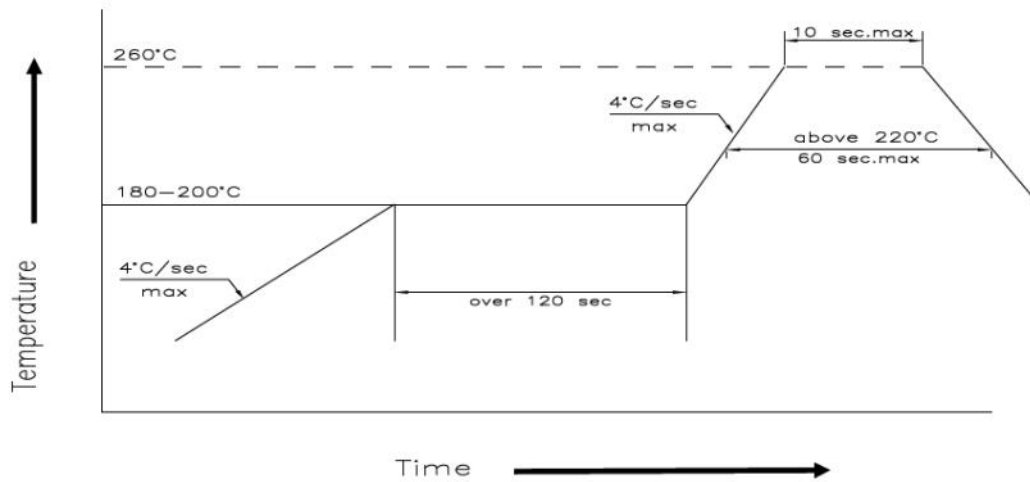

主要特性 Profile Feature	符号 Symbol	无铅焊接 Pb-Free Assembly			单位 Unit
		min.	rec.	max.	
预热升温速率 Ramp-up Rate to Preheat 25°C-150°C	-	-	2	3	°C/s
时间 / Time ( $T_{smin}$ to $T_{smax}$ )	$T_s$	60	100	120	s
峰值升温速率 Ramp-up Rate to Peak ( $T_{smax}$ to $T_p$ )	-	-	2	3	°C/s
熔点温度 Liquidus Temperature	$T_l$		217		°C
高于熔点温度的时间 Time above Liquidus Temperature	$t_l$	-	80	100	s
峰值温度 / Peak Temperature	$T_p$	-	255	260	°C
规定的峰值温度±5°C以内的时间 Time within 5°C of the Specified Peak Temperature	$t_p$	10	20	30	s
降温速率 / Ramp-down Rate ( $T_p$ to 100°C)	-	-	3	6	°C/s
时间 / Time (25°C to $T_p$ )	-	-	-	480	s

## 卷带与卷盘 / Tape and Reel

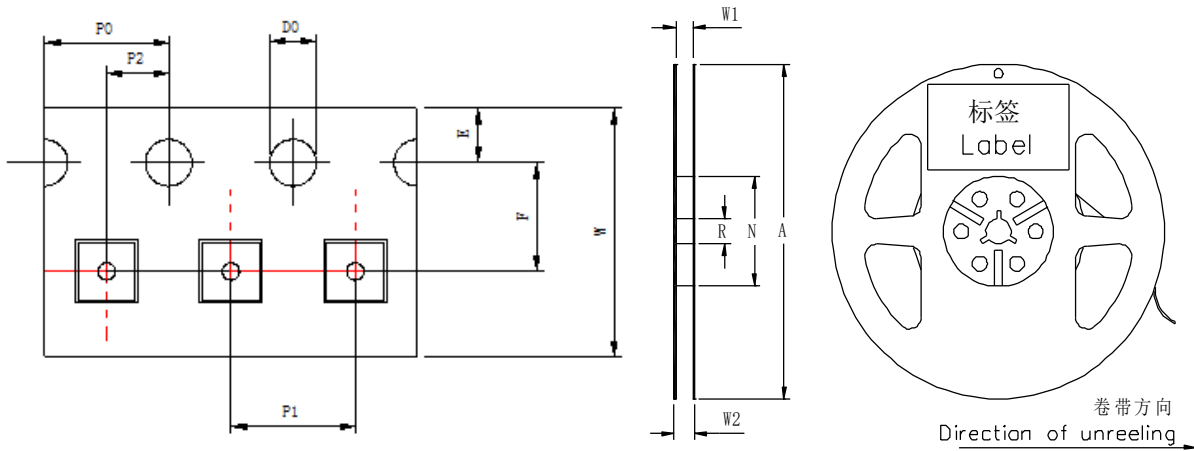

前端空带：最小400 mm；尾端空带： 最小160 mm；尺寸符合： IEC 60286-3, EIA 481-D标准  
 Leader: min. 400 mm; Trailer: min. 160 mm; Requirement acc. to IEC 60286-3, EIA 481-D

## 卷带尺寸 / Tape Dimensions (mm)

W	P0	P1	P2	D0	E	F
8±0.1	4±0.1	4±0.1	2±0.05	1.5±0.05	1.75±0.1	3.5±0.05

## 卷盘尺寸 / Reel Dimensions (mm)

A	W1	W2	N	R
177.8	9.3±0.3	11.2±0.3	58.5±0.2	13.5±0.2

## 数量 (颗/卷) / Quantity (pcs/reel)

3000

条形码标签 / Barcode-Product-Label (BPL)



包装材料及过程 / Dry Packing Process and Materials

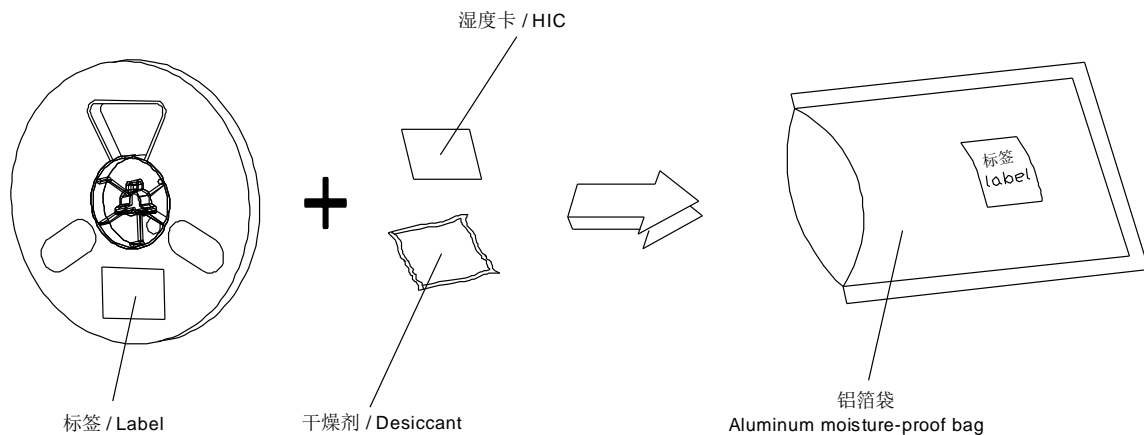

备注

产品包装在一个干燥的铝箔袋里，同时内附有干燥剂和湿度卡。  
对于干燥包装，您可以从网络或JEDEC标准里获取。

NOTE

Moisture-sensitive product is packed in a dry bag containing desiccant and HIC (humidity indicator card).  
Regarding dry pack you may find further information in the internet or JEDEC.

## 出货包装及材料 / Transportation Packing and Materials

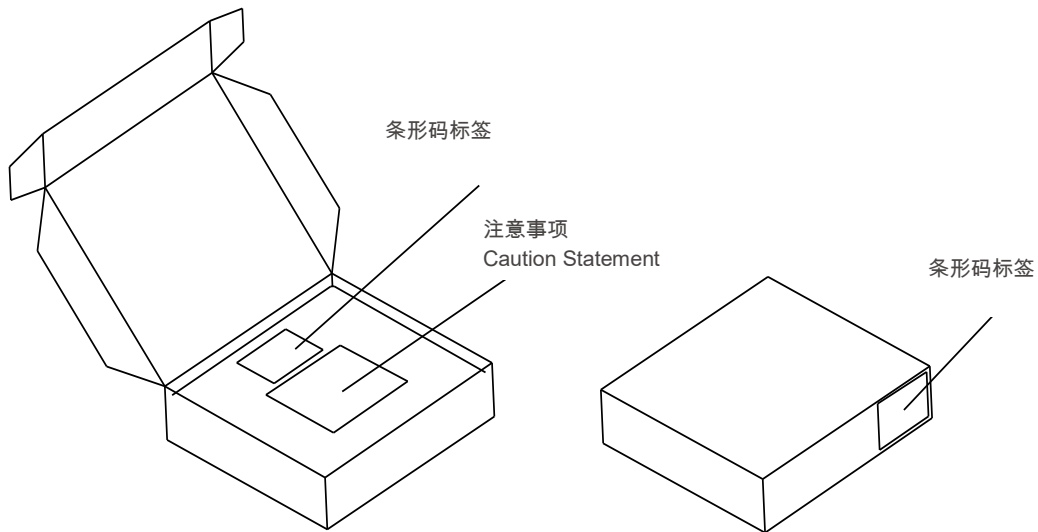

## 出货箱尺寸 / Dimensions of Transportation Box (mm)

宽度 / Width	长度 / Length	高度 / Height
256±5	223±5	62±5
256±5	223±5	124±5

## 注释

**典型值：** 每个产品的实际值可能与这些统计出的典型值不同。

**公差：** 除非图纸中有说明，公差默认为  $\pm 0.1$  mm。

**正向电压：** 正向电压是在8ms脉冲电流并且内部再现性为 $\pm 0.05$ V和一个 $\pm 0.1$ V的外在不确定性（按照GUM K=3因子）来进行测试的。

**色度坐标：** 色度坐标是在25ms脉冲电流并且内部再现性为 $\pm 0.005$ 和一个 $\pm 0.01$ 的外在不确定性（按照GUM K=3因子）来进行测试的。

**亮度：** 亮度是在25ms脉冲电流并且内部再现性为 $\pm 8\%$ 和一个 $\pm 11\%$ 的外在不确定性（按照GUM K=3因子）来进行测试的。

**特殊声明：** 本版本最终解释权归属鸿利智汇，当中英文意思发生歧义时，以中文为准。

## Glossary

**Typical Values:** Actual values of each product may differ from these statistical values .

**Tolerance of Measure:** Unless otherwise noted in drawing, tolerances are specified with +/-0.1mm.

**Forward Voltage:** The forward voltage is measured during a current pulse of typically 8 ms, with an internal reproducibility of  $\pm 0.05$  V and an expanded uncertainty of  $\pm 0.1$  V (acc. to GUM with a coverage factor of  $k = 3$ ).

**Chromaticity coordinate groups:** Chromaticity coordinate groups is measured at a current pulse of typically 25 ms, with an internal reproducibility of  $\pm 0.005$  and an expanded uncertainty of  $\pm 0.01$  (acc. to GUM with a coverage factor of  $k = 3$ ).

**Brightness:** Brightness values are measured during a current pulse of typically 25 ms, with an internal reproducibility of  $\pm 8\%$  and an expanded uncertainty of  $\pm 11\%$  (acc. to GUM with a coverage factor of  $k = 3$ ).

**Special Statement:** The final interpretation of this specification shall be vested in Hongli-tronic, in the case of ambiguity, the Chinese version shall prevail.



## X-ON Electronics

Largest Supplier of Electrical and Electronic Components

*Click to view similar products for [Standard LEDs - SMD category](#):*

*Click to view products by [HONGLITRONIC manufacturer](#):*

Other Similar products are found below :

[LTST-C190KYKT](#) [LTST-C19GD2WT](#) [LTST-N683GBEW](#) [LTW-170ZDC](#) [LTW-M140SZS40](#) [LTW-M140ZVS](#) [598-8110-100F](#) [91-21SUBCS400-A6TR7](#) [AAAF5060QBFSEEZGS](#) [APT1608QGW](#) [EAST2012YA0](#) [99-213/R6C-AR2T1B/2C](#) [SML-LX0606SISUGC/A](#) [SML-LXR851SIUPGUBC](#) [LT1ED53A](#) [AM27ZGC03](#) [APFA3010SURKCGKQBDC](#) [APHK1608VGCA](#) [APT2012QGW](#) [LTST-008BGEW](#) [LTW-010DCG](#) [LTW-020ZDCG](#) [LTW-21TS5](#) [LTW-220DS5](#) [LO T67F-V1AB-24-1](#) [598-8330-117F](#) [CMDA20AYAA7D1S](#) [95-21SURCS530-A3TR10](#) [HSMQ-C177](#) [598-8040-100F](#) [598-8070-100F](#) [598-8140-100F](#) [598-8610-200F](#) [SML-LXL1209SYC/ATR](#) [CMD91-21VRC/TR7](#) [SML-512PWT86A](#) [SMF-2432GYC-TR](#) [EASV3015RGYA0](#) [LTST-C190KFKT-5A](#) [LTST-C194TBKT-5A](#) [CLX6E-FKC-CH1M1D1BB7C3D3](#) [SML-LXL0805USBC-TR](#) [SML-LX2835SYSUGCTR](#) [LTW-M670ZVS-M5](#) [APA2106ZGC/G](#) [CLMXB-FKA-CbcfghjnpACBB79463](#) [VFA1101W-5AY3B2-TR](#) [LCB P473-P2R2-3J7L-1-Z](#) [HSMR-C197](#) [LW A67C-S2U1-FK0KM0](#)