

# HVCW-2835FPY

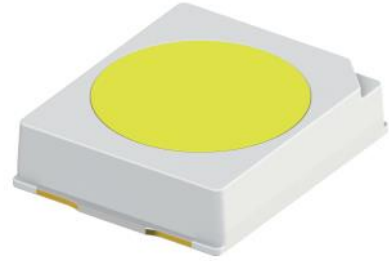

## 2835 PLCC2 系列产品 / Products Series

具有高发光效率、高一一致性、高稳定性、高可靠性，主要用于汽车应用

High luminous efficiency, consistency, stability and reliability, it is mainly used in automobile applications.

## 特征

- 外观：白色PCT塑料，荧光硅树脂封装
- 50%  $I_v$  视角： $120^\circ$
- 颜色： $C_x=0.32, C_y=0.32$  (CIE1931)
- 资格：可靠性测试符合AEC Q102和 IEC 60810标准
- 潮湿敏感等级-2

## Features

- Package: Colored diffused silicone resin in white PCT cup
- Viewing angle at 50%  $I_v$ :  $120^\circ$
- Color:  $C_x=0.32, C_y=0.32$  (acc. to CIE1931)
- Qualifications: Reliability test compliance with AEC Q102 and IEC 60810
- MSL-2

## 应用

- 信号灯
- 汽车内外部照明应用

## Applications

- Signaling
- Interior and exterior lighting for automotive

## 订购信息 / Ordering Information

| 型号<br>Type   |            |                            |                    | 发光强度<br>Luminous Intensity<br>$I_v @ I_f = 60\text{mA}$ | 订单编号<br>Ordering Code |
|--------------|------------|----------------------------|--------------------|---|-----------------------|
| HVCW-2835FPY | - XXXX     | - XXXX                     | - XX               |   |                       |
|              | I          | I                          | I                  |   |                       |
|              | 亮度档        | 色度坐标                       | 电压档                | 3.55 - 14.00cd  | XXXXXX                |
|              | Brightness | Chromaticity<br>Coordinate | Forward<br>Voltage |   |                       |

## 备注

## ■ 亮度档

单个最小包装只装有同一个亮度档次的产品，具体分档信息请见第4页

例如：HVCW-2835FPY-CBFA-XXXX-XX，单个卷盘中的产品只有CB、DA、DB、EA、EB、FA中的某一档

## ■ 色度坐标档

单个最小包装只装有同一个色度坐标档次的产品，具体分档信息请见第5页

例如：HVCW-2835FPY-XXXX-FKOPNO-XXXX，单个卷盘中的产品只有FKO、FLO、GKO、GLO、HKO、HLO……PNO 或 A、B 中的某一档

## ■ 正向电压档

单个最小包装只装有同一个正向电压档次的产品，具体分档信息请见第4页

例如：HVCW-2835FPY-XXXX-XXXX-58，单个卷盘中的产品只有5、6、7、8中的某一档

## Note

## ■ Brightness Grouping

Only one brightness group will be packed in each reel. Please refer to page #4 for details.

E. g. : HVCW-2835FPY-CBFA-XXXX-XX, means only one bin of CB, DA, DB, EA, EB, FA is in each reel.

## ■ Chromaticity Coordinate Groups

Only one Chromaticity Coordinate group will be packed in each reel. Please refer to page #5 for details.

E. g. : HVCW-2835FPY-XXXX-FKOPNO-XXXX, means only one bin of FKO, FLO, GKO, GLO, HKO, HLO……PNO or A, B is in one reel.

## ■ Forward Voltage Groups

Only one forward voltage group will be packed in each reel. Please refer to page #4 for details.

E. g. : HVCW-2835FPY-XXXX-XXXX-58, means only one bin of 5, 6, 7 or 8 is in each reel.

## 极限参数 / Maximum Ratings

| 参数<br>Parameters  | 符号<br>Symbol | 数值<br>Rating                                      | 单位<br>Unit |
|---|--------------|---|------------|
| 结温 / Junction Temperature   | $T_j$        | 125   | °C         |
| 正向电流 / Forward Current<br>( $T_s=25^\circ\text{C}$ )  | $I_f$        | 150   | mA         |
| 峰值正向电流<br>Peak Forward Current<br>( $t \leq 10\mu\text{s}$ ; $D=0.005$ ; $T_s=25^\circ\text{C}$ ) | $I_{fp}$     | 750   | mA         |
| 反向电压 / Reverse Voltage<br>( $T_s=25^\circ\text{C}$ )  | $V_r$        | 不适用于反向操作<br>Not designed for<br>reverse operation | V          |
| 抗静电能力<br>Electrostatic Discharge (HBM)  | $V_{ESD}$    | 2000  | V          |
| 操作温度 / Operating Temperature  | $T_{opr}$    | -40 ~ +110  | °C         |
| 储存温度 / Storage Temperature  | $T_{stg}$    | -40 ~ +110  | °C         |

特性 / Characteristics ( $T_s = 25^\circ\text{C}$ ;  $I_f = 60\text{ mA}$ )

| 参数<br>Parameters  |      | 符号<br>Symbol     | 数值<br>Rating   | 单位<br>Unit |
|---|------|------------------|--|------------|
| 色坐标 / Chromaticity coordinates acc. to<br>CIE 1931                    | typ. | $C_x$            | 0.32   | -          |
|   |      | $C_y$            | 0.32   |            |
| 50 % $I_v$ 下的视角 / Viewing Angle at 50 % $I_v$                         | typ. | $2\Phi$          | 120  | °          |
|   | min. | $V_f$            | 2.60   | V          |
|   | typ. | $V_f$            | 3.10   | V          |
| 正向电压 / Forward Voltage  | max. | $V_f$            | 3.80   | V          |
|   | typ. | $I_r$            | 不可施加反向<br>电压 / not<br>designed for<br>reverse<br>operation | uA         |
| 反向电流 / Reverse Current<br>( $V_R=5\text{V}$ )                         | max. | $I_r$            |  | uA         |
| 实际热阻值 (PN结-焊点) / Real Thermal<br>Resistance (Junction / Solder Point) | max. | $R_{th JS real}$ | 16   | K/W        |

亮度分档 / Brightness Grouping ( $T_s = 25\text{ }^\circ\text{C}$ ;  $I_f = 60\text{ mA}$ )

| 档次<br>Grouping | 发光强度                                  | 发光强度                                  | 光通量                           |
|----------------|---------------------------------------|---------------------------------------|-------------------------------|
|                | Luminous Intensity<br>$\Phi_v$ (min.) | Luminous Intensity<br>$\Phi_v$ (max.) | Luminous Flux<br>$I_v$ (typ.) |
| CB             | 3.55cd                                | 4.50cd                                | 12.10lm                       |
| DA             | 4.50cd                                | 5.60cd                                | 15.20lm                       |
| DB             | 5.60cd                                | 7.10cd                                | 19.10lm                       |
| EA             | 7.10cd                                | 9.00cd                                | 24.20lm                       |
| EB             | 9.00cd                                | 11.20cd                               | 30.30lm                       |
| FA             | 11.20cd                               | 14.00cd                               | 37.80lm                       |

正向电压分档 / Forward Voltage Grouping ( $T_s = 25\text{ }^\circ\text{C}$ ;  $I_f = 60\text{ mA}$ )

| 档次<br>Grouping | 正向电压                            | 正向电压                            |
|----------------|---------------------------------|---------------------------------|
|                | Forward Voltage<br>$V_f$ (min.) | Forward Voltage<br>$V_f$ (max.) |
| 5              | 2.60 V                          | 2.90 V                          |
| 6              | 2.90 V                          | 3.20 V                          |
| 7              | 3.20 V                          | 3.50 V                          |
| 8              | 3.50V                           | 3.80 V                          |

颜色色度分档1/Colour Chromaticity Groups 1 ( $T_s = 25\text{ }^\circ\text{C}$ ;  $I_f = 60\text{ mA}$ )

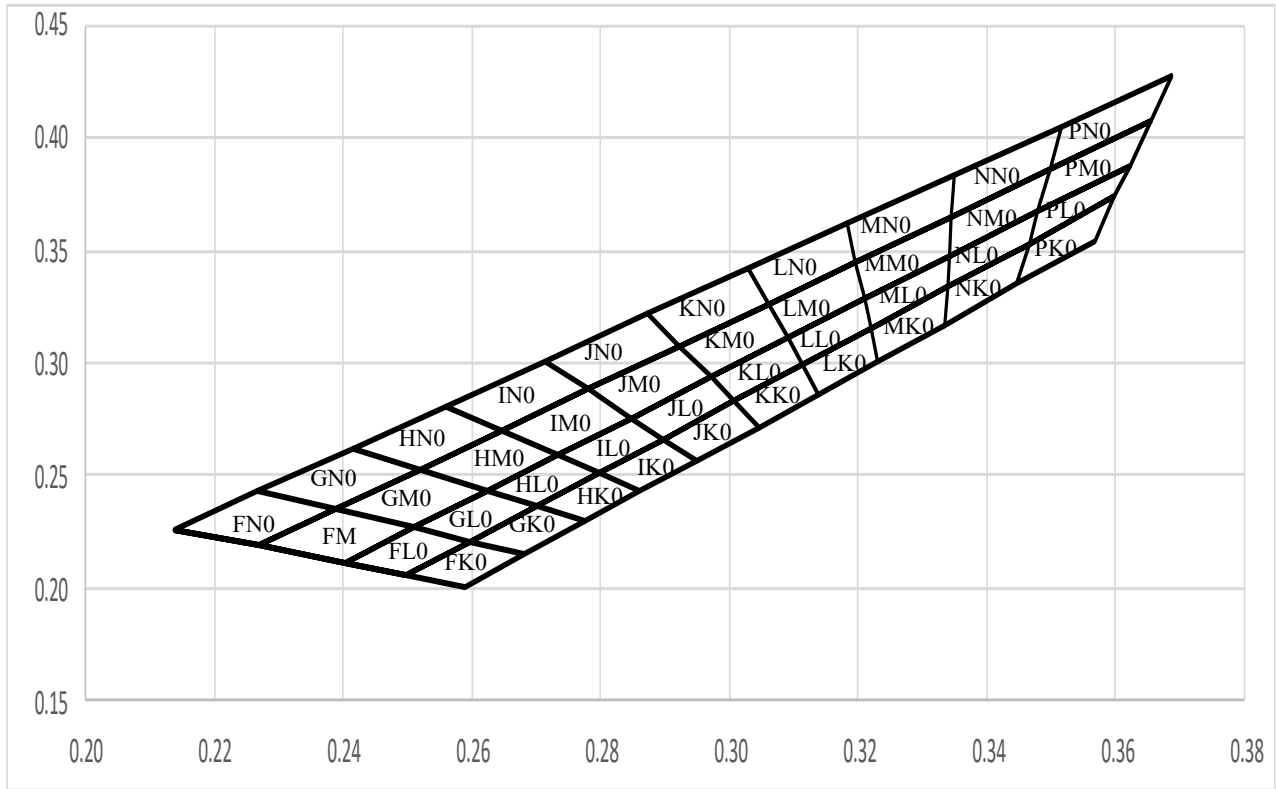

|     |        |        |     |        |        |     |        |        |
|-----|--------|--------|-----|--------|--------|-----|--------|--------|
| FKO | 0.2498 | 0.2053 | HKO | 0.2700 | 0.2361 | JKO | 0.2898 | 0.2664 |
|     | 0.2597 | 0.2204 |     | 0.2797 | 0.2509 |     | 0.3007 | 0.2830 |
|     | 0.2682 | 0.2146 |     | 0.2861 | 0.2427 |     | 0.3045 | 0.2717 |
|     | 0.2589 | 0.2000 |     | 0.2775 | 0.2292 |     | 0.2950 | 0.2568 |
| FLO | 0.2402 | 0.2108 | HLO | 0.2624 | 0.2431 | JLO | 0.2848 | 0.2757 |
|     | 0.2509 | 0.2264 |     | 0.2733 | 0.2590 |     | 0.2971 | 0.2935 |
|     | 0.2597 | 0.2204 |     | 0.2797 | 0.2509 |     | 0.3007 | 0.2830 |
|     | 0.2498 | 0.2053 |     | 0.2700 | 0.2361 |     | 0.2898 | 0.2664 |
| FMO | 0.2269 | 0.2185 | HMO | 0.2520 | 0.2527 | JMO | 0.2780 | 0.2883 |
|     | 0.2388 | 0.2348 |     | 0.2646 | 0.2700 |     | 0.2922 | 0.3077 |
|     | 0.2509 | 0.2264 |     | 0.2733 | 0.2590 |     | 0.2971 | 0.2935 |
|     | 0.2402 | 0.2108 |     | 0.2624 | 0.2431 |     | 0.2848 | 0.2757 |
| FNO | 0.2136 | 0.2262 | HNO | 0.2416 | 0.2623 | JNO | 0.2712 | 0.3009 |
|     | 0.2267 | 0.2432 |     | 0.2559 | 0.2810 |     | 0.2873 | 0.3219 |
|     | 0.2388 | 0.2348 |     | 0.2646 | 0.2700 |     | 0.2922 | 0.3077 |
|     | 0.2269 | 0.2185 |     | 0.2520 | 0.2527 |     | 0.2780 | 0.2883 |

|     |        |        |     |        |        |     |        |        |
|-----|--------|--------|-----|--------|--------|-----|--------|--------|
| GKO | 0.2597 | 0.2204 | IKO | 0.2797 | 0.2509 | KKO | 0.3007 | 0.2830 |
|     | 0.2700 | 0.2361 |     | 0.2898 | 0.2664 |     | 0.3113 | 0.2992 |
|     | 0.2775 | 0.2292 |     | 0.2950 | 0.2568 |     | 0.3138 | 0.2862 |
|     | 0.2682 | 0.2146 |     | 0.2861 | 0.2427 |     | 0.3045 | 0.2717 |
| GLO | 0.2509 | 0.2264 | ILO | 0.2733 | 0.2590 | KLO | 0.2971 | 0.2935 |
|     | 0.2624 | 0.2431 |     | 0.2848 | 0.2757 |     | 0.3090 | 0.3108 |
|     | 0.2700 | 0.2361 |     | 0.2898 | 0.2664 |     | 0.3113 | 0.2992 |
|     | 0.2597 | 0.2204 |     | 0.2797 | 0.2509 |     | 0.3007 | 0.2830 |
| GMO | 0.2388 | 0.2348 | IMO | 0.2464 | 0.2700 | KMO | 0.2922 | 0.3077 |
|     | 0.2520 | 0.2527 |     | 0.2780 | 0.2883 |     | 0.3060 | 0.3266 |
|     | 0.2624 | 0.2431 |     | 0.2848 | 0.2757 |     | 0.3090 | 0.3108 |
|     | 0.2509 | 0.2264 |     | 0.2733 | 0.2590 |     | 0.2971 | 0.2935 |
| GNO | 0.2267 | 0.2432 | INO | 0.2559 | 0.2810 | KNO | 0.2873 | 0.3219 |
|     | 0.2416 | 0.2623 |     | 0.2712 | 0.3009 |     | 0.3030 | 0.3424 |
|     | 0.2520 | 0.2527 |     | 0.2780 | 0.2883 |     | 0.3060 | 0.3266 |
|     | 0.2388 | 0.2348 |     | 0.2464 | 0.2700 |     | 0.2922 | 0.3077 |
| LKO | 0.3113 | 0.2992 | MMO | 0.3196 | 0.3451 | PKO | 0.3465 | 0.3530 |
|     | 0.3219 | 0.3154 |     | 0.3345 | 0.3654 |     | 0.3599 | 0.3735 |
|     | 0.3231 | 0.3008 |     | 0.3341 | 0.3472 |     | 0.3567 | 0.3535 |
|     | 0.3138 | 0.2862 |     | 0.3209 | 0.3281 |     | 0.3447 | 0.3347 |
| LLO | 0.3090 | 0.3108 | MNO | 0.3183 | 0.3621 | PLO | 0.3479 | 0.3673 |
|     | 0.3209 | 0.3281 |     | 0.3349 | 0.3830 |     | 0.3623 | 0.3882 |
|     | 0.3219 | 0.3154 |     | 0.3345 | 0.3654 |     | 0.3599 | 0.3735 |
|     | 0.3113 | 0.2992 |     | 0.3196 | 0.3451 |     | 0.3465 | 0.3530 |
| LMO | 0.3060 | 0.3266 | NKO | 0.3339 | 0.3336 | PMO | 0.3498 | 0.3863 |
|     | 0.3196 | 0.3451 |     | 0.3465 | 0.3530 |     | 0.3655 | 0.4079 |
|     | 0.3209 | 0.3281 |     | 0.3447 | 0.3347 |     | 0.3623 | 0.3882 |
|     | 0.3090 | 0.3108 |     | 0.3335 | 0.3172 |     | 0.3479 | 0.3673 |
| LNO | 0.3030 | 0.3424 | NLO | 0.3341 | 0.3472 | PNO | 0.3517 | 0.4053 |
|     | 0.3183 | 0.3621 |     | 0.3479 | 0.3673 |     | 0.3687 | 0.4276 |
|     | 0.3196 | 0.3451 |     | 0.3465 | 0.3530 |     | 0.3655 | 0.4079 |
|     | 0.3060 | 0.3266 |     | 0.3339 | 0.3336 |     | 0.3498 | 0.3863 |
| MKO | 0.3219 | 0.3154 | NMO | 0.3345 | 0.3654 |     |        |        |
|     | 0.3339 | 0.3336 |     | 0.3498 | 0.3863 |     |        |        |
|     | 0.3335 | 0.3172 |     | 0.3479 | 0.3673 |     |        |        |
|     | 0.3231 | 0.3008 |     | 0.3341 | 0.3472 |     |        |        |
| MLO | 0.3209 | 0.3281 | NNO | 0.3349 | 0.3830 |     |        |        |
|     | 0.3341 | 0.3472 |     | 0.3517 | 0.4053 |     |        |        |
|     | 0.3339 | 0.3336 |     | 0.3498 | 0.3863 |     |        |        |
|     | 0.3219 | 0.3154 |     | 0.3345 | 0.3654 |     |        |        |

颜色色度分档2/Colour Chromaticity Groups 2 ( $T_s = 25\text{ }^\circ\text{C}$ ;  $I_f = 60\text{ mA}$ )

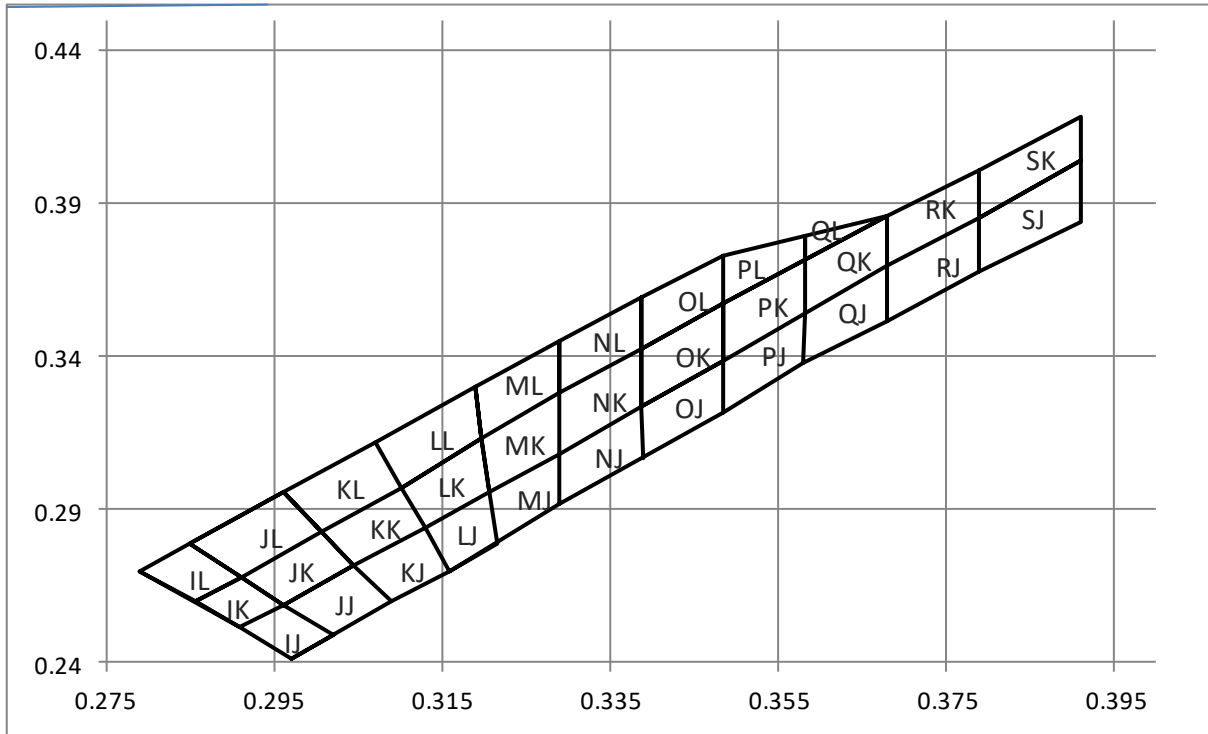

|    | X      | Y      |    | X      | Y      |    | X      | Y      |    | X      | Y      |
|----|--------|--------|----|--------|--------|----|--------|--------|----|--------|--------|
|    | 0.2910 | 0.2680 |    | 0.3100 | 0.2970 |    | 0.3288 | 0.3081 |    | 0.3484 | 0.3388 |
| JK | 0.2960 | 0.2590 | LK | 0.3130 | 0.2840 | NK | 0.3288 | 0.3282 | PK | 0.3484 | 0.3571 |
|    | 0.3005 | 0.2825 |    | 0.3197 | 0.3131 |    | 0.3386 | 0.3235 |    | 0.3582 | 0.3542 |
|    | 0.3045 | 0.2715 |    | 0.3205 | 0.2956 |    | 0.3386 | 0.3426 |    | 0.3582 | 0.3715 |
| JL | 0.2850 | 0.2790 | LL | 0.3070 | 0.3120 | NL | 0.3288 | 0.3282 | PL | 0.3484 | 0.3571 |
|    | 0.2910 | 0.2680 |    | 0.3100 | 0.2970 |    | 0.3288 | 0.3453 |    | 0.3484 | 0.3730 |
|    | 0.2960 | 0.2955 |    | 0.3189 | 0.3302 |    | 0.3386 | 0.3426 |    | 0.3582 | 0.3715 |
|    | 0.3005 | 0.2825 |    | 0.3197 | 0.3131 |    | 0.3386 | 0.3591 |    | 0.3582 | 0.3792 |
| KK | 0.3005 | 0.2825 | MK | 0.3197 | 0.3131 | OK | 0.3386 | 0.3235 | QK | 0.3582 | 0.3542 |
|    | 0.3045 | 0.2715 |    | 0.3205 | 0.2956 |    | 0.3386 | 0.3426 |    | 0.3582 | 0.3715 |
|    | 0.3100 | 0.2970 |    | 0.3288 | 0.3081 |    | 0.3484 | 0.3388 |    | 0.368  | 0.3859 |
|    | 0.3130 | 0.2840 |    | 0.3288 | 0.3282 |    | 0.3484 | 0.3571 |    | 0.368  | 0.3695 |
| KL | 0.2960 | 0.2955 | ML | 0.3189 | 0.3302 | OL | 0.3386 | 0.3426 | QL | 0.3582 | 0.3715 |
|    | 0.3005 | 0.2825 |    | 0.3197 | 0.3131 |    | 0.3386 | 0.3591 |    | 0.3582 | 0.3792 |
|    | 0.3070 | 0.3120 |    | 0.3288 | 0.3282 |    | 0.3484 | 0.3571 |    | 0.3680 | 0.3859 |
|    | 0.3100 | 0.2970 |    | 0.3288 | 0.3452 |    | 0.3484 | 0.3730 |    |        |        |

颜色色度分档2/Colour Chromaticity Groups 2 ( $T_s = 25\text{ }^\circ\text{C}$ ;  $I_f = 60\text{ mA}$ )

|    | X      | Y      |    | X      | Y      |    | X      | Y      |    | X      | Y      |
|----|--------|--------|----|--------|--------|----|--------|--------|----|--------|--------|
| IJ | 0.2960 | 0.2590 | JJ | 0.2960 | 0.2590 | KJ | 0.3130 | 0.2840 | LJ | 0.3205 | 0.2956 |
|    | 0.3020 | 0.2490 |    | 0.3045 | 0.2715 |    | 0.3159 | 0.2700 |    | 0.3215 | 0.2790 |
|    | 0.2970 | 0.2410 |    | 0.3090 | 0.2600 |    | 0.3090 | 0.2600 |    | 0.3159 | 0.2700 |
|    | 0.2908 | 0.2518 |    | 0.2970 | 0.2410 |    | 0.3045 | 0.2715 |    | 0.3130 | 0.2840 |
| MJ | 0.3288 | 0.3081 | NJ | 0.3386 | 0.3235 | OJ | 0.3484 | 0.3388 | PJ | 0.3582 | 0.3542 |
|    | 0.3290 | 0.2920 |    | 0.3390 | 0.3070 |    | 0.3485 | 0.3220 |    | 0.3580 | 0.3380 |
|    | 0.3159 | 0.2700 |    | 0.3159 | 0.2700 |    | 0.3159 | 0.2700 |    | 0.3485 | 0.3220 |
|    | 0.3090 | 0.2600 |    | 0.3090 | 0.2600 |    | 0.3090 | 0.2600 |    | 0.3090 | 0.2600 |
| QJ | 0.368  | 0.3695 | RK | 0.3680 | 0.3859 | RJ | 0.379  | 0.385  | SK | 0.3790 | 0.4010 |
|    | 0.368  | 0.3515 |    | 0.3790 | 0.4010 |    | 0.379  | 0.368  |    | 0.3910 | 0.4180 |
|    | 0.358  | 0.338  |    | 0.3790 | 0.3850 |    | 0.368  | 0.3515 |    | 0.3910 | 0.4040 |
|    | 0.3582 | 0.3542 |    | 0.3680 | 0.3695 |    | 0.368  | 0.3695 |    | 0.3790 | 0.3850 |
| SJ | 0.3790 | 0.3850 |    |        |        |    |        |        |    |        |        |
|    | 0.3910 | 0.4040 |    |        |        |    |        |        |    |        |        |
|    | 0.3910 | 0.3840 |    |        |        |    |        |        |    |        |        |
|    | 0.3790 | 0.3680 |    |        |        |    |        |        |    |        |        |



颜色色度分档2/Colour Chromaticity Groups 2 ( $T_s = 25\text{ }^\circ\text{C}$ ;  $I_f = 60\text{ mA}$ )

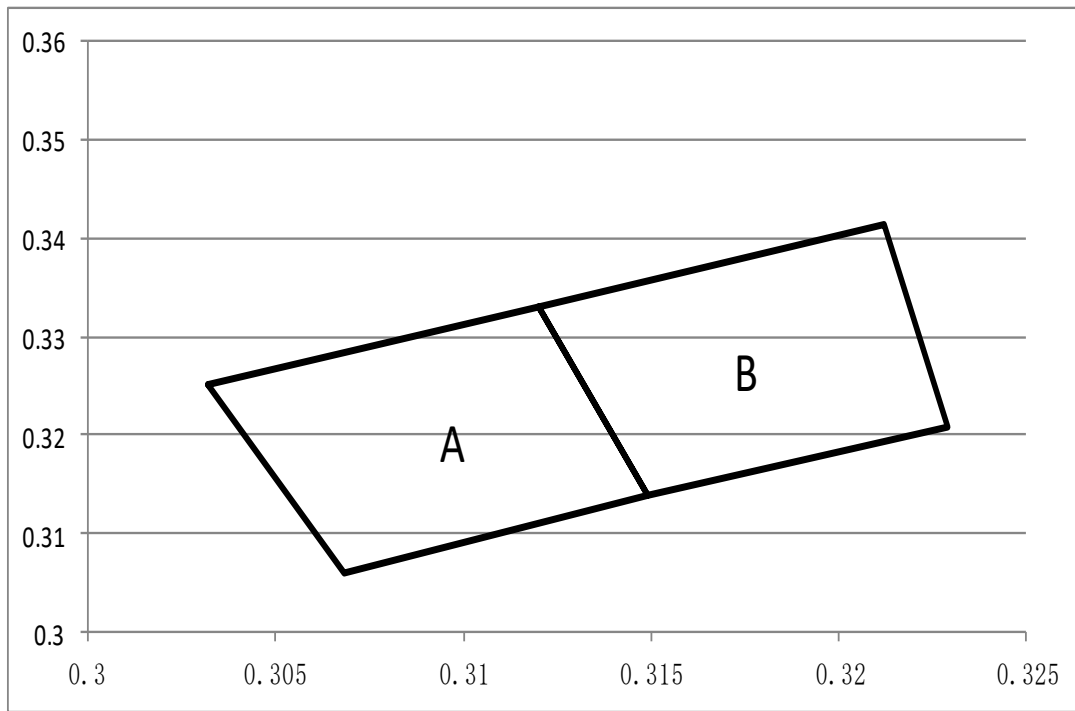

|   | X      | Y      |   | X      | Y      |
|---|--------|--------|---|--------|--------|
| A | 0.3032 | 0.325  | B | 0.312  | 0.333  |
|   | 0.312  | 0.333  |   | 0.3212 | 0.3414 |
|   | 0.3149 | 0.3139 |   | 0.3229 | 0.3207 |
|   | 0.3068 | 0.3059 |   | 0.3149 | 0.3139 |
|   | 0.3032 | 0.325  |   | 0.312  | 0.333  |

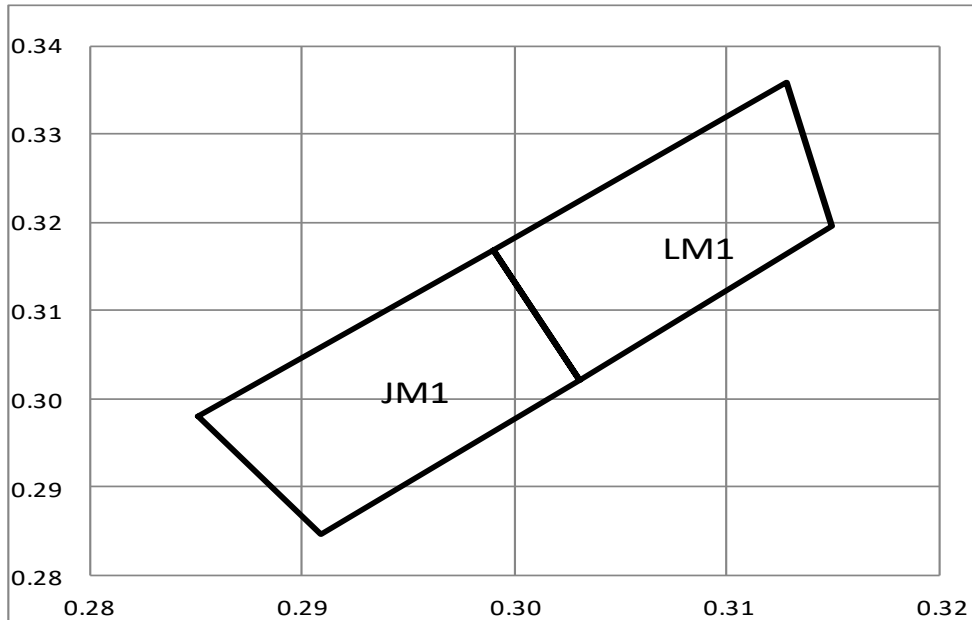
颜色色度分档3/Colour Chromaticity Groups 3 ( $T_s = 25\text{ }^\circ\text{C}$ ;  $I_f = 60\text{ mA}$ )

|     | X      | Y      |     | X      | Y      |
|-----|--------|--------|-----|--------|--------|
|     | 0.2851 | 0.2980 |     | 0.2990 | 0.3169 |
| JM1 | 0.2990 | 0.3169 | LM1 | 0.3128 | 0.3359 |
|     | 0.3031 | 0.3022 |     | 0.3150 | 0.3195 |
|     | 0.2910 | 0.2846 |     | 0.3031 | 0.3022 |

## 标签信息 / Information on Label

例 / E. g. : CB-FK0-5

| 亮度档 / Brightness | 颜色 / Color | 正向电压 / Forward Voltage |
|------------------|------------|------------------------|
| CB               | FK0        | 5                      |

相对发射光谱 -  $V(\lambda)$  = 标准人眼视觉曲线

Relative Spectral Emission -  $V(\lambda)$  = Standard Eye Response Curve

$I_{rel} = f(\lambda)$ ;  $T_s = 25\text{ }^\circ\text{C}$ ;  $I_f = 60\text{ mA}$

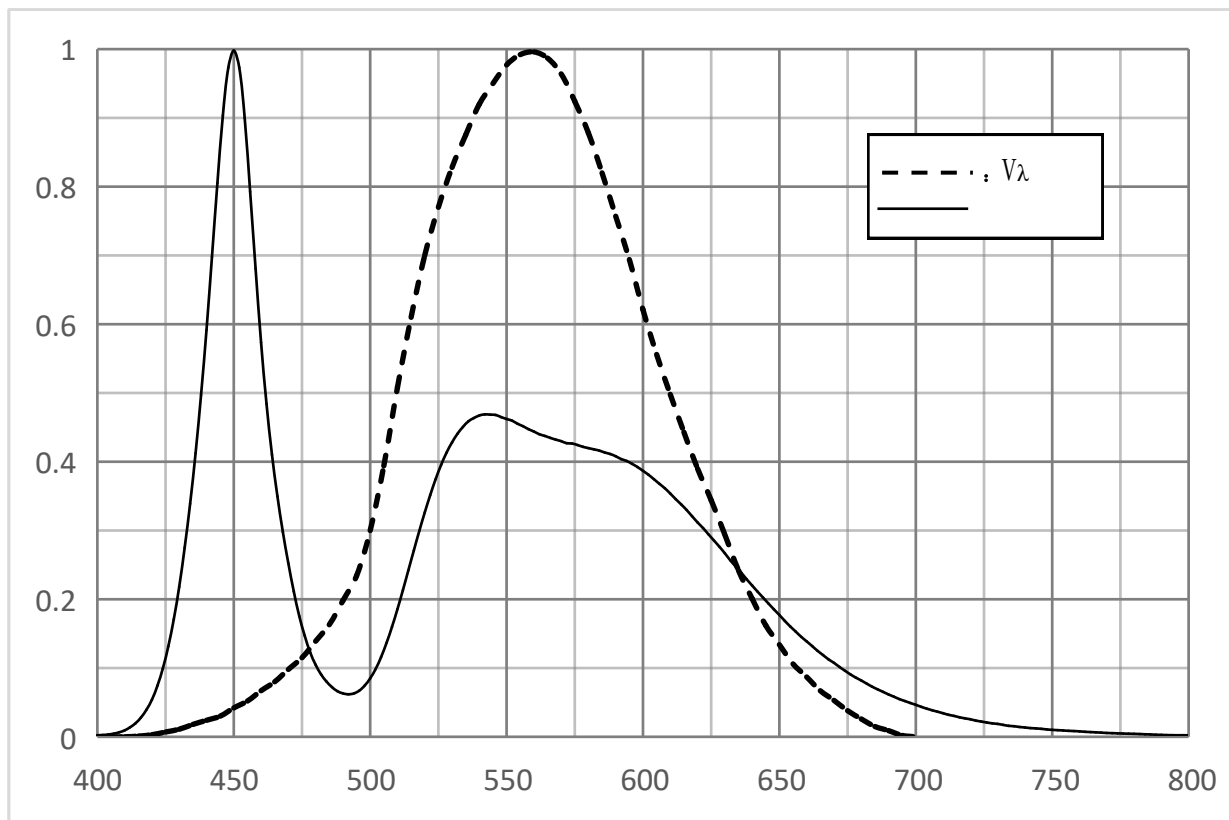

辐射特性 / Radiation Characteristics

$I_{rel} = f(\phi); T_s = 25\text{ }^\circ\text{C}$

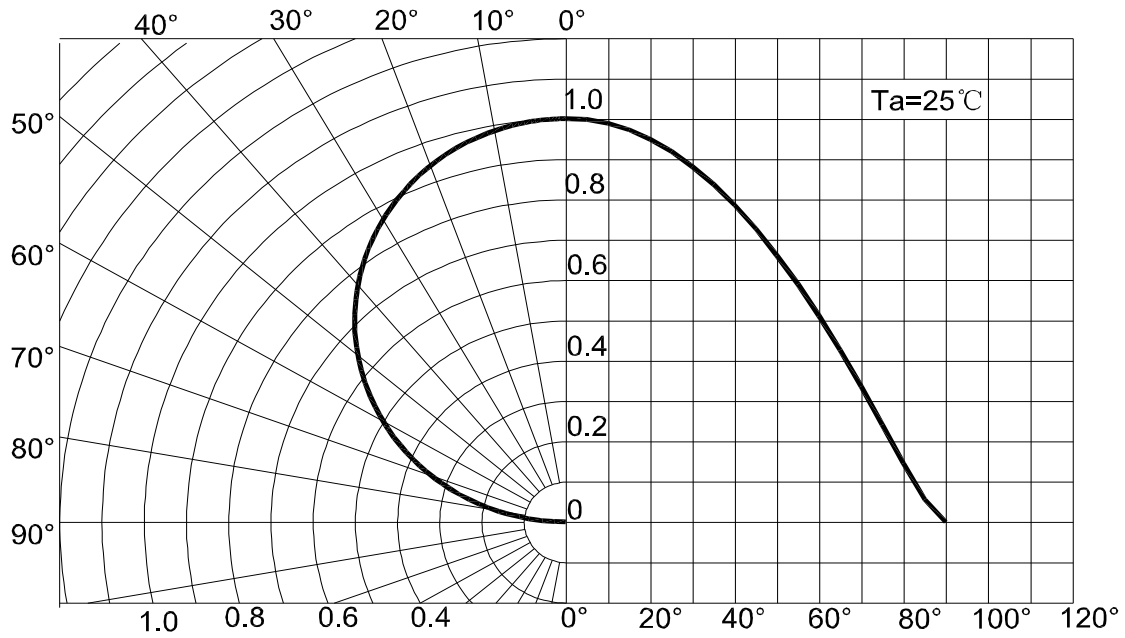

正向电流 / Forward Current

$I_f = f(V_f); T_a = 25\text{ }^\circ\text{C}$

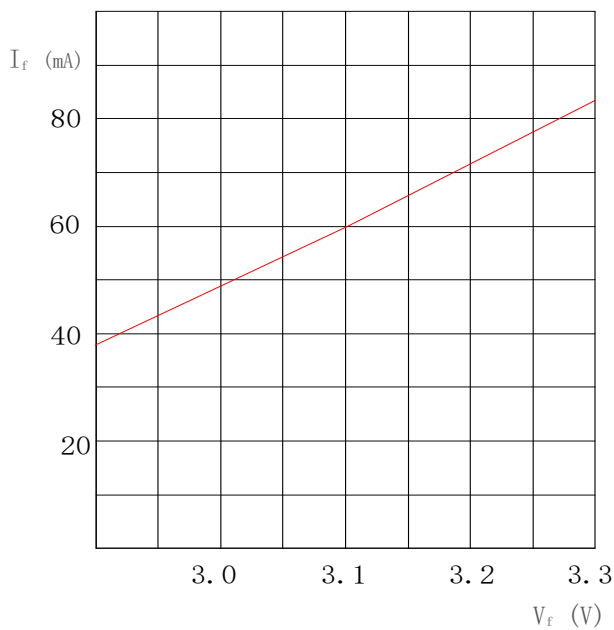

相对亮度特性曲线 / Relative Luminous Intensity

$I_v / I_v(60\text{ mA}) = f(I_f); T_a = 25\text{ }^\circ\text{C}$

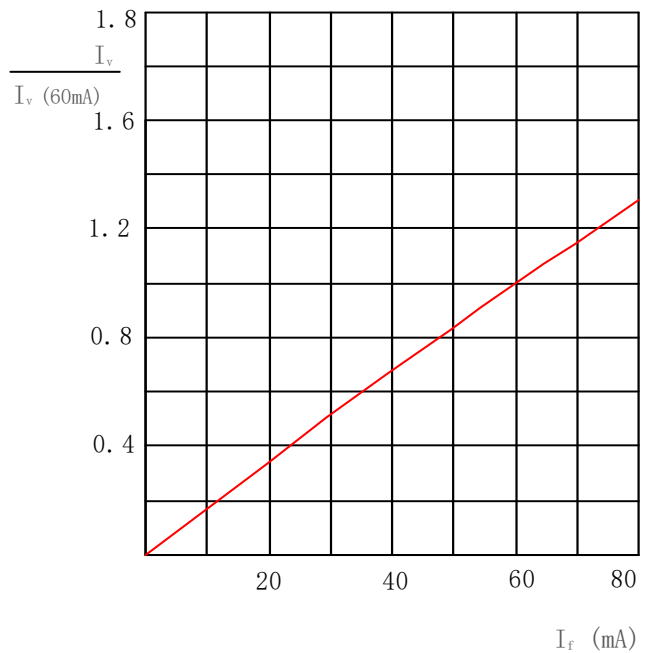

色坐标数据表/Chromaticity coordinate shift

$\Delta C_x, \Delta C_y = f(I_f); T_s = 25^\circ\text{C}$

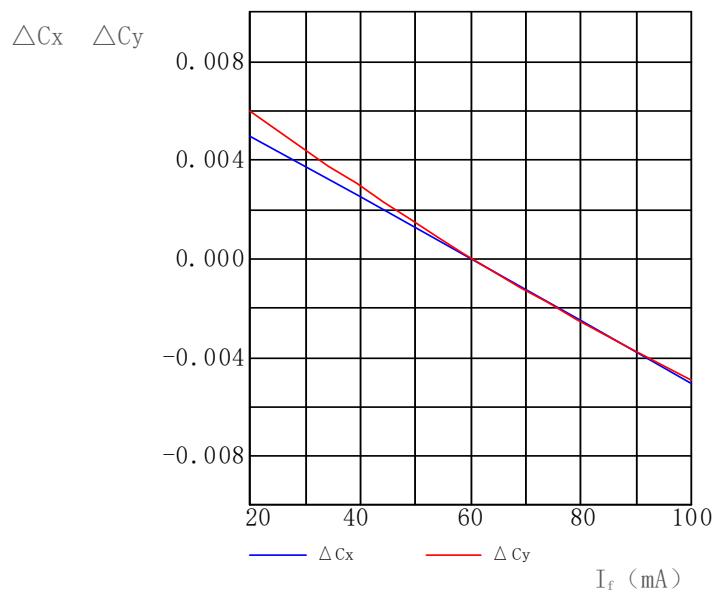

相对正向电压 / Relative Forward Voltage

$\Delta V_f = V_f - V_f(25^\circ\text{C}) = f(T_j); I_f = 60\text{ mA}$

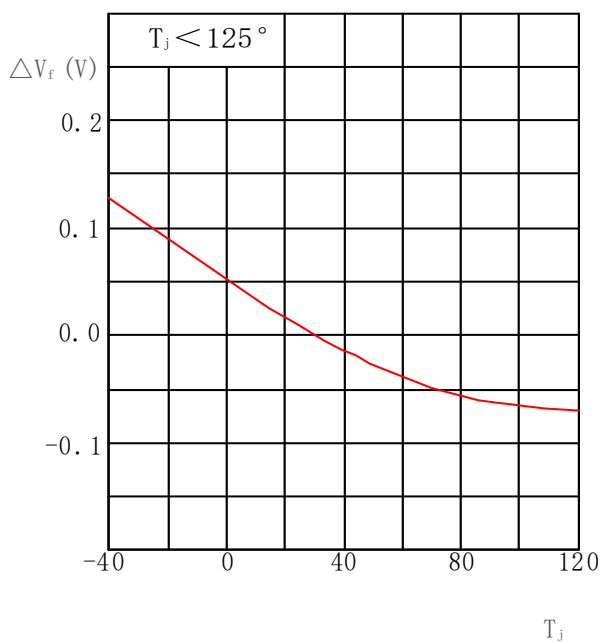

相对发光强度 / Relative Luminous Intensity

$I_v / I_v(25^\circ\text{C}) = f(T_j); I_f = 60\text{ mA}$

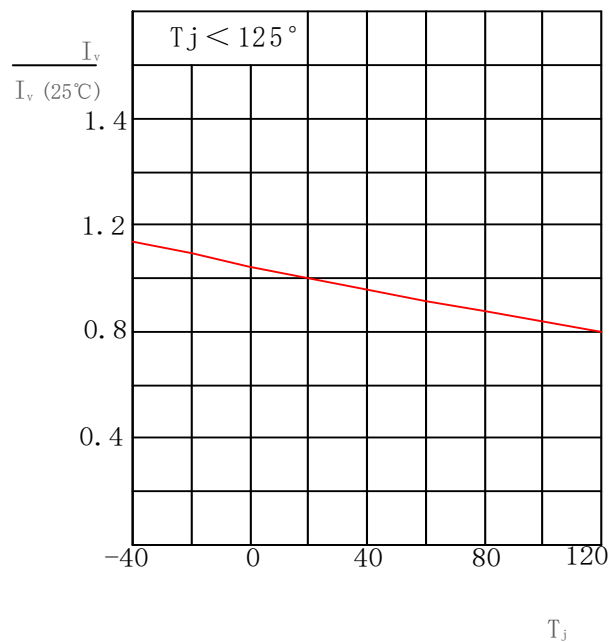

色坐标数据表/Chromaticity coordinate shift

$\Delta C_x, \Delta C_y = f(I_f); I_f = 60\text{mA}$

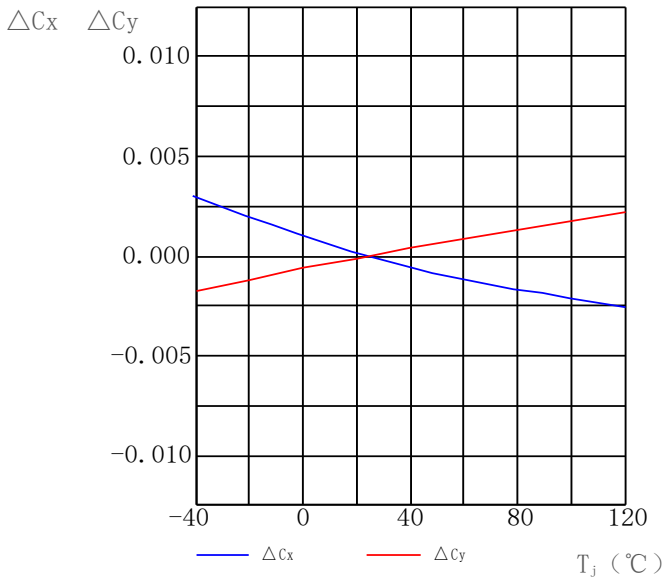

环境温度与正向电流

Ambient Temperature vs. Forward Current

$I_f = f(T_a)$

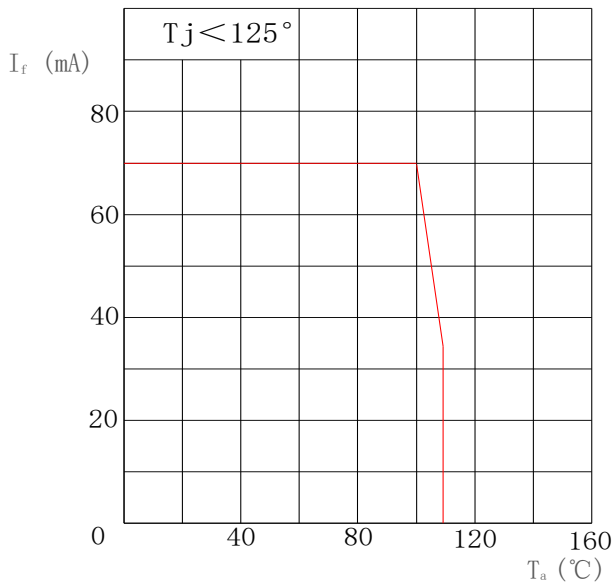

焊点温度与正向电流 / Solder Point Temperature vs. Forward Current

vs. Forward Current

$I_f = f(T_s)$

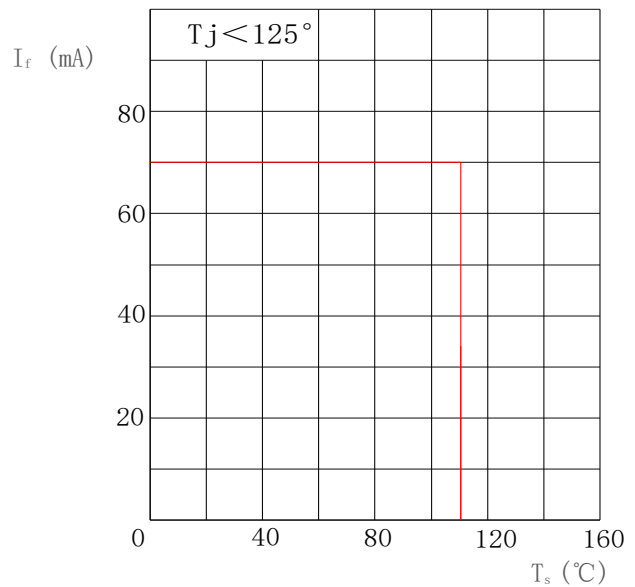

### 产品尺寸 / Package Outline

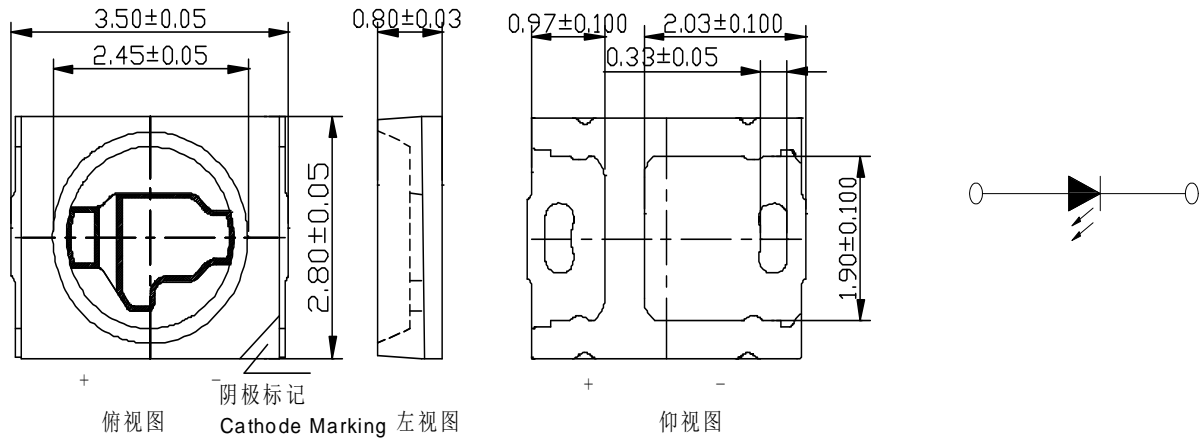

### 推荐焊盘 / Recommended Solder Pad

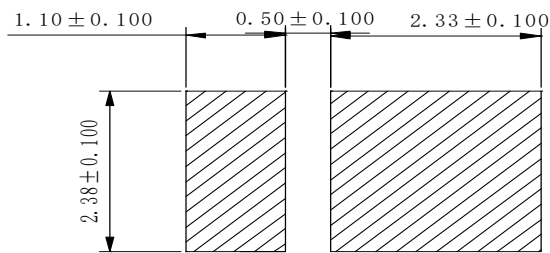

#### 注释

■ 不适合超声波清洗的封装

#### NOTE

■ Package not suitable for ultrasonic cleaning

## 回流焊要求 / Reflow Soldering Profile

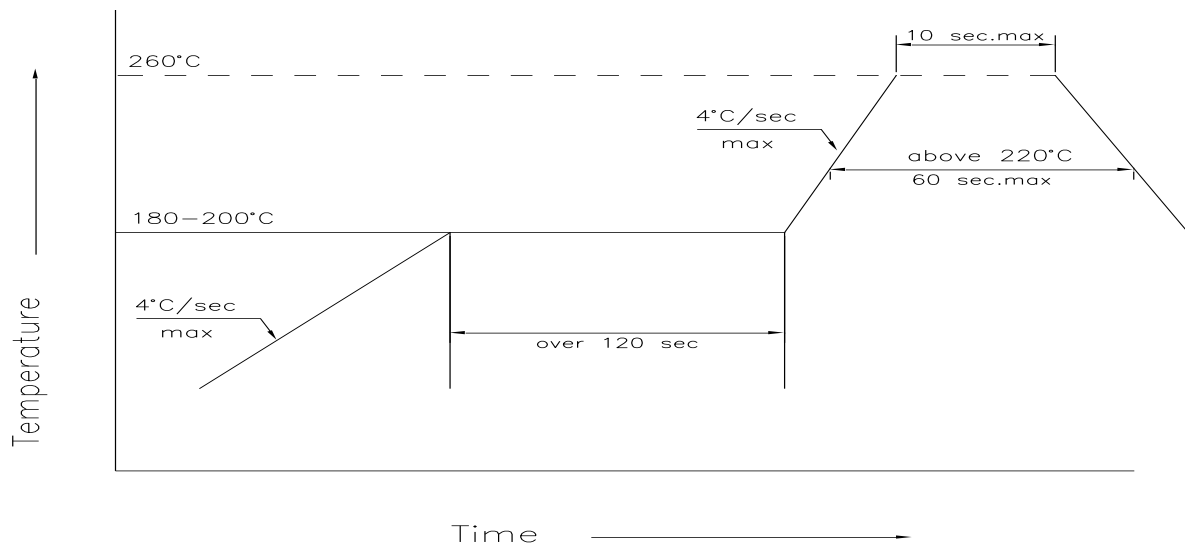

| 主要特性<br>Profile Feature  | 符号<br>Symbol | 无铅焊接<br>Pb-Free Assembly |      |      | 单位<br>Unit |
|--|--------------|--------------------------|------|------|------------|
|  |              | min.                     | rec. | max. |            |
| 预热升温速率<br>Ramp-up Rate to Preheat<br>25°C-180°C                          | -            | -                        | 2    | 3    | °C/s       |
| 时间 / Time<br>( $T_{smin}$ to $T_{smax}$ )                                | $T_s$        | 60                       | 100  | 120  | s          |
| 峰值升温速率<br>Ramp-up Rate to Peak<br>( $T_{smax}$ to $T_p$ )                | -            | -                        | 2    | 3    | °C/s       |
| 熔点温度<br>Liquidus Temperature   | $T_l$        |                          | 217  |      | °C         |
| 高于熔点温度的时间<br>Time above Liquidus<br>Temperature                          | $t_l$        | -                        | 80   | 100  | s          |
| 峰值温度 / Peak Temperature  | $T_p$        | -                        | 255  | 260  | °C         |
| 规定的峰值温度±5°C以内的时间<br>Time within 5°C of the<br>Specified Peak Temperature | $t_p$        | 10                       | 20   | 30   | s          |
| 降温速率 / Ramp-down Rate<br>( $T_p$ to 100°C)                               | -            | -                        | 3    | 6    | °C/s       |
| 时间 / Time<br>(25°C to $T_p$ )  | -            | -                        | -    | 480  | s          |



## 可靠性试验 / Reliability Test

| 试验项目<br>Test Item       | 试验方法Test<br>Method             | 试验条件Test Condition  | 周期<br>Duration       | 试验数量<br>Number Of<br>Test | 试验结果<br>Test<br>Result |
|-------------------------|--------------------------------|---|----------------------|---------------------------|------------------------|
| 光电测试<br>Test            | 产品规格书<br>Products<br>Datasheet | 25℃条件量测光电参数<br>Measurement of<br>Photoelectric parameters<br>At 25 °C   | -                    | 全部<br>ALL                 | Pass                   |
| 外观检查<br>EV              | JESD22 B-101                   | 显微镜观察<br>OM observation   | -                    | 全部<br>ALL                 | Pass                   |
| 参数验证<br>PV              | 产品规格书<br>Products<br>Datasheet | 25℃条件量测光电参数<br>Measurement of photoelectric pa-<br>rameters at 25 °C  | -                    | 75                        | 0/75                   |
| 破坏性物理分<br>析<br>DPA      | AEC-Q101-004                   | 化学开盖后, 观察外观结构<br>After Decap, OM observation  | -                    | 10                        | 0/10                   |
| 人体模式静电<br>释放<br>ESD HBM | JESD22 A-114                   | ±2000V  | 2次<br>2 times        | 30                        | 0/30                   |
| 机器模式静电<br>释放<br>ESD MM  | JESD 22-A115C                  | ±200V   | 2次<br>2 times        | 30                        | 0/30                   |
| 尺寸测量<br>PD              | JESD22 B-100                   | 参照样品种规格书<br>Per Products Datasheet  | -                    | 30                        | 0/30                   |
| 高温高湿通电<br>测试<br>WHTOL1  | JESD22 A-101                   | Ta=85° C/85% RH, 开/关各30分<br>钟, If=350mA<br>Ta=85°C 85%RH, 30min. on/30min.<br>off, If=350mA   | 1000小时<br>1000 hours | 78                        | 0/78                   |
| 功率温度循环<br>测试<br>PTC     | JESD22 A-105                   | Ta = -40°C ~ 85°C, 驻留时间10分<br>钟, 转换时间11分钟, 开/关各5分<br>钟, If=350mA<br>Ta=-40°C ~ 85°C, Dwell:<br>10min, Transition time: 11min,<br>5 min. on / 5 min. off, If=350mA | 1000循环<br>1000 cyc   | 78                        | 0/78                   |
| 高温寿命测试<br>HTOL          | JESD22-A108                    | Ta = 85° C, If=350mA  | 1000小时<br>1000 hours | 78                        | 0/78                   |

## 可靠性试验 / Reliability Test

|             |  |   |   |    |          |
|-------------|--|---|---|----|----------|
| 热阻测试<br>TR  | JEDEC<br>JESD51-50<br>JESD51-51<br>JESD51-52 | 需使用不同导热材质分层测试<br>Need to use different<br>thermal conductivity<br>material layer test | - | 10 | 16       |
| 金线拉力<br>WBP | MIL-STD-750-2<br>Method 2037                 | 参照MIL-STD-750-2Method 2037<br>Per MIL-STD-750-2Method 2037                            | - | 15 | Ppk>1.67 |
| 金球推力<br>WBS | AEC Q101-003                                 | 参照AEC Q101-003<br>Per AEC Q101-003  | - | 15 | Ppk>1.67 |
| 晶片推力<br>DS  | MIL-STD-750-2<br>Method 2017                 | 参照MIL-STD-750-2Method 2017<br>Per MIL-STD-750-2Method 2017                            | - | 15 | Ppk>1.67 |

## 接受标准 / Acceptance Criteria

|  |   |
|--|---|
| 正向电压<br>Forward Voltage                    | Vf变化 $\leq$ +/-10%<br>VF shift% $\leq$ +/- 10% from initial value   |
| 光通量<br>Luminous Flux                       | LM光通量变化 $\leq$ +/-20%，备注：某些应用环境 $\leq$ +/-30%，某些特定应用（如内饰） $\leq$ +/-50%<br>LM shift $\leq$ %+/- 20% from initial value, Note. +/- 30% may be acceptable for some application. +/- 50% may be acceptable only for some application (e.g., interior). |
| 色坐标Cx & Cy<br>Colour coordinates Cx and Cy | Cx & Cy 变化 $\leq$ +/-0.01, 备注：对于硫化氢和混合气体腐蚀的变化 $\leq$ +/-0.02（如内饰）<br>Cx & Cy shift $\leq$ +/-0.01, Note: +/- 0.02 may be acceptable for H2S & FMG for some application (e.g., interior).  |
| 外观<br>Visual                               | 无迁移，腐蚀，分层等<br>No migration, corrosion, delamination, other  |

## 卷带与卷盘 / Tape and Reel

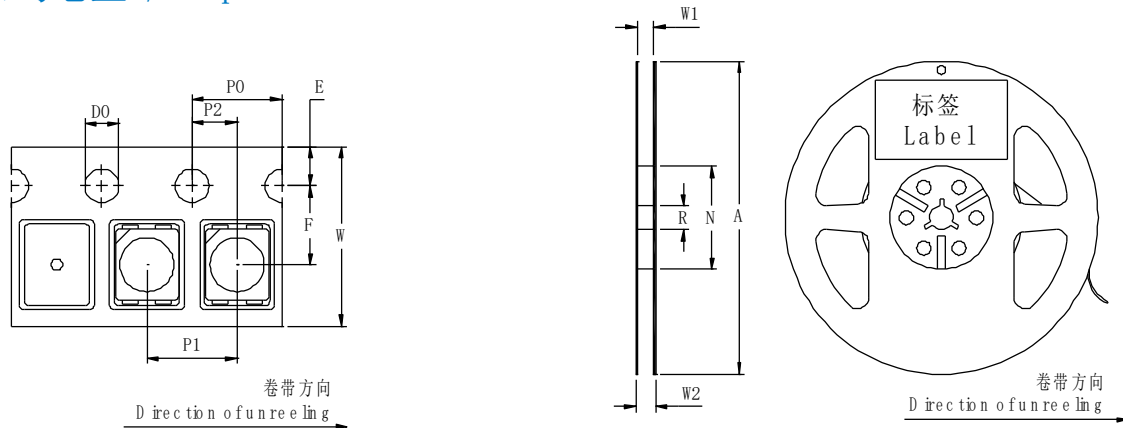

前端空带： 最小400 mm；尾端空带： 最小160 mm；尺寸符合： IEC 60286-3, EIA 481-D标准

Leader: min. 400 mm; Trailer: min. 160 mm; Requirement acc. to IEC 60286-3, EIA 481-D

## 卷带尺寸 / Tape Dimensions (mm)

| W     | P0    | P1    | P2     | D0        | E        | F         |
|-------|-------|-------|--------|-----------|----------|-----------|
| 8±0.1 | 4±0.1 | 4±0.1 | 2±0.05 | 1.50±0.05 | 1.75±0.1 | 3.50±0.05 |

## 卷盘尺寸 / Reel Dimensions (mm)

| A         | W1      | W2      | N        | R        |
|-----------|---------|---------|----------|----------|
| 178.0±0.2 | 8.0±0.5 | 8.0±0.5 | 60.0±0.4 | 13.5±0.3 |

## 数量 (颗/卷) / Quantity (pcs/reel)

4000

条形码标签 / Barcode-Product-Label (BPL)

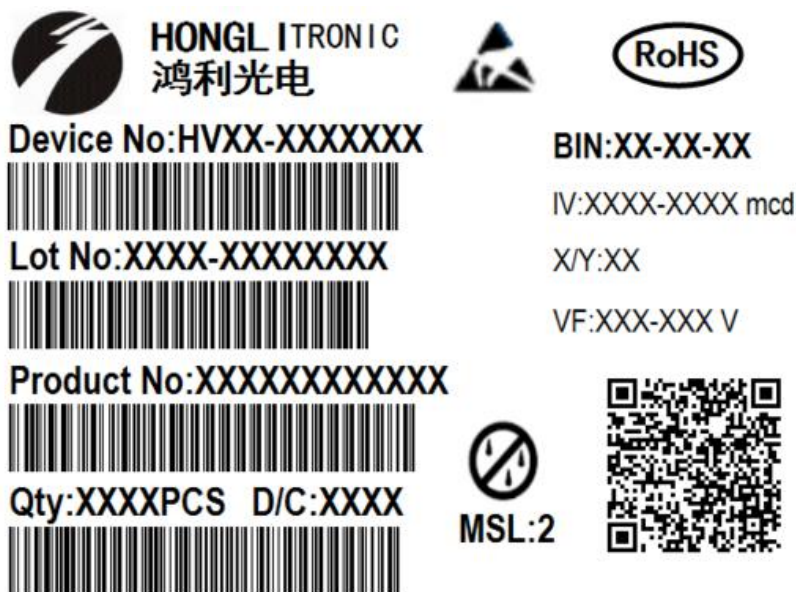

包装材料及过程 / Dry Packing Process and Materials

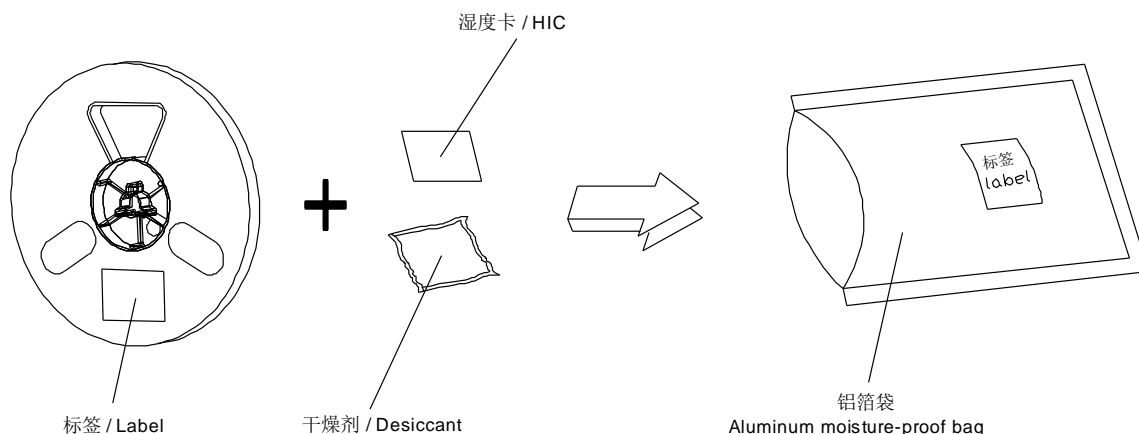

备注

产品包装在一个干燥的铝箔袋里，同时内附有干燥剂和湿度卡。  
对于干燥包装，您可以从网络或JEDEC标准里获取。

NOTE

Moisture-sensitive product is packed in a dry bag containing desiccant and HIC (humidity indicator card).  
Regarding dry pack you may find further information in the internet or JEDEC.

## 出货包装及材料 / Transportation Packing and Materials

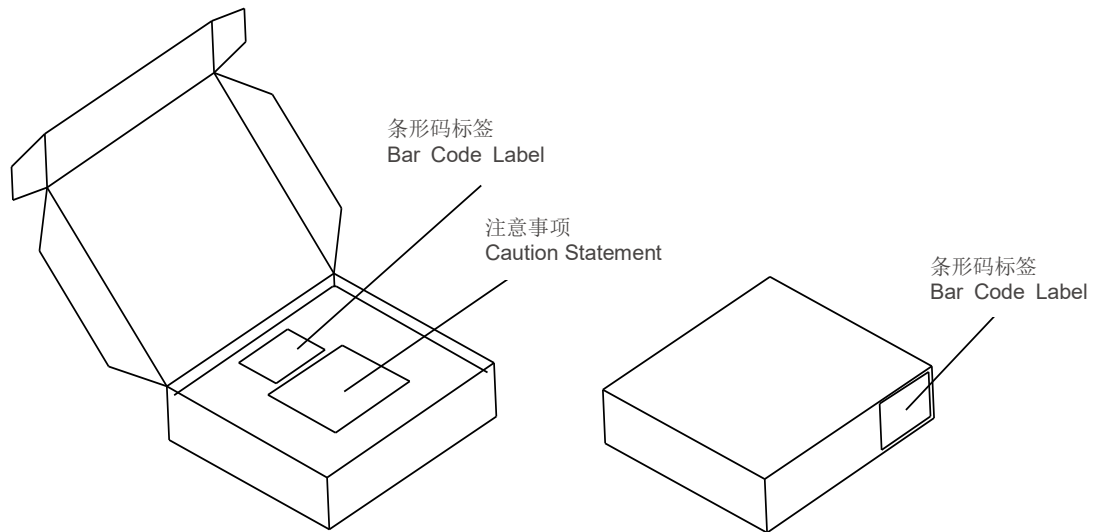

## 出货箱尺寸 / Dimensions of Transportation Box (mm)

| 宽度 / Width | 长度 / Length | 高度 / Height |
|------------|-------------|-------------|
| 256±5      | 223±5       | 62±5        |
| 256±5      | 223±5       | 124±5       |

## 注释

**典型值：** 每个产品的实际值可能与这些统计出的典型值不同。

**公差：** 除非图纸中有说明，公差默认为  $\pm 0.1$  mm。

**正向电压：** 正向电压是在8ms脉冲电流并且内部在线性为 $\pm 0.05$ V和一个 $\pm 0.1$ V的外在不确定性（按照GUM K=3因子）来进行测试的。

**波长：** 波长是在25ms脉冲电流并且内部在线性为 $\pm 0.5$ nm和一个 $\pm 1$ nm的外在不确定性（按照GUM K=3因子）来进行测试的。

**亮度：** 亮度是在25ms脉冲电流并且内部在线性为 $\pm 8\%$ 和一个 $\pm 11\%$ 的外在不确定性（按照GUM K=3因子）来进行测试的。

**特殊声明：** 本版本最终解释权归属鸿利智汇，当中英文意思发生歧义时，以中文为准。

## Glossary

**Typical Values:** Actual values of each product may differ from these statistical values .

**Tolerance of Measure:** Unless otherwise noted in drawing, tolerances are specified with +/-0.1mm.

**Forward Voltage:** The forward voltage is measured during a current pulse of typically 8 ms, with an internal reproducibility of  $\pm 0.05$  V and an expanded uncertainty of  $\pm 0.1$  V (acc. to GUM with a coverage factor of  $k = 3$ ).

**Wavelength:** The wavelength is measured at a current pulse of typically 25 ms, with an internal reproducibility of  $\pm 0.5$  nm and an expanded uncertainty of  $\pm 1$  nm (acc. to GUM with a coverage factor of  $k = 3$ ).

**Brightness:** Brightness values are measured during a current pulse of typically 25 ms, with an internal reproducibility of  $\pm 8\%$  and an expanded uncertainty of  $\pm 11\%$  (acc. to GUM with a coverage factor of  $k = 3$ ).

**Special Statement:** The final interpretation of this specification shall be vested in Hongli-tronic, in the case of ambiguity, the Chinese version shall prevail.

## X-ON Electronics

Largest Supplier of Electrical and Electronic Components

*Click to view similar products for [Standard LEDs - SMD category](#):*

*Click to view products by [HONGLITRONIC manufacturer](#):*

Other Similar products are found below :

[LTST-C190KYKT](#) [LTST-C19GD2WT](#) [LTW-170ZDC](#) [LTW-M140SZS40](#) [LTW-M140ZVS](#) [598-8110-100F](#) [598-8610-202F](#) [91-21SUBCS400-A6TR7](#) [AAAF5060QBFSEEZGS](#) [APT1608QGW](#) [99-213/R6C-AR2T1B/2C](#) [SML-LX0606SISUGC/A](#) [SML-LXR851SIUPGUBC](#) [LT1ED53A](#) [APFA3010SURKCGKQBDC](#) [APHK1608VGCA](#) [APT2012QGW](#) [LTST-008BGEW](#) [LTW-010DCG](#) [LTW-020ZDCG](#) [LTW-21TS5](#) [LTW-220DS5](#) [598-8330-117F](#) [65-21SYGC/S530-E3/TR8](#) [CMDA20AYAA7D1S](#) [95-21SURCS530-A3TR10](#) [598-8070-100F](#) [598-8140-100F](#) [598-8610-200F](#) [SML-LXR851SGSIC-TR](#) [SML-512PWT86A](#) [EASV3015RGYA0](#) [95-21UYC-S530-A5-TR7](#) [LTST-C190KFKT-5A](#) [LTST-C194TBKT-5A](#) [CLX6E-FKC-CH1M1D1BB7C3D3](#) [SML-LXL0805USBC-TR](#) [SML-LX2835SYSUGCTR](#) [LTW-M670ZVS-M5](#) [APA2106ZGC/G](#) [CLMXB-FKA-CbcfghjnpACBB79463](#) [KPTD-2012LVVBC-D](#) [VFA1101W-5AY3B2-TR](#) [LCB P473-P2R2-3J7L-1-Z](#) [91-21VGC/S556/S68/TR10/S370](#) [LW A67C-S2U1-FK0KM0](#) [LW A673-P1S1-FK0PM0](#) [BL-HE1G033B-TRB](#) [5988B90107F](#) [EL-19-21SURC/S530-A6](#)