

# HVCW-3433EQXA

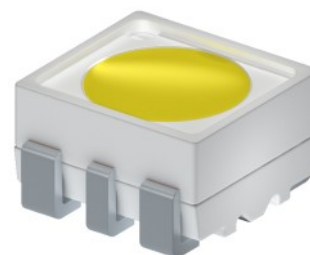

## 3433 PLCC6 系列产品 / Products Series

具有高发光效率、高一致性、高稳定性、高可靠性，主要用于汽车应用

High luminous efficiency, consistency, stability and reliability, it is mainly used in automobile applications.

### 特征

- 外观：白色PPA塑料，荧光硅胶封装
- 50% I<sub>v</sub> 视角：120°
- 颜色：Cx=0.33,Cy=0.33 ( CIE1931 )
- 资格：通过了AEC-Q102 & IEC 60810可靠性测试
- 潮湿敏感等级-2

### Features

- Package: Colored diffused silicone in white PPA cup
- Viewing angle at 50% I<sub>v</sub>: 120°
- Color: Cx=0.33,Cy=0.33 ( acc.to CIE1931 )
- Qualifications: Passed reliability test per AEC-Q102 & IEC 60810 requirement
- MSL-2

### 应用

- 信号灯
- 汽车内外部照明应用

### Applications

- Signaling
- Interior and exterior lighting for automotive

## 订购信息 / Ordering Information

型号 Type	发光强度 Luminous Intensity I <sub>v</sub> @ I <sub>f</sub> =140mA	订单编号 Ordering Code
HVCW-3433EQXA-XXXX - XXXX - XX                                             亮度档            色度坐标            电压档 Brightness      Chromaticity      Forward Coordinate          Voltage	7.10 - 22.40 cd	XXXXXX

## 备注

## ■ 亮度档

单个最小包装只装有同一个亮度档次的产品，具体分档信息请见第4页

例如：HVCW-3433EQXA-EAGA-XXXX-XX，单个卷盘中的产品只有EA、EB、FA、FB、GA中的某一档

## ■ 色度坐标档

单个最小包装只装有同一个色度坐标档次的产品，具体分档信息请见第5页

例如：HVCW-3433EQXA-XXXX-JKQL-XX，单个卷盘中的产品只有JK、JL...QK、QL或FK0、FL0、GK0、GL0、HK0、HL0……PN0中的某一档

## ■ 正向电压档

单个最小包装只装有同一个正向电压档次的产品，具体分档信息请见第4页

例如：HVCW-3433EQXA-XXXX-XXXX-47，单个卷盘中的产品只有4、5、6、7中的某一档

## Note

## ■ Brightness Grouping

Only one brightness group will be packed in each reel. Please refer to page #4 for details.

E.g.: HVCW-3433EQXA-EAGA-XXXX-XX, means only one bin of EA, EB, FA, FB or GA is in each reel.

## ■ Chromaticity Coordinate Groups

Only one Chromaticity Coordinate group will be packed in each reel. Please refer to page #5 for details.

E.g.: HVCW-3433EQXA-XXXX-JKQL-XX, means only one bin of JK, JL...QK, QL or FK0, FL0, GK0, GL0, HK0, HL0……PN0 is in each reel.

## ■ Forward Voltage Groups

Only one forward voltage group will be packed in each reel. Please refer to page #4 for details.

E.g.: HVCW-3433EQXA-XXXX-XXXX-47, means only one bin of 4, 5, 6 or 7 is in each

## 极限参数 / Maximum Ratings

参数 Parameters	符号 Symbol	数值 Rating	单位 Unit
结温 / Junction Temperature	$T_j$	125	°C
正向电流 / Forward Current ( $T_s=25^\circ\text{C}$ )	$I_f$	240	mA
峰值正向电流 Peak Forward Current ( $t \leq 10\mu\text{s}$ ; $D=0.005$ ; $T_s=25^\circ\text{C}$ )	$I_{fp}$	750	mA
反向电压 / Reverse Voltage ( $T_s=25^\circ\text{C}$ )	$V_r$	不可施加反向电压 / not designed for reverse operation	V
抗静电能力 Electrostatic Discharge (HBM)	$V_{ESD}$	2000	V
操作温度 / Operating Temperature	$T_{opr}$	-40 ~ +110	°C
储存温度 / Storage Temperature	$T_{stg}$	-40 ~ +110	°C

特性 / Characteristics ( $T_s = 25^\circ\text{C}$ ;  $I_f = 140\text{ mA}$ )

参数 Parameters		符号 Symbol	数值 Rating	单位 Unit
色坐标 / Chromaticity coordinates acc. to CIE 1931	typ.	$C_x$	0.33	nm
		$C_y$	0.33	
50 % $I_v$ 下的视角 / Viewing Angle at 50 % $I_v$	typ.	$2\phi$	120	°
	min.	$V_f$	2.90	V
	typ.	$V_f$	3.30	V
正向电压 / Forward Voltage	max	$V_f$	4.10	V
	typ.			
反向电流 / Reverse Current ( $V_R=12\text{V}$ )	typ.	$I_r$	不可施加反向 电压 / not designed for reverse operation	uA
	max.	$I_r$		uA
实际热阻值 (PN结-环境) / Real Thermal Resistance (Junction / Ambient )	max.	$R_{th\ JA_{real}}$	40	K/W
实际热阻值 (PN结-焊点) / Real Thermal Resistance (Junction / Solder Point)	max.	$R_{th\ JS_{real}}$	34	K/W

亮度分档 / Brightness Grouping ( $T_s = 25\text{ }^\circ\text{C}$ ;  $I_f = 140\text{ mA}$ )

档次 Grouping	发光强度 Luminous Intensity $I_v$ ( min. )	发光强度 Luminous Intensity $I_v$ ( max. )	光通量 Luminous Flux $\Phi_v$ ( typ. )
EA	7.10 cd	9.00 cd	24.20 lm
EB	9.00 cd	11.20 cd	30.30 lm
FA	11.20 cd	14.00 cd	37.80 lm
FB	14.00 cd	18.00 cd	45.80 lm
GA	18.00 cd	22.40 cd	54.20 lm

正向电压分档 / Forward Voltage Grouping ( $T_s = 25\text{ }^\circ\text{C}$ ;  $I_f = 140\text{ mA}$ )

档次 Grouping	正向电压 Forward Voltage $V_f$ ( min. )	正向电压 Forward Voltage $V_f$ ( max. )
4	2.90 V	3.20 V
5	3.20 V	3.50 V
6	3.50 V	3.80 V
7	3.80 V	4.10 V

颜色色度分档/Colour Chromaticity Groups 1 ( $T_s = 25\text{ }^\circ\text{C}$ ;  $I_f = 140\text{ mA}$ )

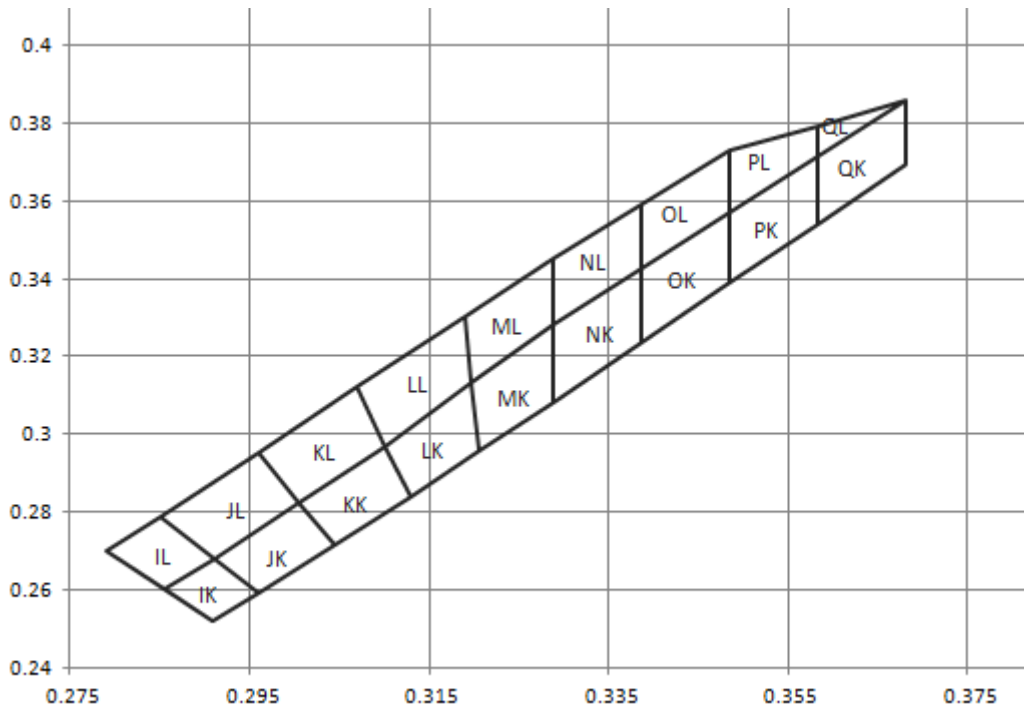

	X	Y	X	Y	X	Y	X	Y
JK	0.2910	0.2680	0.3100	0.2970	0.3288	0.3081	0.3484	0.3388
	0.2960	0.2590	LK	0.3130	0.2840	NK	0.3288	0.3282
	0.3005	0.2825	0.3197	0.3131	0.3386	0.3235	PK	0.3484
	0.3045	0.2715	0.3205	0.2956	0.3386	0.3426	0.3582	0.3542
JL	0.2850	0.2790	0.3070	0.3120	0.3288	0.3282	0.3484	0.3571
	0.2910	0.2680	LL	0.3100	0.2970	NL	0.3288	0.3453
	0.2960	0.2955	0.3189	0.3302	0.3386	0.3426	PL	0.3484
	0.3005	0.2825	0.3197	0.3131	0.3386	0.3591	0.3582	0.3715
KK	0.3005	0.2825	0.3197	0.3131	0.3386	0.3235	0.3582	0.3792
	0.3045	0.2715	MK	0.3205	0.2956	OK	0.3386	0.3426
	0.3100	0.2970	0.3288	0.3081	0.3484	0.3388	QK	0.3582
	0.3130	0.2840	0.3288	0.3282	0.3484	0.3571	0.3680	0.3715
KL	0.2960	0.2955	0.3189	0.3302	0.3386	0.3426	0.3680	0.3859
	0.3005	0.2825	ML	0.3197	0.3131	OL	0.3386	0.3571
	0.3070	0.3120	0.3288	0.3282	0.3484	0.3571	QL	0.3582
	0.3100	0.2970	0.3288	0.3452	0.3484	0.3730	0.3680	0.3859

颜色色度分档/Colour Chromaticity Groups 2 ( $T_s = 25\text{ }^\circ\text{C}$ ;  $I_f = 140\text{ mA}$ )

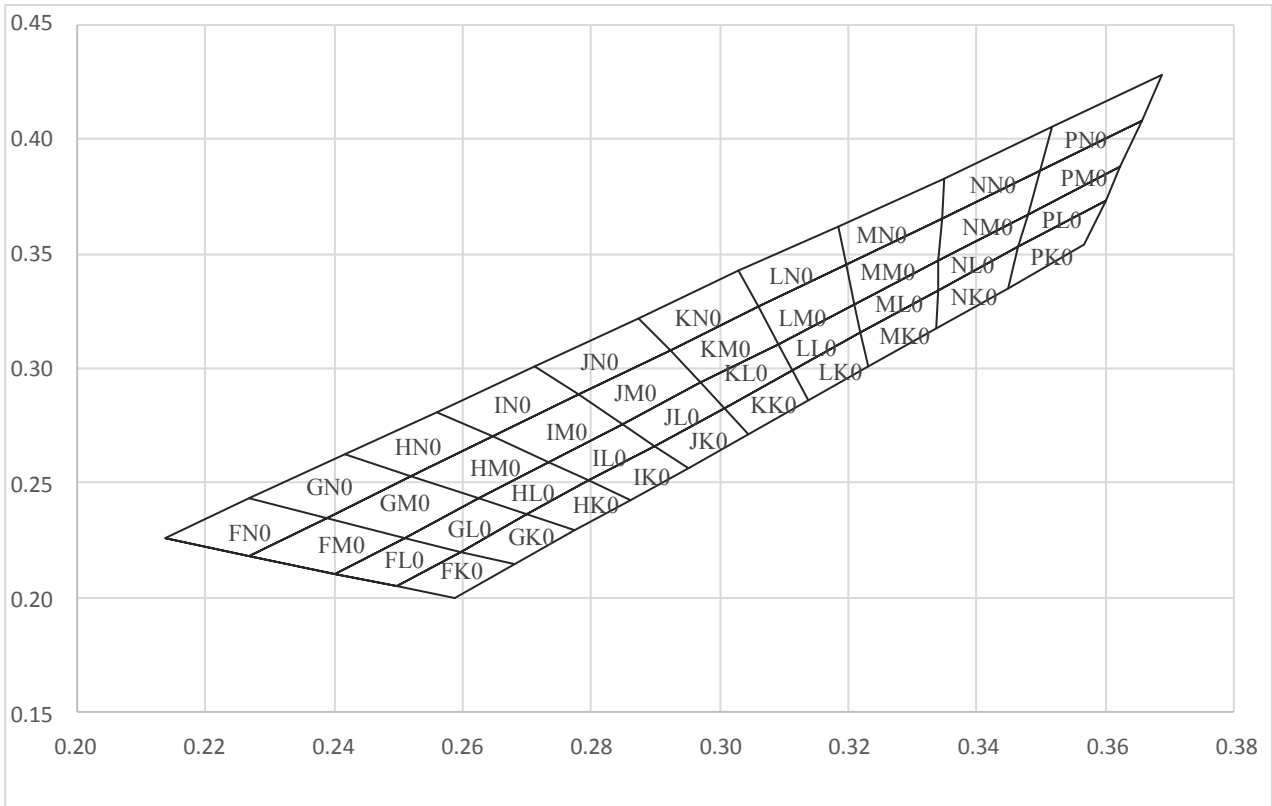

	X	Y		X	Y		X	Y
	0.2498	0.2053		0.2700	0.2361		0.2898	0.2664
FK0	0.2597	0.2204	HK0	0.2797	0.2509	JK0	0.3007	0.2830
	0.2682	0.2146		0.2861	0.2427		0.3045	0.2717
	0.2589	0.2000		0.2775	0.2292		0.2950	0.2568
	0.2402	0.2108		0.2624	0.2431		0.2848	0.2757
FL0	0.2509	0.2264	HLO	0.2733	0.2590	JLO	0.2971	0.2935
	0.2597	0.2204		0.2797	0.2509		0.3007	0.2830
	0.2498	0.2053		0.2700	0.2361		0.2898	0.2664
	0.2269	0.2185		0.2520	0.2527		0.2780	0.2883
FM0	0.2388	0.2348	HM0	0.2646	0.2700	JM0	0.2922	0.3077
	0.2509	0.2264		0.2733	0.2590		0.2971	0.2935
	0.2402	0.2108		0.2624	0.2431		0.2848	0.2757
	0.2136	0.2262		0.2416	0.2623		0.2712	0.3009
FNO	0.2267	0.2432	HNO	0.2559	0.2810	JNO	0.2873	0.3219
	0.2388	0.2348		0.2646	0.2700		0.2922	0.3077
	0.2269	0.2185		0.2520	0.2527		0.2780	0.2883

HVCW-3433EQXA

	0.2597	0.2204		0.2797	0.2509		0.3007	0.2830
GK0	0.2700	0.2361	IK0	0.2898	0.2664	KK0	0.3113	0.2992
	0.2775	0.2292		0.2950	0.2568		0.3138	0.2862
	0.2682	0.2146		0.2861	0.2427		0.3045	0.2717
	0.2509	0.2264		0.2733	0.2590		0.2971	0.2935
GL0	0.2624	0.2431	ILO	0.2848	0.2757	KLO	0.3090	0.3108
	0.2700	0.2361		0.2898	0.2664		0.3113	0.2992
	0.2597	0.2204		0.2797	0.2509		0.3007	0.2830
	0.2388	0.2348		0.2464	0.2700		0.2922	0.3077
GM0	0.2520	0.2527	IMO	0.2780	0.2883	KM0	0.3060	0.3266
	0.2624	0.2431		0.2848	0.2757		0.3090	0.3108
	0.2509	0.2264		0.2733	0.2590		0.2971	0.2935
	0.2267	0.2432		0.2559	0.2810		0.2873	0.3219
GN0	0.2416	0.2623	INO	0.2712	0.3009	KNO	0.3030	0.3424
	0.2520	0.2527		0.2780	0.2883		0.3060	0.3266
	0.2388	0.2348		0.2464	0.2700		0.2922	0.3077
	0.3113	0.2992		0.3196	0.3451		0.3465	0.3530
LK0	0.3219	0.3154	MM0	0.3345	0.3654	PK0	0.3599	0.3735
	0.3231	0.3008		0.3341	0.3472		0.3567	0.3535
	0.3138	0.2862		0.3209	0.3281		0.3447	0.3347
	0.3090	0.3108		0.3183	0.3621		0.3479	0.3673
LL0	0.3209	0.3281	MNO	0.3349	0.3830	PL0	0.3623	0.3882
	0.3219	0.3154		0.3345	0.3654		0.3599	0.3735
	0.3113	0.2992		0.3196	0.3451		0.3465	0.3530
	0.3060	0.3266		0.3339	0.3336		0.3498	0.3863
LM0	0.3196	0.3451	NK0	0.3465	0.3530	PM0	0.3655	0.4079
	0.3209	0.3281		0.3447	0.3347		0.3623	0.3882
	0.3090	0.3108		0.3335	0.3172		0.3479	0.3673
	0.3030	0.3424		0.3341	0.3472		0.3517	0.4053
LN0	0.3183	0.3621	NLO	0.3479	0.3673	PN0	0.3687	0.4276
	0.3196	0.3451		0.3465	0.3530		0.3655	0.4079
	0.3060	0.3266		0.3339	0.3336		0.3498	0.3863
	0.3219	0.3154		0.3345	0.3654			
MK0	0.3339	0.3336	NM0	0.3498	0.3863			
	0.3335	0.3172		0.3479	0.3673			
	0.3231	0.3008		0.3341	0.3472			
	0.3209	0.3281		0.3349	0.3830			
MLO	0.3341	0.3472	NN0	0.3517	0.4053			
	0.3339	0.3336		0.3498	0.3863			
	0.3219	0.3154		0.3345	0.3654			

## 标签信息 / Information on Label

例 / E.g.: EB-JK-4

亮度档 / Brightness	颜色 / Color	正向电压 / Forward Voltage
EB	JK	4

相对发射光谱 -  $V(\lambda)$  = 标准人眼视觉曲线

Relative Spectral Emission -  $V(\lambda)$  = Standard Eye Response Curve

$I_{rel} = f(\lambda)$ ;  $T_s = 25\text{ }^\circ\text{C}$ ;  $I_f = 140\text{ mA}$

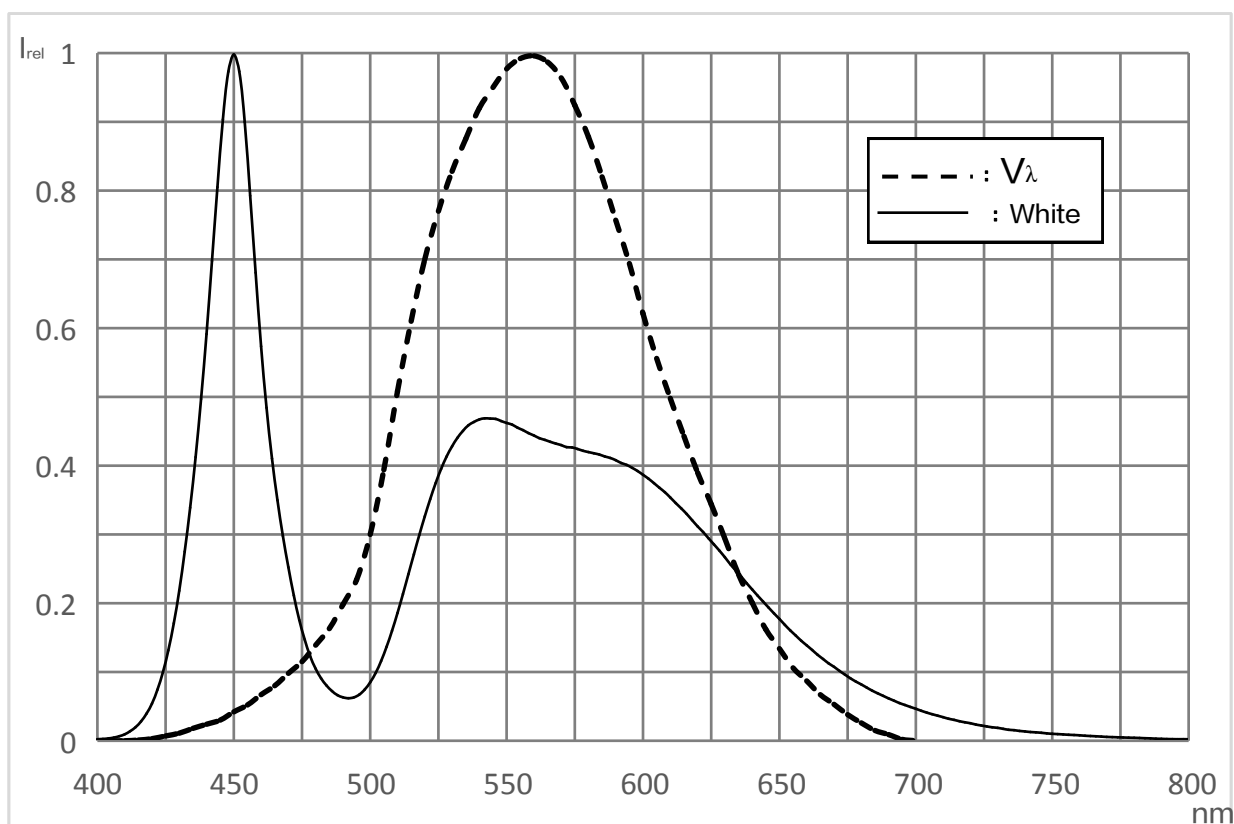



辐射特性 / Radiation Characteristics

$I_{rel} = f(\phi)$ ;  $T_s = 25^\circ\text{C}$

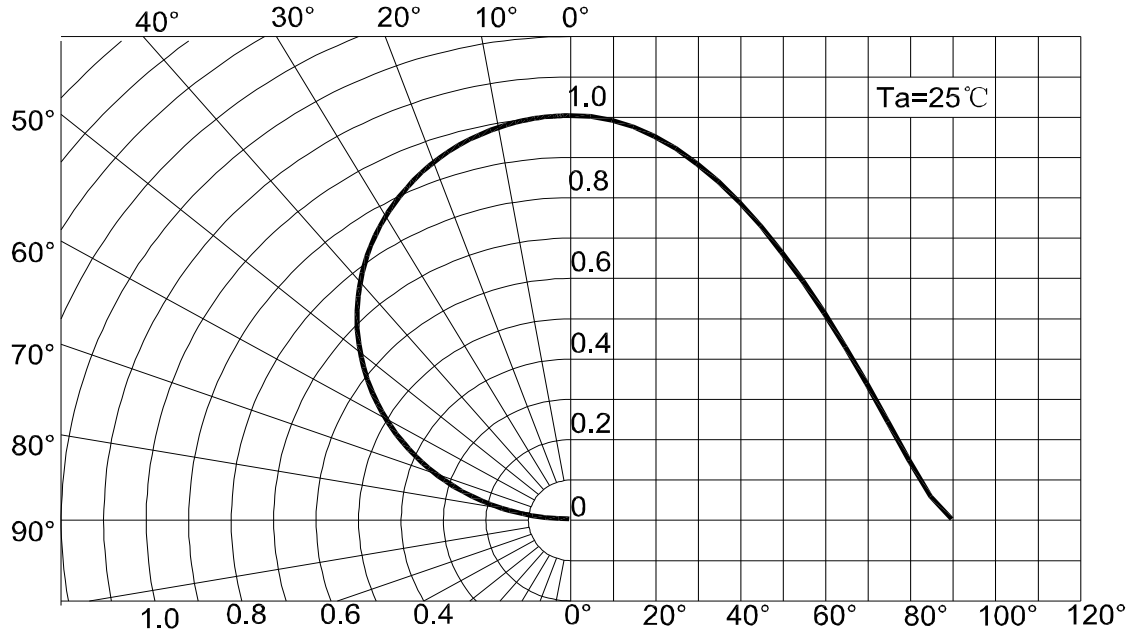

正向电流 / Forward Current

$I_f = f(V_f)$ ;  $T_a = 25^\circ\text{C}$

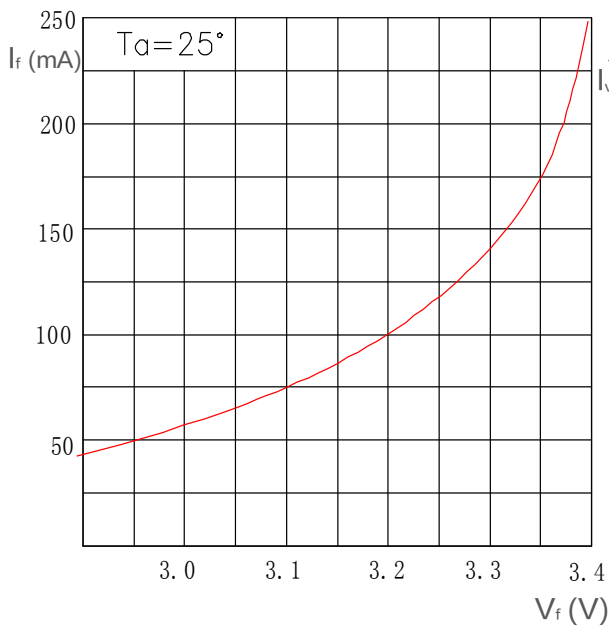

相对亮度特性曲线 / Relative Luminous Intensity

$I_v/I_v(140\text{ mA}) = f(I_f)$ ;  $T_a = 25^\circ\text{C}$

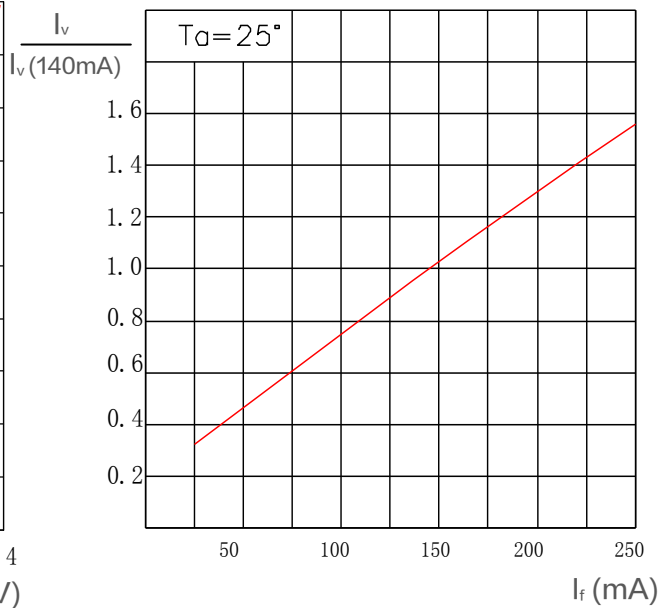

色坐标数据表/Chromaticity coordinate shift

$\Delta Cx, \Delta Cy = f(I_f); T_s = 25^\circ C$

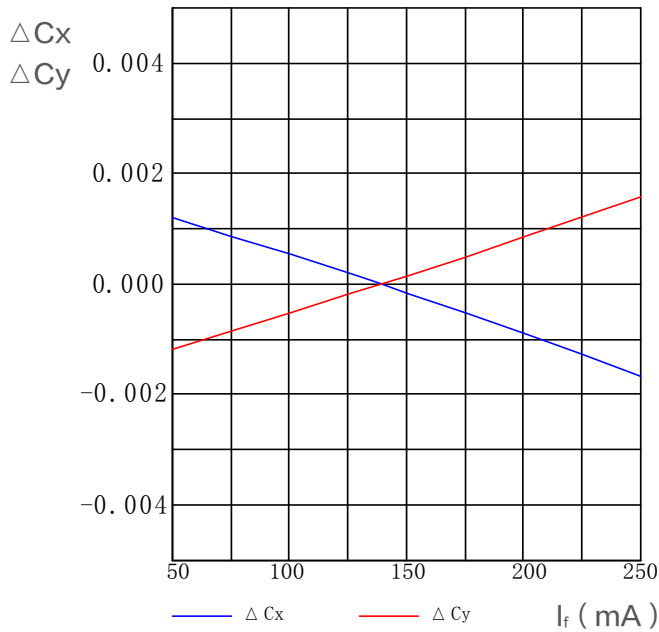

相对正向电压 / Relative Forward Voltage

$\Delta V_f = V_f - V_f(25^\circ C) = f(T_j); I_f = 140\text{ mA}$

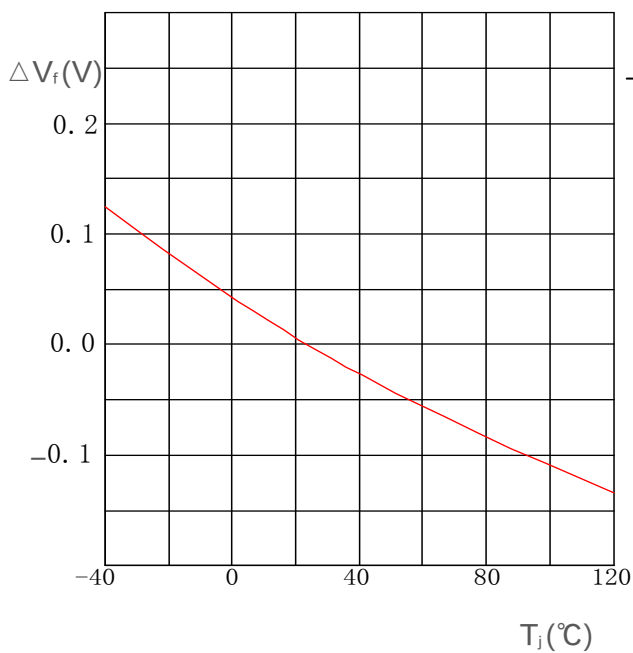

相对发光强度 / Relative Luminous Intensity

$I_v / I_v(25^\circ C) = f(T_j); I_f = 140\text{ mA}$

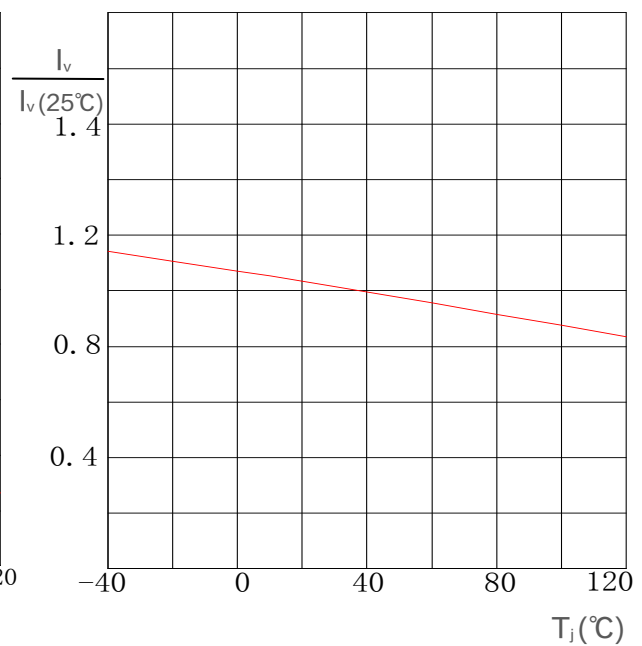

色坐标数据表/Chromaticity coordinate shift

$\Delta Cx, \Delta Cy = f(I_f); I_f = 140\text{mA}$

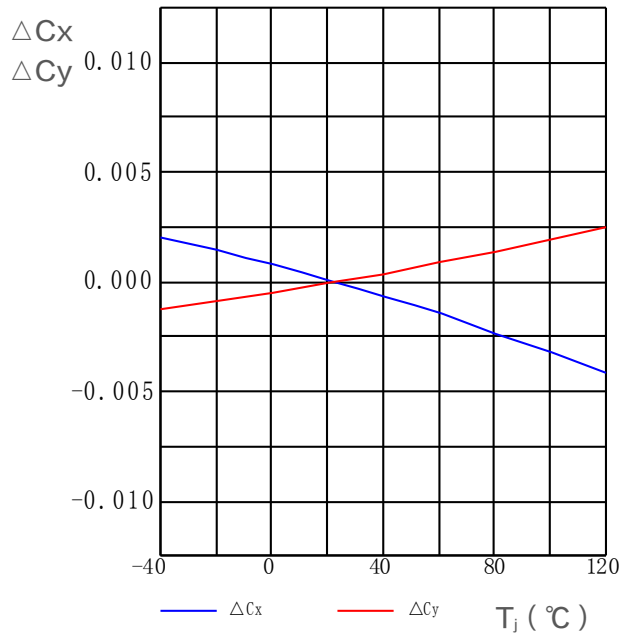

焊点温度与正向电流 / Solder Point Temperature vs. Forward Current

$I_f = f(T_s)$

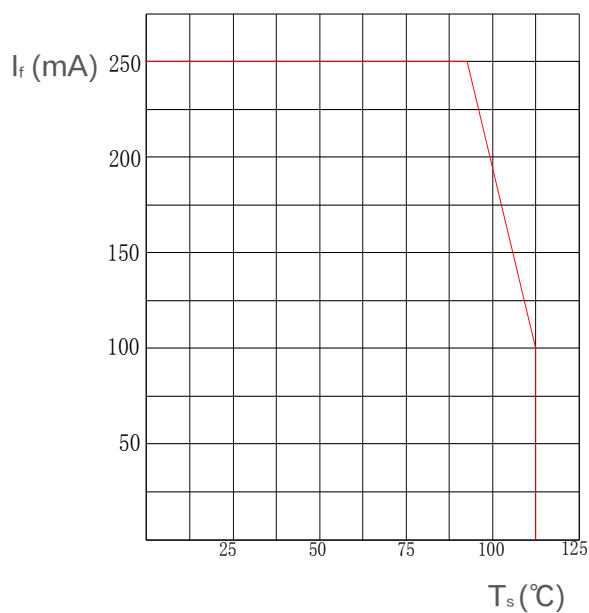

## 产品尺寸 / Package Outline

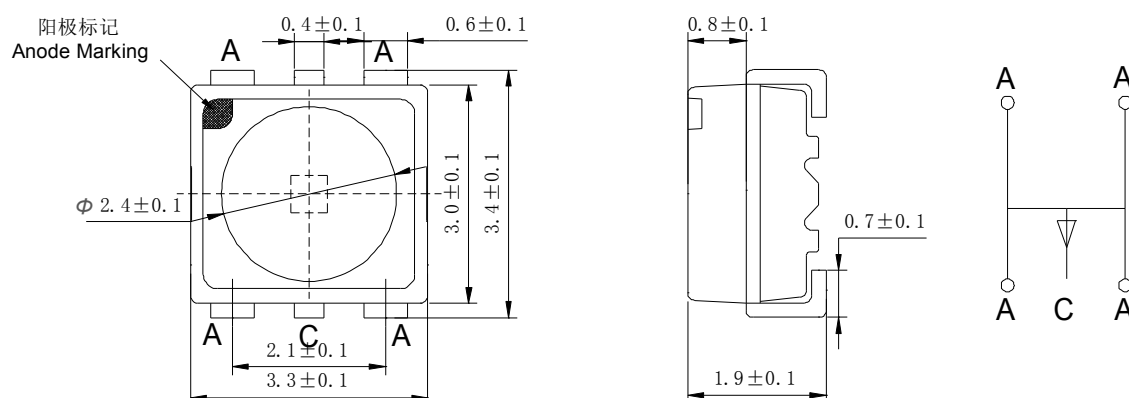

### 备注

■ 统计质量: 40mg

■ 标 记: 阳极

■ 腐蚀试验: 等级 3B

测试条件: 1) H<sub>2</sub>S 测试: 40°C / 90%R.H, 15ppm, 336小时 (标准IEC 60068-2-43)

2) 流动混合气体测试: 25°C / 75 %R.H, 500小时

(标准IEC 60068-2-60 方法 4: 10ppb H<sub>2</sub>S, 200ppb SO<sub>2</sub>, 200ppb NO<sub>2</sub>, 10ppb Cl<sub>2</sub>)

### NOTE

■ Approximate Weight: 30mg

■ Mark: Anode

■ Corrosion test: Class 3B

Test conditions: 1) H<sub>2</sub>S test: 40°C / 90%R.H, 15ppm, 336hours  
(Standards IEC 60068-2-43)

2) Flowing mixed gas test: 25°C / 75 %R.H, 500hours

(Standards IEC 60068-2-60 test method 4: 10ppb H<sub>2</sub>S, 200ppb SO<sub>2</sub>,  
200ppb NO<sub>2</sub>, 10ppb Cl<sub>2</sub>)

## 推荐焊盘 / Recommended Solder Pad

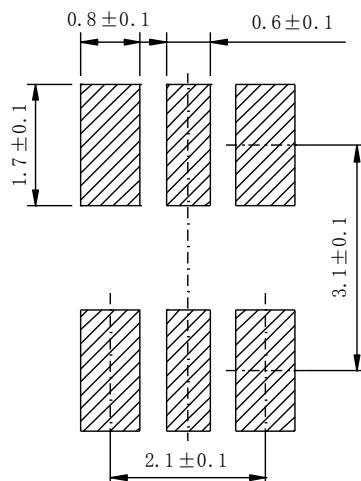

### 注释

■ 不适合超声波清洗的封装

### NOTE

■ Package not suitable for ultrasonic cleaning

## 回流焊要求 / Reflow Soldering Profile

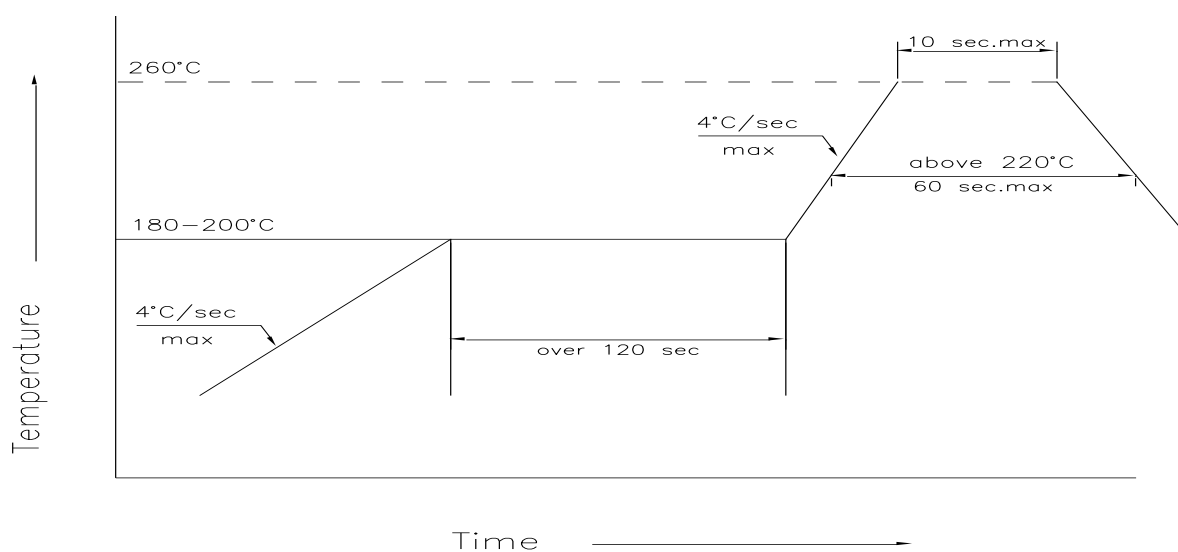

主要特性 Profile Feature	符号 Symbol	无铅焊接 Pb-Free (SnAgCu) Assembly			单位 Unit
		min.	rec.	max.	
预热升温速率 Ramp-up Rate to Preheat 25°C-150°C	-	-	2	3	°C/s
时间 / Time ( $T_{smin}$ to $T_{smax}$ )	$T_s$	60	100	120	s
峰值升温速率 Ramp-up Rate to Peak ( $T_{smax}$ to $T_p$ )	-	-	2	3	°C/s
熔点温度 Liquidus Temperature	$T_l$		217		°C
高于熔点温度的时间 Time above Liquidus Temperature	$t_l$	-	80	100	s
峰值温度 / Peak Temperature	$T_p$	-	255	260	°C
规定的峰值温度 ± 5°C 以内的时间 Time within 5°C of the Specified Peak Temperature	$t_p$	10	20	30	s
降温速率 / Ramp-down Rate ( $T_p$ to 100°C)	-	-	3	6	°C/s
时间 / Time (25°C to $T_p$ )	-	-	-	480	s

## 卷带与卷盘 / Tape and Reel

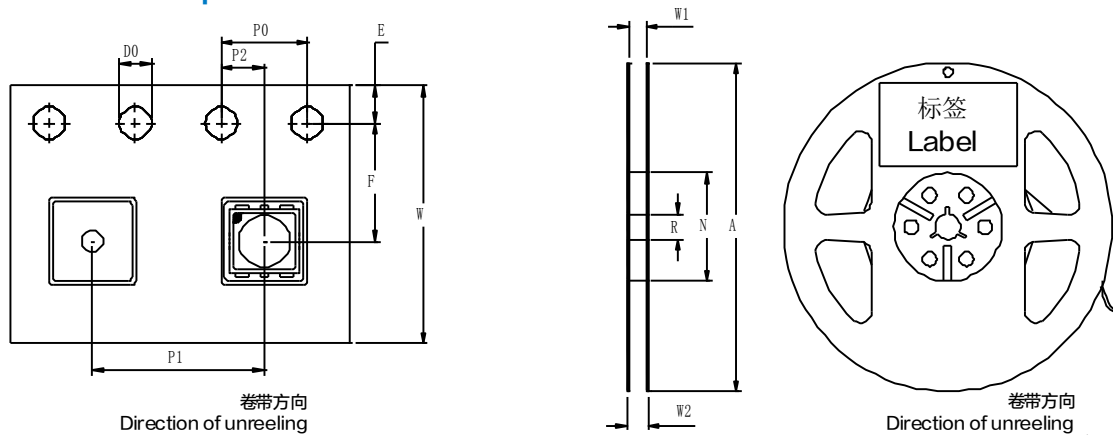

前端空带: 最小400 mm; 尾端空带: 最小160 mm; 尺寸符合: IEC 60286-3, EIA 481-D标准

Leader: min. 400 mm; Trailer: min. 160 mm; Requirement acc. to IEC 60286-3, EIA 481-D

## 卷带尺寸 / Tape Dimensions ( mm )

W	P0	P1	P2	D0	E	F
12±0.3	4±0.1	4±0.1	2±0.1	1.5+0.1/-0	1.75±0.1	5.5±0.1

## 卷盘尺寸 / Reel Dimensions ( mm )

A	W1	W2	N	R
177.8±0.1	12.7+2/-0.5	14.8+2/-0.5	58.5±0.2	13.5±0.2

## 数量 (颗/卷) / Quantity ( pcs/reel )

1000

## 条形码标签 / Barcode-Product-Label (BPL)

 **HONGLITRONIC**  
鸿利光电

 **RoHS**

**Device No:HVXX-XXXXXXX**  



**Lot No:XXXX-XXXXXXXX**  

**Product No:XXXXXXXXXXXX**  

**Qty:XXXXPCS D/C:XXXX**  

**BIN:XX-XX-XX**  
IV:XXXX-XXXX mcd  
X/Y:XX  
VF:XXX-XXX V

 **MSL:2**



## 包装材料及过程 / Dry Packing Process and Materials

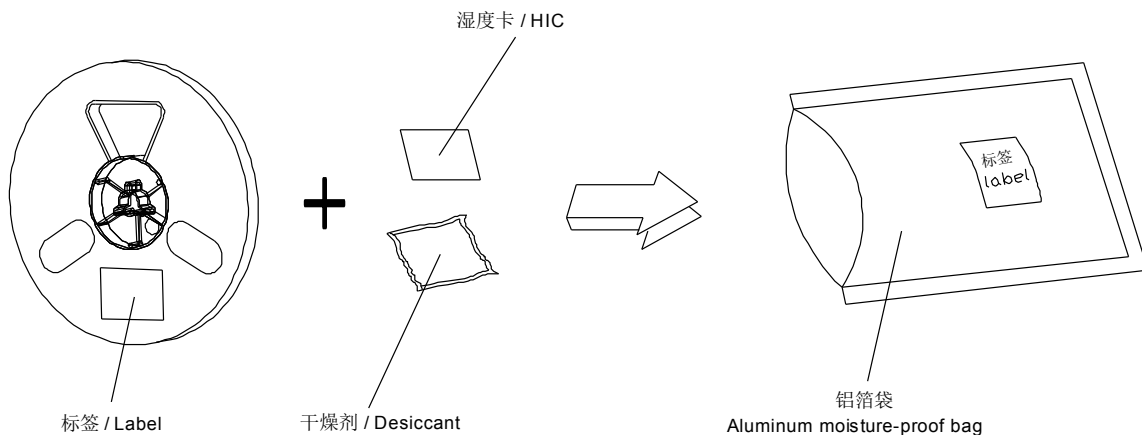

### 备注

产品包装在一个干燥的铝箔袋里，同时内附有干燥剂和湿度卡。  
对于干燥包装，您可以从网络或JEDEC标准里获取。

### NOTE

Moisture-sensitive product is packed in a dry bag containing desiccant and HIC (humidity indicator card).  
Regarding dry pack you may find further information in the internet or JEDEC.

## 出货包装及材料 / Transportation Packing and Materials

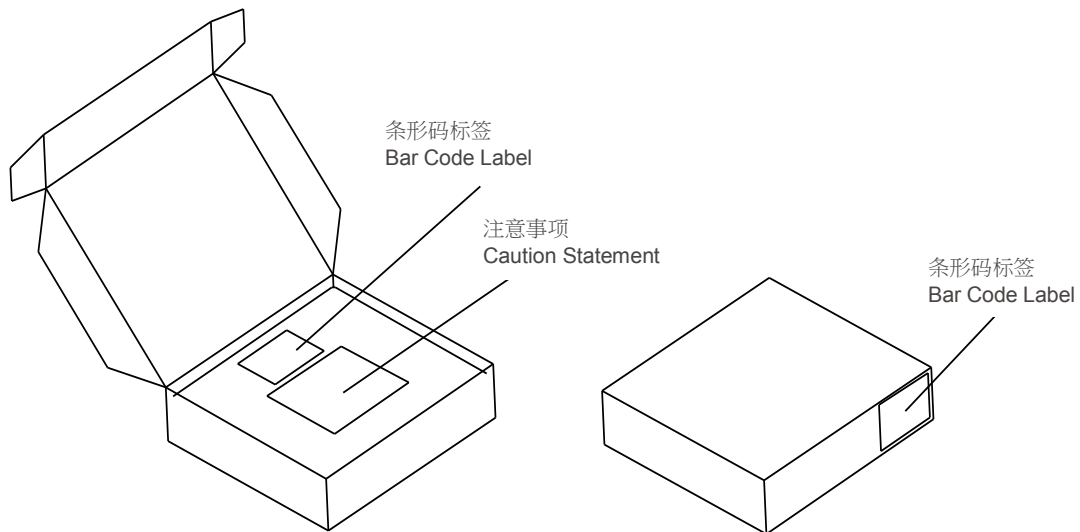

## 出货箱尺寸 / Dimensions of Transportation Box (mm)

宽度 / Width	长度 / Length	高度 / Height
256 ± 5	223 ± 5	62 ± 5
256 ± 5	223 ± 5	124 ± 5



## 注释

**典型值:** 每个产品的实际值可能与这些统计出的典型值不同。

**公差:** 除非图纸中有说明, 公差默认为  $\pm 0.1$  mm。

**正向电压:** 正向电压是在8ms脉冲电流并且内部在线性为  $\pm 0.05$ V和一个  $\pm 0.1$ V的外在不确定性 (按照GUM K=3因子) 来进行测试的。

**色度坐标:** 色度坐标是在25ms脉冲电流并且内部在线性为  $\pm 0.005$ 和一个  $\pm 0.01$ 的外在不确定性 (按照GUM K=3因子) 来进行测试的。

**亮度:** 亮度是在25ms脉冲电流并且内部在线性为  $\pm 8\%$ 和一个  $\pm 11\%$ 的外在不确定性 (按照GUM K=3因子) 来进行测试的。

**特殊声明:** 本版本最终解释权归属鸿利智汇, 当中英文意思发生歧义时, 以中文为准。

## Glossary

**Typical Values:** Actual values of each product may differ from these statistical values .

**Tolerance of Measure:** Unless otherwise noted in drawing, tolerances are specified with  $+/-0.1$ mm.

**Forward Voltage:** The forward voltage is measured during a current pulse of typically 8 ms, with an internal reproducibility of  $\pm 0.05$  V and an expanded uncertainty of  $\pm 0.1$  V (acc. to GUM with a coverage factor of  $k = 3$ ).

**Chromaticity coordinate groups:** Chromaticity coordinate groups is measured at a current pulse of typically 25 ms, with an internal reproducibility of  $\pm 0.005$  and an expanded uncertainty of  $\pm 0.01$  (acc. to GUM with a coverage factor of  $k = 3$ ).

**Brightness:** Brightness values are measured during a current pulse of typically 25 ms, with an internal reproducibility of  $\pm 8\%$  and an expanded uncertainty of  $\pm 11\%$  (acc. to GUM with a coverage factor of  $k = 3$ ).

**Special Statement:** The final interpretation of this specification shall be vested in Honglitronic, in the case of ambiguity, the Chinese version shall prevail.

## X-ON Electronics

Largest Supplier of Electrical and Electronic Components

*Click to view similar products for [Standard LEDs - SMD category](#):*

*Click to view products by [HONGLITRONIC manufacturer](#):*

Other Similar products are found below :

[LTST-C190KYKT](#) [LTST-C19GD2WT](#) [LTST-N683GBEW](#) [LTW-170ZDC](#) [LTW-M140SZS40](#) [LTW-M140ZVS](#) [598-8110-100F](#) [91-21SUBCS400-A6TR7](#) [AAAF5060QBFSEEZGS](#) [APT1608QGW](#) [99-213/R6C-AR2T1B/2C](#) [SML-LX0606SISUGC/A](#) [SML-LXR851SIUPGUBC](#) [LT1ED53A](#) [AM27ZGC03](#) [APFA3010SURKCGKQBDC](#) [APHK1608VGCA](#) [APT2012QGW](#) [LTST-008BGEW](#) [LTW-010DCG](#) [LTW-020ZDCG](#) [LTW-21TS5](#) [LTW-220DS5](#) [LO T67F-V1AB-24-1](#) [598-8330-117F](#) [CMDA20AYAA7D1S](#) [95-21SURCS530-A3TR10](#) [HSMQ-C177](#) [598-8040-100F](#) [598-8070-100F](#) [598-8140-100F](#) [598-8610-200F](#) [SML-LXL1209SYC/ATR](#) [CMD91-21VRC/TR7](#) [SML-512PWT86A](#) [SMF-2432GYC-TR](#) [EASV3015RGYA0](#) [LTST-C190KFKT-5A](#) [LTST-C194TBKT-5A](#) [CLX6E-FKC-CH1M1D1BB7C3D3](#) [SML-LXL0805USBC-TR](#) [SML-LX2835SYSUGCTR](#) [LTW-M670ZVS-M5](#) [APA2106ZGC/G](#) [CLMXB-FKA-CbcfghjnpACBB79463](#) [VFA1101W-5AY3B2-TR](#) [LCB P473-P2R2-3J7L-1-Z](#) [HSMR-C197](#) [LW A67C-S2U1-FK0KM0](#) [LW A673-P1S1-FK0PM0](#)