

# HVR-2314KPXA



## 2314 MINITOP 系列产品 / Products Series

具有高发光效率高一致性、高稳定性、高可靠性，主要用于汽车应用

High luminous efficiency, consistency, stability and reliability, it is mainly used in automobile applications.

## 特征

- 外观：白色PPA塑料，硅树脂封装
- 50%  $I_v$  视角：120°
- 颜色：红色（619~630nm）
- 资格：可靠性测试符合AEC Q102
- 潮湿敏感等级-2

## Features

- Package: silicon resin in white PPA cup
- Viewing angle at 50%  $I_v$ : 120°
- Color: Red (619~630nm)
- Qualifications: Reliability test compliance with AEC Q102
- MSL-2

## 应用

- 信号灯
- 汽车内外部照明应用

## Applications

- Signaling
- Interior and exterior lighting for automotive

## 订购信息 / Ordering Information

型号 Type	发光强度 Luminous Intensity I <sub>v</sub> @ I <sub>f</sub> = 20mA	订购编号 Ordering Code
HVR-2314KPXA - XXXX - XX - XXXX I I I 亮度档 颜色档 电压档 Brightness Color Forward Voltage	224 - 900 mcd	XXXXXX

## 备注

## ■ 亮度档

单个最小包装只装有同一个亮度档次的产品，具体分档信息请见第4页

例如：HVR-2314KPXA-S2V1-1-XXXX，单个卷盘中的产品只有S2、T1、T2、U1、U2、V1中的某一档

## ■ 颜色档

单个最小包装只装有同一个颜色档次的产品，具体分档信息请见第4页

例如：HVR-2314KPXA-XXXX-1-XXXX，单个卷盘中的产品只有1中的一档

## ■ 正向电压档

单个最小包装只装有同一个正向电压档次的产品，具体分档信息请见第4页

例如：HVR-2314KPXA-XXXX-1-3A4B，单个卷盘中的产品只有3A、3B、4A、4B中的某一档

## Note

## ■ Brightness Grouping

Only one brightness group will be packed in one reel. Please refer to page #4 for details.

E. g. : HVR-2314KPXA-S2V1-1-XXXX, means only one bin of S2、T1、T2、U1、U2or V1 is in one reel.

## ■ Color Groups

Only one color group will be packed in one reel. Please refer to page #4 for details.

E. g. : HVR-2314KPXA-XXXX-1-XXXX, means only one bin of 1 is in one reel.

## ■ Forward Voltage Groups

Only one forward voltage group will be packed in one reel. Please refer to page #4 for details.

E. g. : HVR-2314KPXA-XXXX-1-3A4B, means only one bin of 3A, 3B, 4A or 4B is in one reel.

## 极限参数 / Maximum Ratings

参数 Parameters	符号 Symbol	数值 Rating	单位 Unit
结温 / Junction Temperature	$T_j$	115	°C
正向电流 / Forward Current ( $T_s=25^\circ\text{C}$ )	$I_f$	30	mA
峰值正向电流 Peak Forward Current ( $t \leq 10\mu\text{s}$ ; $D=0.005$ ; $T_s=25^\circ\text{C}$ )	$I_{fp}$	100	mA
反向电压 / Reverse Voltage ( $T_s=25^\circ\text{C}$ )	$V_r$	不适用于反向操作 Not designed for reverse operation	V
抗静电能力 Electrostatic Discharge (HBM)	$V_{ESD}$	2000	V
操作温度 / Operating Temperature	$T_{opr}$	-40 ~ + 100	°C
储存温度 / Storage Temperature	$T_{stg}$	-40 ~ + 100	°C

特性 / Characteristics ( $T_s = 25^\circ\text{C}$ ;  $I_f = 20\text{ mA}$ )

参数 Parameters		符号 Symbol	数值 Rating	单位 Unit
峰值波长 / Wavelength at Peak Emission	typ.	$\lambda_{peak}$	628	nm
	min.	$\lambda_{dom}$	619	nm
主波长 / Dominant Wavelength	typ.	$\lambda_{dom}$	624	nm
	max.	$\lambda_{dom}$	630	nm
半波宽 / Spectral Bandwidth at 50% $I_{rel}$ max	typ.	$\Delta\lambda$	16	nm
50 % $I_v$ 下的视角 / Viewing Angle at 50 % $I_v$	typ.	$2\Phi$	120	°
	min.	$V_f$	1.90	V
正向电压 / Forward Voltage	typ.	$V_f$	2.20	V
	max	$V_f$	2.50	V
	typ.	$I_r$	0.2	uA
反向电压 / Reverse Voltage ( $V_r$ ) =5V	Max.	$I_r$	10	uA
	max.	$R_{th JS_{real}}$	330	°C/W
实际热阻值 (PN结-焊点) / Real Thermal Resistance (Junction / Solder Point)				

亮度分档 / Brightness Grouping ( $T_s = 25\text{ }^\circ\text{C}$ ;  $I_f = 20\text{ mA}$ )

档次 Grouping	发光强度	发光强度
	Luminous Intensity $I_v$ (min.)	Luminous Intensity $I_v$ (max.)
T1	280 mcd	355mcd
T2	355 mcd	450 mcd
U1	450 mcd	560 mcd
U2	560 mcd	710 mcd
V1	710 mcd	900 mcd
V2	900 mcd	1120 mcd

正向电压分档 / Forward Voltage Grouping ( $T_s = 25\text{ }^\circ\text{C}$ ;  $I_f = 20\text{ mA}$ )

档次 Grouping	正向电压	正向电压
	Forward Voltage $V_f$ (min.)	Forward Voltage $V_f$ (max.)
3A	1.90 V	2.05 V
3B	2.05 V	2.20 V
4A	2.20 V	2.35 V
4B	2.35 V	2.50 V

主波长分档 / Dominant Wavelength Grouping ( $T_s = 25\text{ }^\circ\text{C}$ ;  $I_f = 20\text{ mA}$ )

档次 Grouping	主波长	主波长
	Dominant Wavelength $\lambda_{dom}$ (min.)	Dominant Wavelength $\lambda_{dom}$ (max.)
1	619	630

## 标签信息 / Information on Label

例 / E. g. : V2-1-3B

亮度档 / Brightness	颜色 / Color	正向电压 / Forward Voltage
V2	1	3B

相对发射光谱 -  $V(\lambda)$  = 标准人眼视觉曲线

Relative Spectral Emission -  $V(\lambda)$  = Standard Eye Response Curve

$I_{rel} = f(\lambda)$ ;  $T_s = 25\text{ }^\circ\text{C}$ ;  $I_f = 20\text{ mA}$

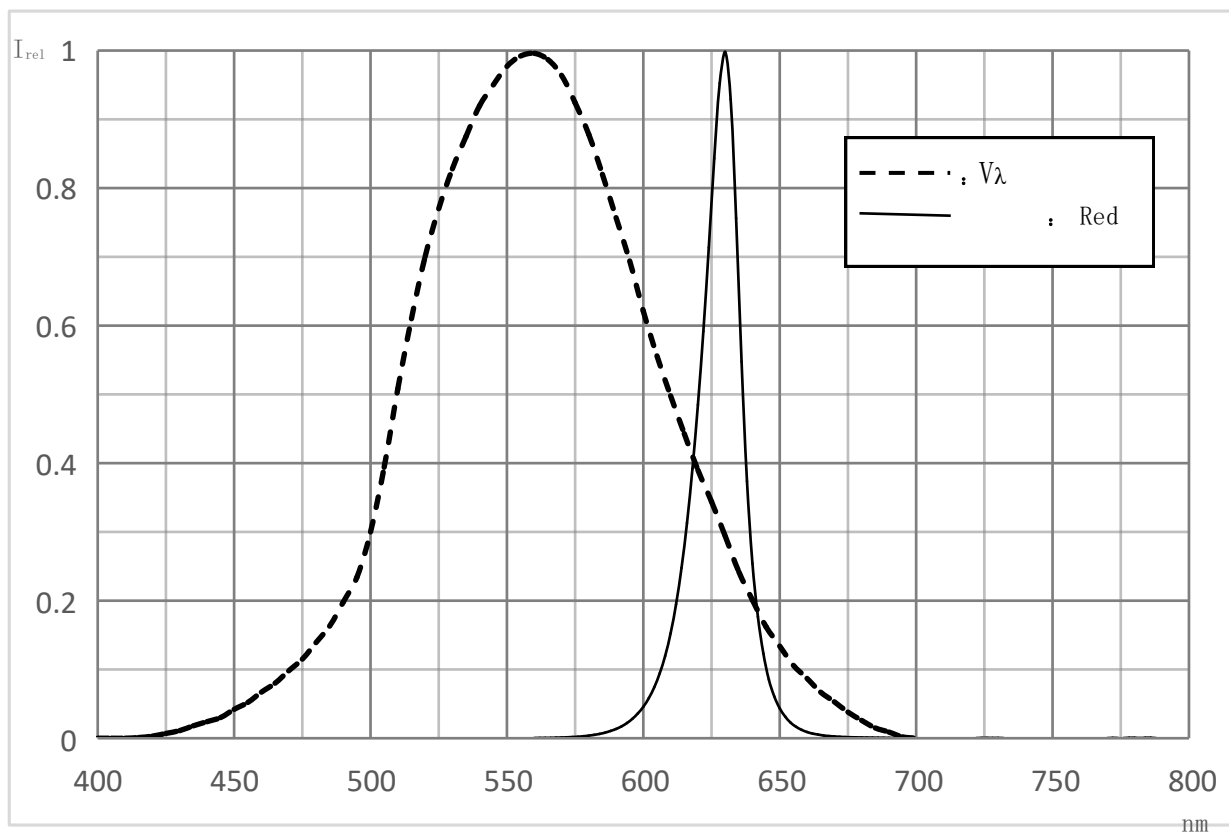

辐射特性 / Radiation Characteristics

$I_{rel} = f(\phi); T_s = 25\text{ }^\circ\text{C}$

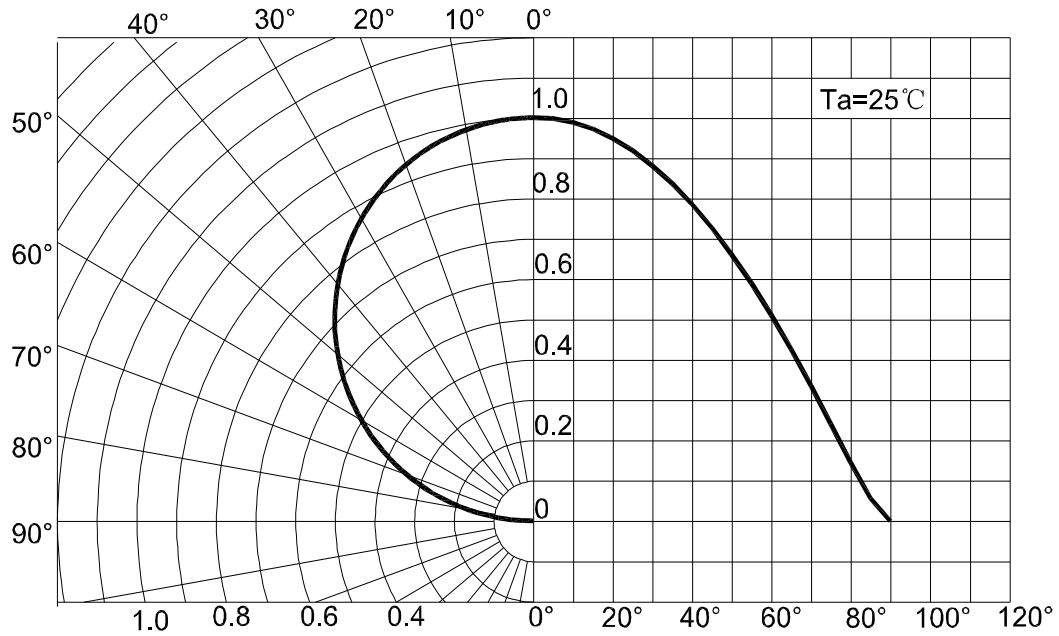

正向电流 / Forward Current

$I_f = f(V_f); T_a = 25\text{ }^\circ\text{C}$

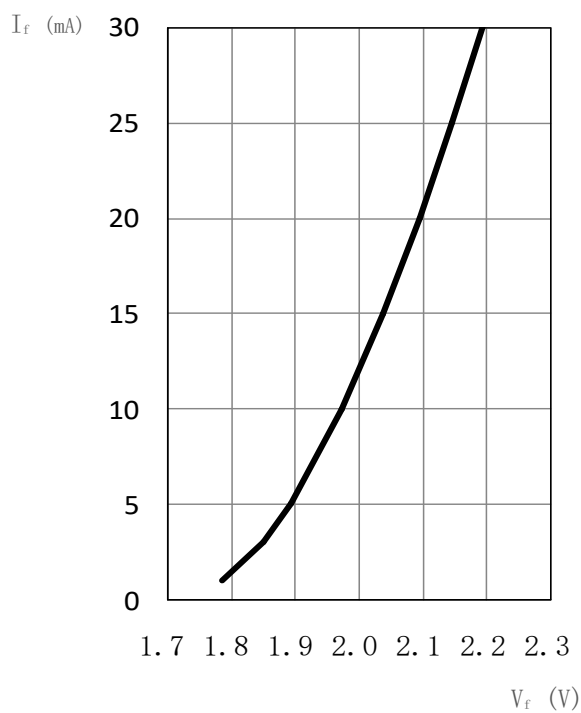

相对亮度特性曲线 / Relative Luminous Intensity

$I_v / I_v(20\text{ mA}) = f(I_f); T_a = 25\text{ }^\circ\text{C}$

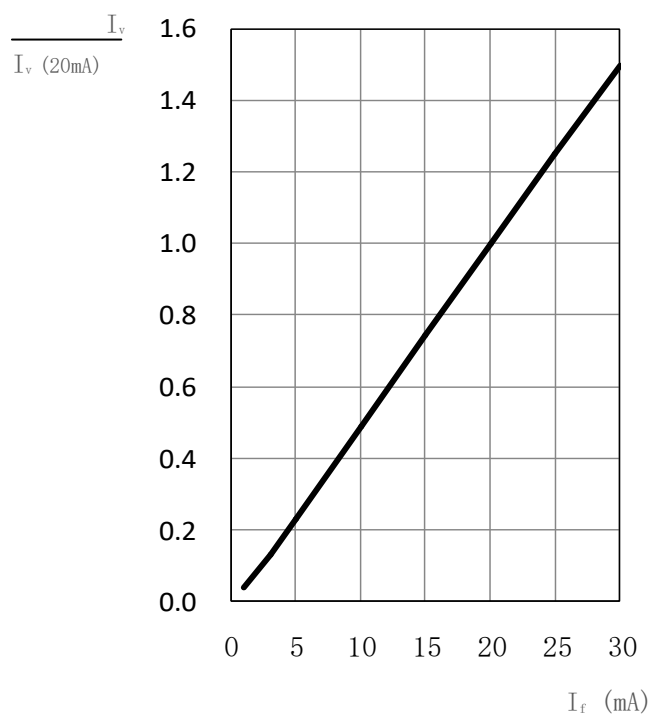

相对正向电压 / Relative Forward Voltage  
 $\Delta V_f = V_f - V_f(25^\circ\text{C}) = f(T_j); I_f = 20\text{ mA}$

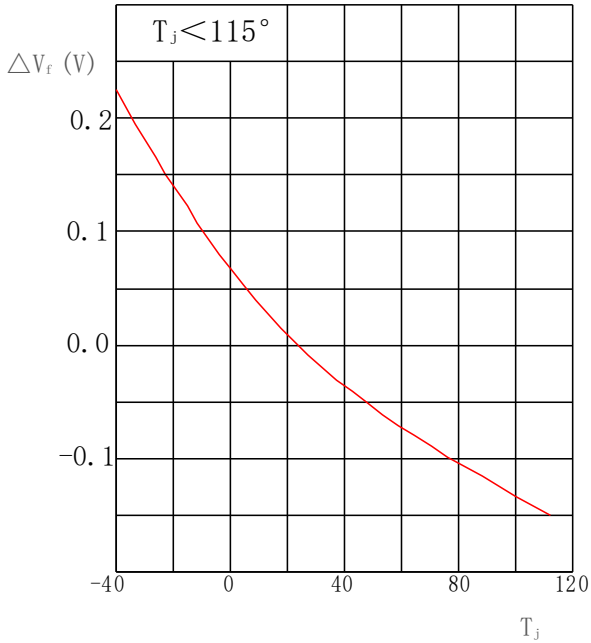

相对发光强度 / Relative Luminous Intensity  
 $I_v / I_v(25^\circ\text{C}) = f(T_j); I_f = 20\text{ mA}$

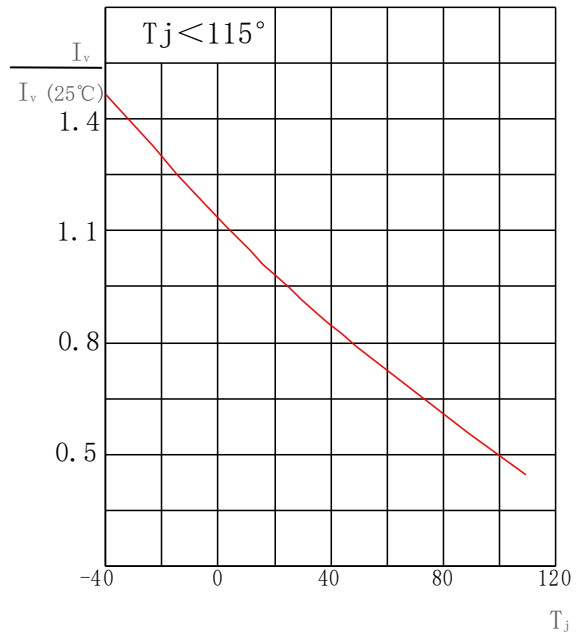

环境温度与正向电流  
 Ambient Temperature vs. Forward Current  
 $I_f = f(T_a)$

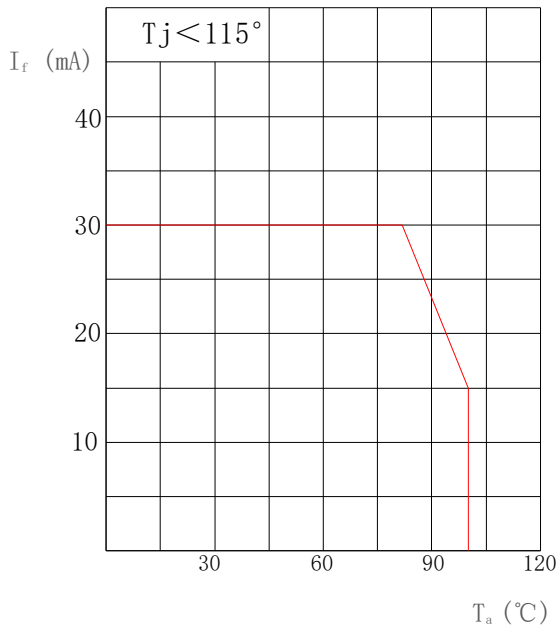

焊点温度与正向电流 / Solder Point Temperature vs. Forward Current  
 $I_f = f(T_s)$

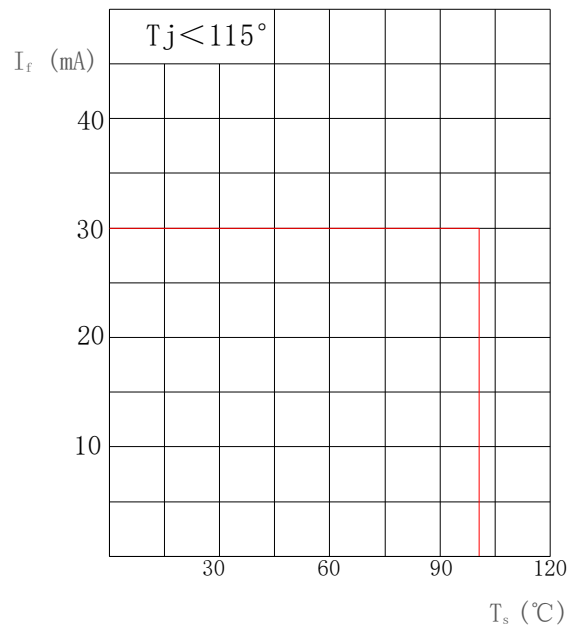

产品尺寸 / Package Outline

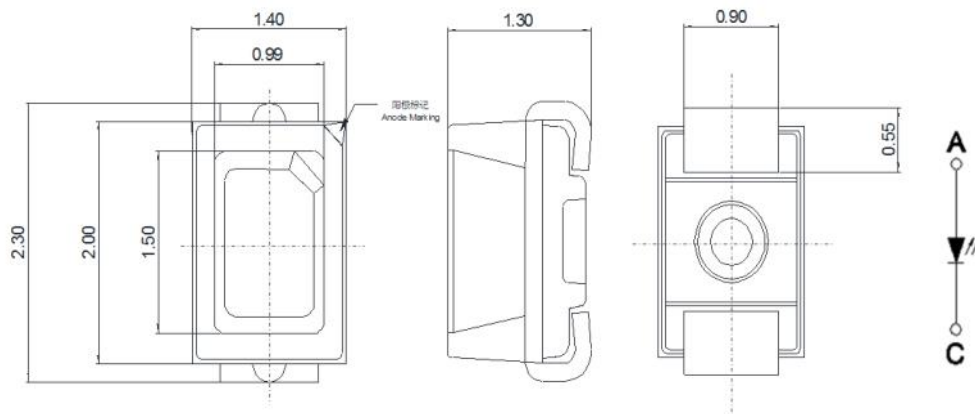

备注

- 统计质量: 10mg
- 标 记: 正极

NOTE

- Approximate Weight: 10mg
- Mark: Anode

推荐焊盘 / Recommended Solder Pad

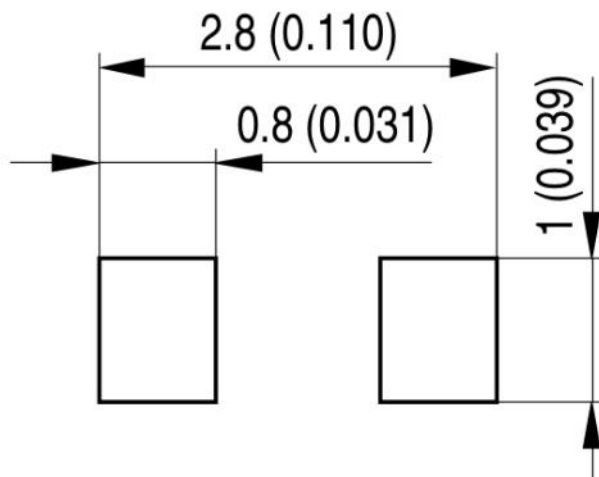

注释

- 不适合超声波清洗的封装

NOTE

- Package not suitable for ultrasonic cleaning



## 回流焊要求 / Reflow Soldering Profile

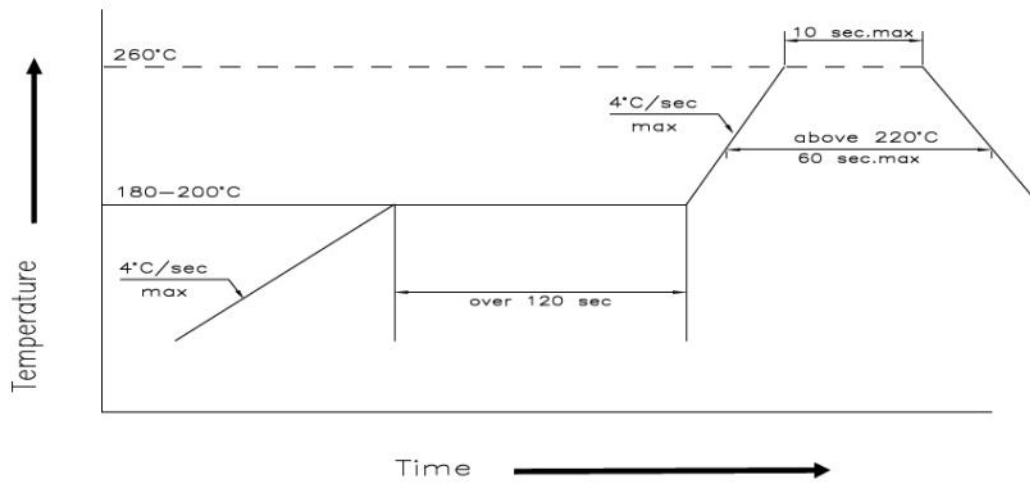

主要特性 Profile Feature	符号 Symbol	无铅焊接 Pb-Free Assembly			单位 Unit
		min.	rec.	max.	
预热升温速率 Ramp-up Rate to Preheat 25°C-150°C	-	-	2	3	°C/s
时间 / Time ( $T_{smin}$ to $T_{smax}$ )	$T_s$	60	100	120	s
峰值升温速率 Ramp-up Rate to Peak ( $T_{smax}$ to $T_p$ )	-	-	2	3	°C/s
熔点温度 Liquidus Temperature	$T_l$		217		°C
高于熔点温度的时间 Time above Liquidus Temperature	$t_l$	-	80	100	s
峰值温度 / Peak Temperature	$T_p$	-	255	260	°C
规定的峰值温度±5°C以内的时间 Time within 5°C of the Specified Peak Temperature	$t_p$	10	20	30	s
降温速率 / Ramp-down Rate ( $T_p$ to 100°C)	-	-	3	6	°C/s
时间 / Time (25°C to $T_p$ )	-	-	-	480	s

## 卷带与卷盘 / Tape and Reel

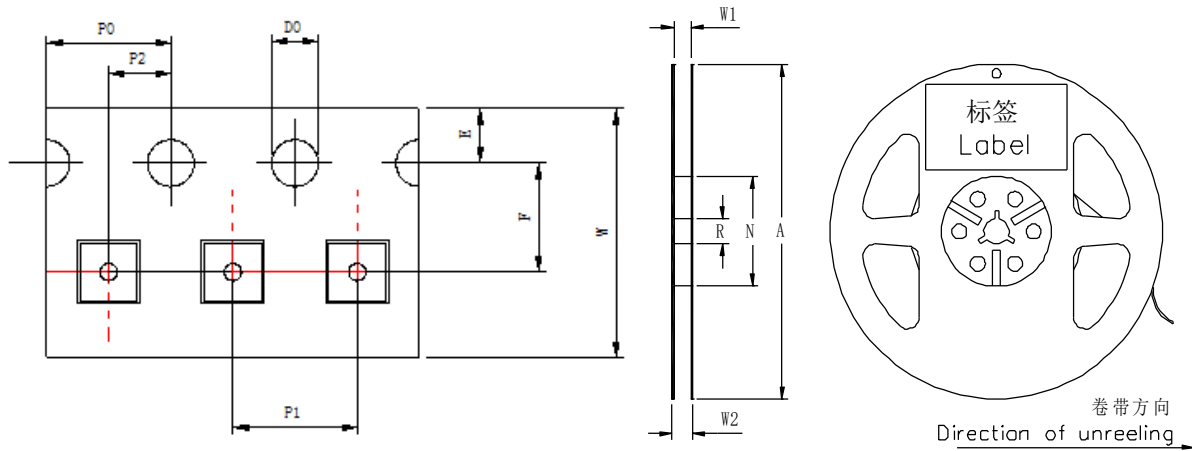

前端空带：最小400 mm；尾端空带： 最小160 mm；尺寸符合： IEC 60286-3, EIA 481-D标准  
 Leader: min. 400 mm; Trailer: min. 160 mm; Requirement acc. to IEC 60286-3, EIA 481-D

## 卷带尺寸 / Tape Dimensions (mm)

W	P0	P1	P2	D0	E	F
8±0.1	4±0.1	4±0.1	2±0.05	1.5±0.05	1.75±0.1	3.5±0.05

## 卷盘尺寸 / Reel Dimensions (mm)

A	W1	W2	N	R
177.8	9.3±0.3	11.2±0.3	58.5±0.2	13.5±0.2

## 数量 (颗/卷) / Quantity (pcs/reel)

3000

条形码标签 / Barcode-Product-Label (BPL)



包装材料及过程 / Dry Packing Process and Materials

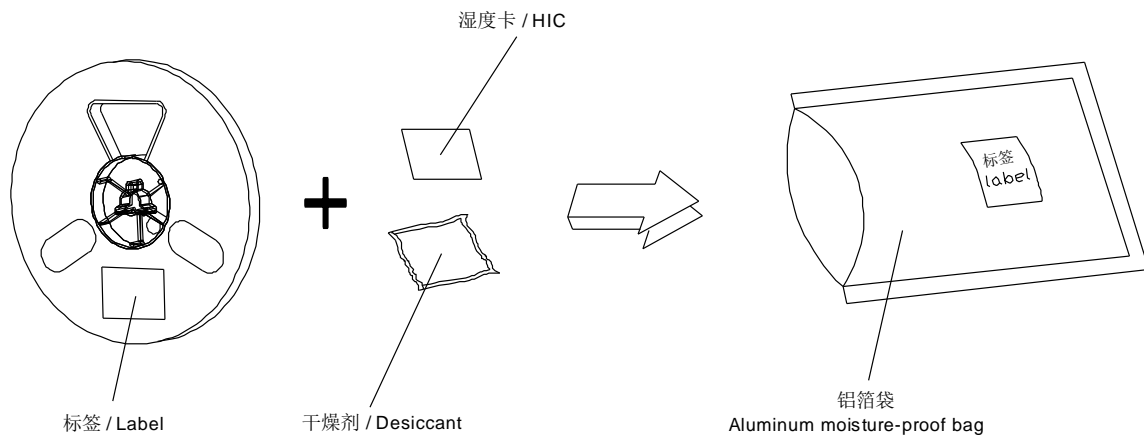

备注

产品包装在一个干燥的铝箔袋里，同时内附有干燥剂和湿度卡。  
对于干燥包装，您可以从网络或JEDEC标准里获取。

NOTE

Moisture-sensitive product is packed in a dry bag containing desiccant and HIC (humidity indicator card).  
Regarding dry pack you may find further information in the internet or JEDEC.

## 出货包装及材料 / Transportation Packing and Materials

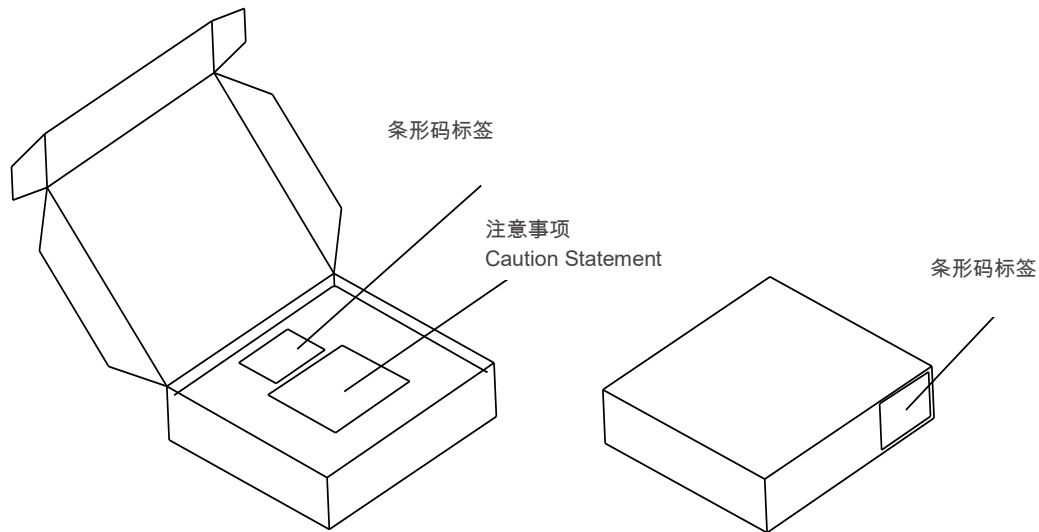

## 出货箱尺寸 / Dimensions of Transportation Box (mm)

宽度 / Width	长度 / Length	高度 / Height
256±5	223±5	62±5
256±5	223±5	124±5

## 注释

**典型值：** 每个产品的实际值可能与这些统计出的典型值不同。

**公差：** 除非图纸中有说明，公差默认为  $\pm 0.1$  mm。

**正向电压：** 正向电压是在8ms脉冲电流并且内部再现性为 $\pm 0.05$ V和一个 $\pm 0.1$ V的外在不确定性（按照GUM K=3因子）来进行测试的。

**波长：** 波长是在25ms脉冲电流并且内部再现性为 $\pm 0.5$ nm和一个 $\pm 1$ nm的外在不确定性（按照GUM K=3因子）来进行测试的。

**亮度：** 亮度是在25ms脉冲电流并且内部再现性为 $\pm 8\%$ 和一个 $\pm 11\%$ 的外在不确定性（按照GUM K=3因子）来进行测试的。

**特殊声明：** 本版本最终解释权归属鸿利智汇，当中英文意思发生歧义时，以中文为准。

## Glossary

**Typical Values:** Actual values of each product may differ from these statistical values .

**Tolerance of Measure:** Unless otherwise noted in drawing, tolerances are specified with +/-0.1mm.

**Forward Voltage:** The forward voltage is measured during a current pulse of typically 8 ms, with an internal reproducibility of  $\pm 0.05$  V and an expanded uncertainty of  $\pm 0.1$  V (acc. to GUM with a coverage factor of  $k = 3$ ).

**Wavelength:** The wavelength is measured at a current pulse of typically 25 ms, with an internal reproducibility of  $\pm 0.5$  nm and an expanded uncertainty of  $\pm 1$  nm (acc. to GUM with a coverage factor of  $k = 3$ ).

**Brightness:** Brightness values are measured during a current pulse of typically 25 ms, with an internal reproducibility of  $\pm 8\%$  and an expanded uncertainty of  $\pm 11\%$  (acc. to GUM with a coverage factor of  $k = 3$ ).

**Special Statement:** The final interpretation of this specification shall be vested in Hongli-tronic, in the case of ambiguity, the Chinese version shall prevail.

## X-ON Electronics

Largest Supplier of Electrical and Electronic Components

*Click to view similar products for [Standard LEDs - SMD category](#):*

*Click to view products by [HONGLITRONIC manufacturer](#):*

Other Similar products are found below :

[LTST-C190KYKT](#) [LTST-C19GD2WT](#) [LTW-170ZDC](#) [LTW-M140SZS40](#) [LTW-M140ZVS](#) [598-8110-100F](#) [598-8610-202F](#) [91-21SUBCS400-A6TR7](#) [AAAF5060QBFSEEZGS](#) [APT1608QGW](#) [99-213/R6C-AR2T1B/2C](#) [SML-LX0606SISUGC/A](#) [SML-LXR851SIUPGUBC](#) [LT1ED53A](#) [APFA3010SURKCGKQBDC](#) [APHK1608VGCA](#) [APT2012QGW](#) [LTST-008BGEW](#) [LTW-010DCG](#) [LTW-020ZDCG](#) [LTW-21TS5](#) [LTW-220DS5](#) [598-8330-117F](#) [65-21SYGC/S530-E3/TR8](#) [CMDA20AYAA7D1S](#) [95-21SURCS530-A3TR10](#) [598-8040-100F](#) [598-8070-100F](#) [598-8140-100F](#) [598-8610-200F](#) [SML-LXR851SGSIC-TR](#) [SML-512PWT86A](#) [EASV3015RGYA0](#) [95-21UYC-S530-A5-TR7](#) [LTST-C190KFKT-5A](#) [LTST-C194TBKT-5A](#) [CLX6E-FKC-CH1M1D1BB7C3D3](#) [SML-LXL0805USBC-TR](#) [SML-LX2835SYSUGCTR](#) [LTW-M670ZVS-M5](#) [APA2106ZGC/G](#) [CLMXB-FKA-CbcfghjnpACBB79463](#) [KPTD-2012LVVBC-D](#) [VFA1101W-5AY3B2-TR](#) [LCB P473-P2R2-3J7L-1-Z](#) [91-21VGC/S556/S68/TR10/S370](#) [LW A67C-S2U1-FK0KM0](#) [LW A673-P1S1-FK0PM0](#) [BL-HE1G033B-TRB](#) [5988B90107F](#)