



Under Development	
Mass production	●

RoHS

Specification 规格书

Client Name:

客户名称: _____

Client P/N:

客户品号: _____

Product P/N:

产 HL-LM002H384W-9B4C12(Ra2)

品型号:

Sending Date: _____

Client approval 客户审核		Hongli approval 鸿利智汇审核		
Approval 核准	Audit 确认	Audit 确认		Confirma- tion 制作
		Sales department 营销中心	Quality department 品质部	Engineering technol- ogy centre 工程技术中心
				 刘焕聪
<input type="checkbox"/> Qualified 接受 <input type="checkbox"/> Disqualified 不接受		DATE: 日期:		

Adr: No. 1, Xianke Yi Road, Huadong Town, Huadu District, Guangzhou, China

地址: 中国广州市花都区花东镇先科一路1号

Tel/电话: 020-37705135

Fax/传真: 020-37705136

注: 1. 此规格书以中英文方式书写, 若有冲突以中文版本为准文本.

2. 此规格书的最终解释权归鸿利智汇集团股份有限公司

3. 此规格书的有效期限为两年, 自盖章或签字之日起计算, 期满时双方可以续签协议, 但应采用书面形式



Under Development	
Mass production	●

Catalog目录

1. Product naming rules	
产品命名规则	3
2. Features	
特点	3
3. Application range	
应用范围	4
4. Package Dimensions封装尺寸	
封装尺寸	4
5. Performance	
性能	4-5
6. Characteristics特性	
特性	6
7. Bin Range	
Bin区分类	7
8. Product coding Information	
产品喷码信息	8
9. Packing Specifications	
包装规格	9
10. Use the matters needing attention	
使用注意事项	10-12
11. Resume	
履历表	13

1. Part code 产品型号命名原则

LM 002 H384 W - 9 B4 C12 (Ra2)

① ② ③ ④ ⑤ ⑥ ⑦ ⑧

- ① Product line code 产品系列代码
- ② Product code base plate 产品基板代码
- ③ Chip code 芯片代码
- ④ Emitting light colors 发光颜色
- ⑤ Recommend the minimum Power
建议使用的最小功率
- ⑥ The number of parallel Circuit 并联电路数
- ⑦ The number of series Circuit 串联电路数
- ⑧ CRI 显色指数 Ra2: $Ra \geq 80$

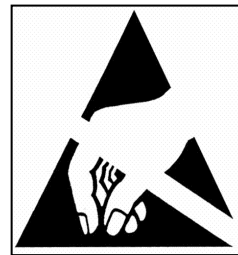
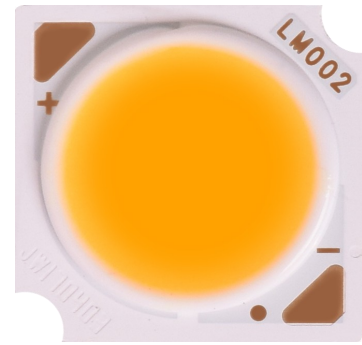

ATTENTION注意
OBSERVE PRECAUTIONS
FOR HANDLING
ELECTROSTATIC
DISCHARGE
SENSITIVE
DEVICES

请勿裸手接触器件

2.Features 特点

- Dimension 13.5mm×13.5mm×1.6mm : 尺寸13.5mm×13.5mm×1.6mm
- Chip Base on Aluminum Board: 镜面铝基板封装
- RoHS compliant (ROHS标准)
- 3-step MacAdam Ellipse (3阶出货)
- sulphation corrosion resistance 抗硫化
- Light-Emitting Diode 发光二极管

3.Applications 应用

- Down light 筒灯
- Spot light 射灯

4.Package Dimensions 封装尺寸

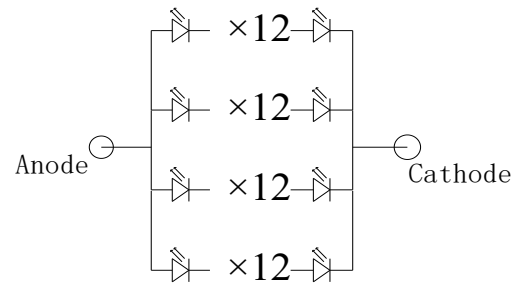
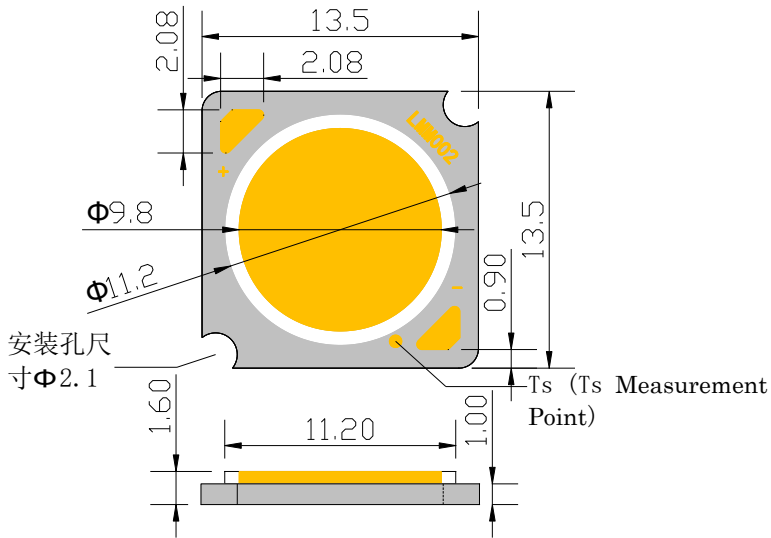

Tolerance unless otherwise specified: $\pm 0.3\text{mm}$.
 尺寸公差为 ± 0.3 毫米除非另有说明

5.Performance 性能

(1) Absolute Maximum Ratings 绝对最大额定值

Parameter参数	Symbol符号	Rating Value值	Units单位
Power Dissipation (功耗)	Pd	22	W
Forward Current (正向电流)	IF	600	mA
Junction Temperature结温	Tj	120	°C
TS Temperature (TS温度) / 沉降产品	Ts	85 ^{*1}	°C
Storage Temperature Range 储藏温度	Top	-40~85	°C
Operating Temperature Range 工作温度	Top	-40~85	°C
Lead Soldering Temperature* 引线焊接温度	T _{SOL}	Max. 350°C for 5sec Max.	

Notes for Table:

1.The temperature of Aluminum PCB do not exceed 85°C. If the input power reach 80% max Pi, the temperature of Aluminum PCB should be control below 75°C

基板负极引线温度不能超过85°C. 如果输入功率达到最大输入功率的80%以上, 基板负极引线温度应控制在75°C以内.

2.When hand soldering, keep the temperature of iron below less 350°C less than 5seconds

当手工焊接时, 烙铁的温度必须小于350°C, 时间不能超过5秒



(2) Electro-Optical Characteristics 光电特性

Parameter参数	Symbol符号	Condition 条件	Min.	Typ.	Max.	LM/W (typ)	Unit 单位
Forward Voltage 正向电压	VF	IF=350mA	34	36	40	—	V
Luminous Flux 光通量	Φv	TC=1800-2000K	1000	1050	1140	105	Lm
		TC=2200-2400K	1360	1440	1570	114	
		TC=2300-2500K	1310	1390	1520	110	
		TC=2500K	1370	1460	1580	116	
		TC=2700K	1530	1600	1730	127	
		TC=3000K	1470	1550	1680	120	
		TC=3500K	1410	1555	1710	130	
		TC=4000K	1530	1620	1760	127	
		TC=5000K	1540	1620	1740	128	
		TC=5700K	1550	1650	1800	130	
		TC=6000±300K	1500	1600	1730	127	
		TC=6500K	1500	1600	1730	127	
CRI 显色指数	Ra	IF=350mA	80	—	—	—	—
Thermal Resistance 热阻	R (j-s)	IF=350mA	—	1.95	—	—	°C/W

Notes for Table

*1. Color bins are defined at IF=350mA operation. If use different forward current, it will cause the change of chromaticity and forward voltage.

该产品通过瞬态350mA 点亮, 分光分色. 若使用不同电流, 会引起色温及电压的变化

*2. The tolerance of measurement at our tester is VF±3%, Φv±10% and Ra±2.

测试仪测量的公差在电压±3%, 流明±10% 和显指±2.

3. Tolerance of ±0.005 on x,y coordinates.

色坐标的测量误差允许在±0.005

4. Color region stay within MacAdam "3-step" ellipse from the chromaticity center. but does not contain the color temperature 6000±300K. The chromaticity center refers to ANSI C78.377-2008.

色域可控制在色温中心坐标的3阶麦克亚当椭圆之内, 但不包括色温6000±300K, 色温分bin参考ANSI C78.377-2008.

5. The symbol of"/"in the sheet represents that this parameter is uncontrolled.

表格中/代表此参数不管控。

6. With "★" for the product the main push color segment.

带"★"为产品主推色温段。



Under Development	
Mass production	●

6.Characteristics特性

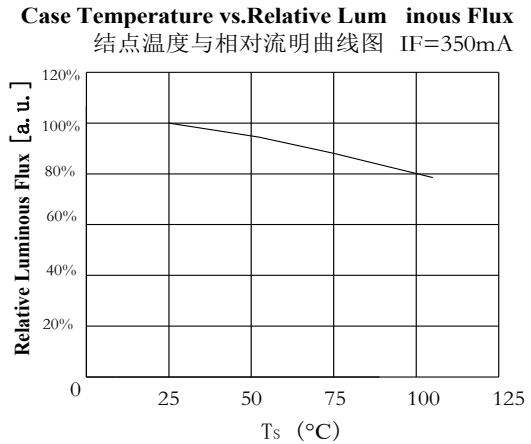
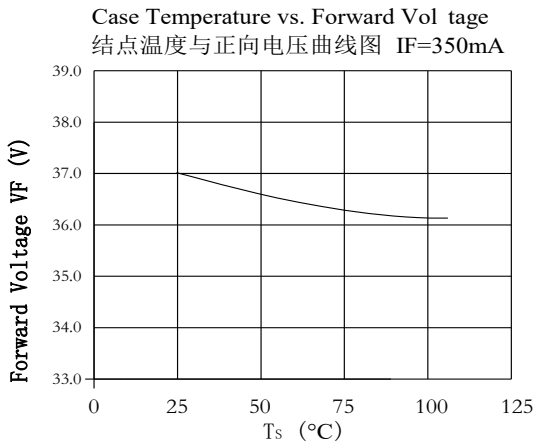
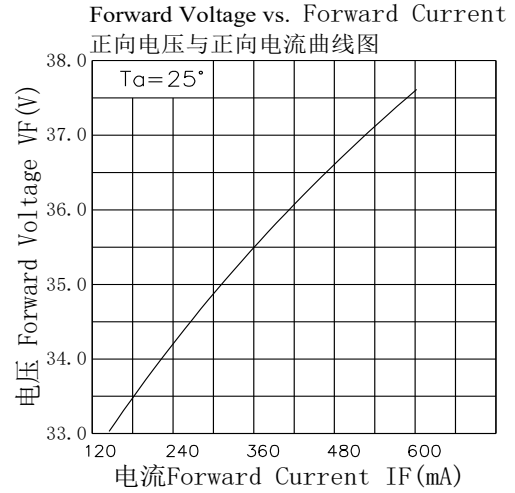
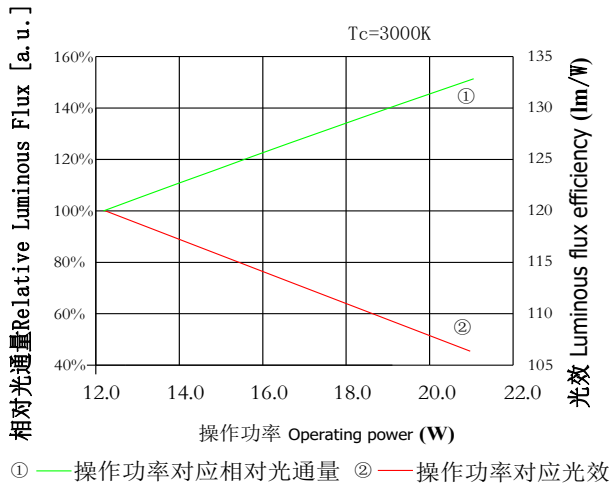

Spectrum

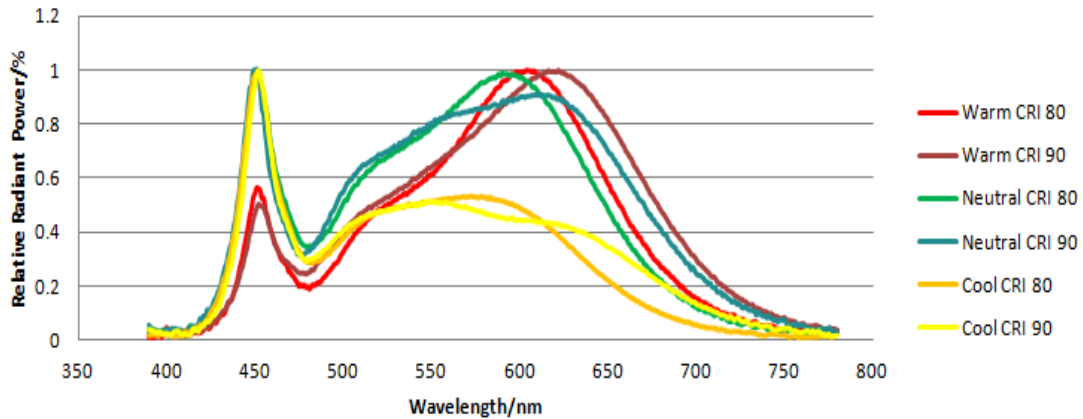



7. Bin Range of Chromaticity Coordinate Bin区分类及色坐标范围

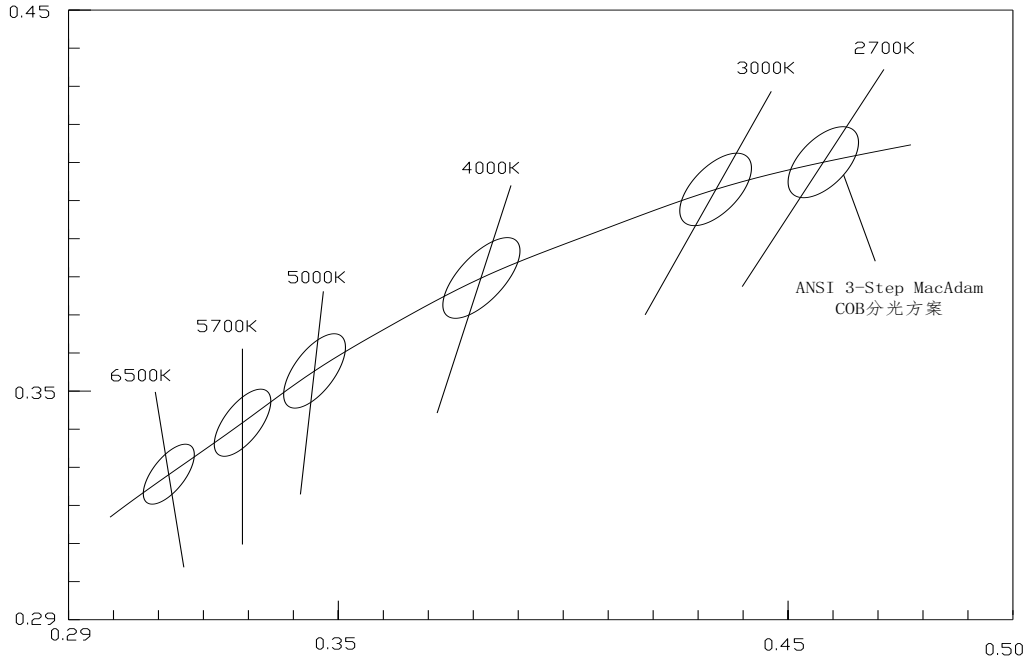

CCT 色温	CIE_x	CIE_y	A	B	Θ
6500K	0.3123	0.3282	0.00669	0.00285	58.57
6000K	0.3214	0.3353	0.00708	0.00302	59.21
5700K	0.3287	0.3417	0.007458	0.003198	59.09
5000K	0.3447	0.3553	0.00822	0.00354	59.62
4500K	0.3611	0.3658	0.00881	0.00378	54.35
4000K	0.3818	0.3797	0.00939	0.00402	53.72
3500K	0.4073	0.3917	0.00927	0.00414	54.00
3000K	0.4338	0.4030	0.00834	0.00408	53.22
2700K	0.4578	0.4101	0.0081	0.0042	53.7

Color region stay within MacAdam "3-step" ellipse from the chromaticity center. but does not contain the color temperature 6000±300K. The chromaticity center refers to ANSI C78.377-2008.

色域可控制在色温中心坐标的3阶麦克亚当椭圆之内，但不包括色温6000±300K，色温分bin参考ANSI C78.377-2008。



Under Development	
Mass production	●

8.Product coding Information 产品喷码信息

A 30 80 12 05 XC AA
 ① ② ③ ④ ⑤ ⑥ ⑦

背面喷码图

510D-2004009

⑧

A30801205XCAA

510D20040009

① 色温标准 A: ANSI标准 F: IEC标准

② 色温 27=2700K
 30=3000K
 40=4000K
 XX=XX00K

③ 显色指数 70=Ra1
 80=Ra2
 90=Ra4
 95=Ra5
 97=Ra7

型号不带显指用“XX”

④ 串数 12=12串
 XX=XX串

⑤ 并数 05=5并
 XX=XX并

⑥ 应用范围/客户名称代码 (此项可为空)

应用范围: XC=服装照明
 FL=家具照明
 SXD=生鲜照明

⑦ 芯片代码

⑧ 工单代码



Under Development	
Mass production	●

9.Packing Specifications 包装规格

 HONGLITRONIC 鸿利光电		
TYPE:		QTY:
VF:	IF:	ΦV:
TC:	X/Y:	
SDCM<	Ra>	
DATE:		LOT.NO:

Label on ESD shielding 静电袋上标签

 HONGLITRONIC (Product Identity Card) 鸿利光电		成品标示卡 
品名 (Description):		
产品型号 (Type):		
发光颜色 (Color):		
数量 (QTY):		
生产批号 (LOT NO):		
出货日期 (Date):		
操作员 (Operator):		

Label on box 外箱标签

ΦV: Luminous Flux rank 光通量档次范围

VF: Forward voltage rank 正向电压档次范围

TC: Color temperature 色温

SDCM: 相对色容差

■ Packing figure 包装图

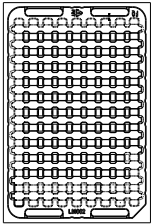

Tray: 108pcs
L*W*H=308*208*8mm

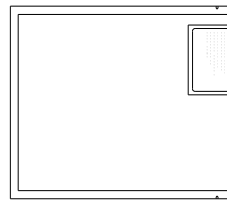
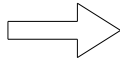

6Tray/Aluminium Foil Bag:648pcs
L*W*H=400*300*0.12mm

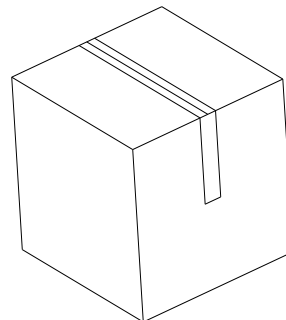

10 Aluminium Foil Bag/Outer Box:6480pcs
L*W*H=395*245*350mm

10. Precaution for use (防护措施)

1. Storage 储存

To avoid moisture, we recommend storage conditions for the unopened LED +5 ~ +30 °C, relative humidity <60%. LED should be used within 168 Hrs. of opening the package. Please make sure to dehumidify and vacuum pack the remaining/ unused LED. Dehumidifying condition: +120 °C ± 5 °C, 04 Hrs. Effective age for the sealed led is one year.

为避免受潮的影响，我司建议产品在未开包装前储存条件为 5-30° C，相对湿度小于 60%。已开包装的 LED 光源请在 168H 内使用安装完毕，如未用完之产品，请进行除湿并抽真空后密封保存。除湿条件：120° C ± 5° C，4H。产品密封保存有效使用期为一年。

2. The soldering precautions 组装注意事项：

Soldering conditions: Reflow soldering is not recommended for this LED. If hand soldering, set soldering iron temperature at 350°C and soldering time not More than 5 seconds, Contacts number of soldering bit should be within twice for each terminal, after the first soldering, make sure the substrate surface temperature returns to ambient temperature before a second soldering. Please make sure when soldering, there is no external force on the soldering surface and silicon batardeau (such as pressure, friction or sharp metal nails, etc.), to avoid gold wire deformation or damage and other abnormalities. If beyond recommended conditions, we cannot guarantee the LED stability, please do the risk assessment first.

During assembly, please ensure that a good quality thermal paste is applied and distributed evenly over the surface. While using thermal pad (Heat Sink), make sure LED is firmly tightened and there is no gap between surfaces. In such heat-media products, through a pressure test of at least 500 volts.

焊接条件：此产品不推荐使用回流焊接的作业方式，手工焊接烙铁温度设定 350°C，焊接时间不可超过 5 秒，当手工焊接时，烙铁的温度必须小于 350°C，时间不能超过 5 秒，焊接次数控制在两次以内，第一焊点焊接后请确保基板表面温度恢复到环境温度，方可进行第二次的焊接。焊接时请注意不可有外力作用于胶体表面及外圈的围堰胶上（如压力，摩擦或锋利金属钉等），以免造成金线变形或断线等异常；如果超出此使用条件，鸿利智汇将不能保证产品的稳定性，如需使用超出的操作条件，请务必进行风险评。

为确保在组装时降低接触热阻，请注意导热膏涂布均匀且分布面积合理，不可出现导热膏太少或涂抹高低不平等现象。如使用导热胶垫时，请确保螺丝安装后基板与导热胶垫的完全接触，不可存在中空现象。产品在此类耐热介质下，能通过至少 500 伏的耐压测试。



OK



NG

3. Anti-Static Measures防静电措施:

Please take adequate measures to prevent electrostatic generation, such as wearing electrostatic ring or anti-static fingerstall etc; any relative products like plant equipment, machinery, carrier and transportation units shall be connected to discharging unit/ ground. The ESD sensitivity of this product is > 1000V(HBM), after assembly the final lamp, please make sure to discharge Static Electricity by proper ESD equipment.

请采取足够的措施来防止静电产生，比如带静电环或防静电手指套等；每个制造厂关于产品（工厂、设备、机器、载波机和运输单位）应当连接到底面，请避免产品电气带电；本产品的防静电敏感度超过1000V(HBM)，装配后的最终灯具产品（S）建议检查是否损坏LED（漏电现象）。

4. Temperature Control温度控制:

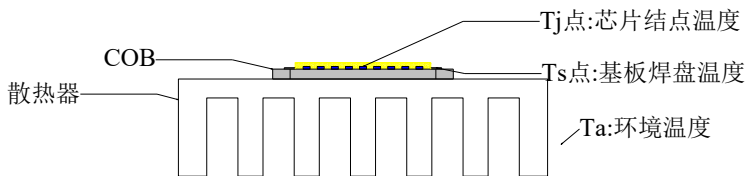

$$T_j = T_s + R_{j-s} * P_i$$

其中 T_j =芯片结点温度， T_s =基板测试焊盘温度， P_i =输入功率

T_j : Chip junction temperature, T_s : pad temperature, P_i : power

Recommended temperature conditions for enhanced product life: the T_s point (negative pads) should not exceed the absolute maximum rating in LED illumination system, COB recommendation colloid surface temperature control $\leq 180^\circ\text{C}$.

保证散热前提条件为：请务必将 T_s 点（负极焊盘）控制在对应系统最高范围内，建议COB胶体表面温度控制 $\leq 180^\circ\text{C}$ 。

5. The drive control驱动控制: :

Drive this product at constant current. Output current range specifications should be according to the operational and other conditions, as mentioned in data sheet. Before using a constant voltage source or altered specifications other than recommended, please consider risk factors.

本产品需使用恒流源进行驱动，且输出电流符合规格书上的功率使用范围，如需使用恒压源或其他使用条件，请进行使用效果风险评估。

The Peak Current: The LED chip will be burned easily if the LED is shocked by the current which is higher than the rated current in a short time. Please make sure that the current of the LED is less than the maximum current when the power is on .

电流尖峰：LED受到一个短暂大于额定电流的冲击，容易造成芯片烧毁现象。请务必保证电源开启瞬间电流小于光源使用最大电流。

6. a minimum current value 最小电流值点亮

A minimum current value of lighting of Per die is less than 1mA. When a minimum current is applied, LED dice may look different in their brightness due to the individual difference of the LED element, But does not affect the use, if one of the chip is particularly bright, then we need to evaluate its using effect.

COB产品每颗芯片单颗电流小于等于1mA进行点亮检测，LED芯片的亮度可能会有所不同，但不影响使用，如出现某颗芯片特别亮，需评估其使用效果。

7. Other其他:

Product is not suitable to use in following conditions

本产品不可在以下条件下使用，如果产品在以下条件下使用，评估其使用效果和风险是有必要的：

Direct or indirect wet / damp conditions, such as rain, etc.;

直接或间接的打湿或受潮，比如淋雨等；

In contact with sea water and erosive materials

被海水损害或侵蚀；

Exposed to corrosive gases (e.g., Cl₂, H₂S, NH₃, SO_x, NO_x, etc.);

被暴露于腐蚀性气体(如 Cl₂, H₂S、NH₃、SO_x、NO_x等)；

Exposed to dust, liquids or oils;

被暴露于粉尘、液体或油；

镜面铝基板防硫化标准：

Standard for vulcanization resistance of mirror aluminum substrates. From the date of COB shipment, the sulfur concentration of the Luminaire should be less than 2000PPM, and the surface temperature should be within the required range of our company. Luminaire sulfur element can be sulfur compound, except the elemental sulfur, as the volatilization of elemental sulfur will cause the protective layer of the substrate damaged and blackened at high temperature

COB从出货日起，灯具硫浓度小于2000PPM，胶面温度在我司要求范围内。灯具硫元素可为硫化物，不能出现单质硫，单质硫在高温情况下挥发将引起基板保护层破坏，发黑。

Other points for attention, please refer to our LED user manual, In accordance with the user manual, the product shelf life is 24 months, If there is a warranty agreement, the warranty agreement shall prevail. After the product life cycle for recycling.

其它注意事项请参照我们的LED使用手册，符合使用手册的情况下，产品质保期为24个月，有保质协议的则以保质协议为准。产品生命周期后进行回收处理。

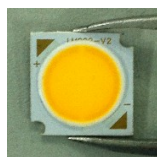

OK

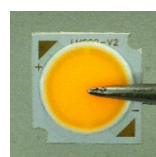

NG

修订次数	修订人	修订内容	修订日期	版次
7	苏国强	3000K光通量由1420-1500-1660改为1520-1600-1760lm	2020. 11. 25	A/6
8	苏国强	新增1800-2000K光通量1000-1050-1140	2020. 12. 14	A/6
9	刘焕聪	更新规格书格式	2021. 11. 16	A/7
10	郑舟洲	更改4000K光通量为1480-1560-1690	2021. 11. 16	A/7
11	莫家强	更改3000K光通量为1580-1650-1770lm	2022. 1. 11	A/7
12	莫家强	5700K光通量改为1680-1760-1890lm	2022. 2. 21	A/7
13	郑舟洲	更改2700K光通量1530-1600-1730lm	2022. 04. 12	A/7
14	莫家强	3000K光通量由1580-1650-1770改为1470-1550-1680lm	2022. 7. 1	A/7
15	莫家强	5700K光通量由1680-1760-1890改为1550-1650-1800lm	2022. 8. 26	A/7
16	郑舟洲	更改4000K光通量为1650-1730-1860lm	2022. 10. 29	A/7
17	莫家强	4000K光通量由1650-1730-1860改为1520-1600-1730lm	2022. 12. 8	A/7
18	莫家强	3500K光通量由1410-1500-1620改为1600-1700-1830	2023. 2. 19	A/7
19	周文秀	4000K光通量改为1640-1730-1880lm	2023. 5. 28	A/7
20	郑舟洲	4000K光通量改为1530-1620-1760lm	2023. 6. 25	A/7
21	周文秀	3500K光通量改为1410-1555-1710lm	2023. 8. 17	A/7

X-ON Electronics

Largest Supplier of Electrical and Electronic Components

Click to view similar products for [High Power LEDs - White category:](#)

Click to view products by [HONGLITRONIC manufacturer:](#)

Other Similar products are found below :

[LTW-K140SZR40](#) [LTPL-P00DWS57](#) [LTW-K140SZR30](#) [LZP-D0WW00-0000](#) [LTW-K140SZR57](#) [LTW-K140SZR27](#) [BXRC-35E10K0-D-73](#)
[MP-5050-6100-65-80](#) [KW CSLPM2.CC-8L8M-4L8N](#) [KW CSLPM2.CC-8L8M-4O9Q](#) [KW DPLS32.SB-6H6J-E5P7-EG-Z264](#) [L1V1-](#)
[507003V500000](#) [BXRE-30E2000-C-83](#) [BXRE-27E1000-C-83](#) [BXRE-27G0800-D-83](#) [BXRE-50C2001-C-84](#) [BXRH-35S1001-B-73](#) [BXRH-](#)
[30E0300-B-83](#) [BXRH-30E1000-G-83](#) [115780](#) [LM1311D4W-12B4C12\(Ra4\)-DS](#) [ELJU\(9\)-K40M3-0LTHE-R4000](#) [ELJU\(9\)-K40M3-0LTHE-](#)
[R3000](#) [LM1311D4W-12B2C24\(Ra4\)-DS](#) [KW2 CFLNM2.TK-D2D9-4L07M0-SC6B](#) [XEGAWT-H2-0000-000-00000UT122G](#) [XHP35B-H0-](#)
[0000-0D0ZA230G](#) [XHP35B-H0-0000-0D0ZA440G](#) [XHP35B-H0-0000-0D0ZA227G](#) [XHP35B-H0-0000-0D0ZA235G](#) [CTM-9-4018-90-36-](#)
[TWD6-F3-3](#) [CVM-32-56-95-54-AC00-F2-2](#) [SST-12-W65S-A120-H4652](#) [CXM-4-24-90-18-AC40-F5-2](#) [CXM-4-22-90-18-AC40-F5-2](#) [CTM-](#)
[14-4018-90-36-TWD6-F3-3](#) [LM002H384W-7B3C12\(Ra5\)\(ANSI-2700K\)](#) [LM002H384W-9B4C12\(Ra2\)\(ANSI-2700K\)](#) [LM002H384W-](#)
[7B3C12\(Ra7\)\(ANSI-2700K\)](#) [LM002H384W-9B4C12\(Ra2\)\(ANSI-3000K\)](#) [LM002H384W-9B4C12\(Ra4\)-S\(ANSI-3500K\)](#) [LM002H384W-](#)
[9B4C12\(Ra5\)\(ANSI-4000K\)](#) [LM002H384W-7B3C12\(Ra2\)-S\(ANSI-3000K\)](#) [LM002H384W-7B3C12\(Ra5\)\(ANSI-4000K\)](#) [LM002H384W-](#)
[7B3C12\(Ra7\)\(ANSI-4000K\)](#) [HL-LM002H384W-5B2C5\(Ra4\)\(ANSI-3000K\)](#) [HL-LM002H384W-7B1C18\(Ra4\)\(ANSI-6000K\)](#)
[LM002H384W-7B3C12\(Ra5\)\(ANSI-3500K\)](#) [HL-LM002H384W-5B2C5\(Ra4\)\(ANSI-4000K\)](#) [HL-LM002H384W-5B2C5\(Ra4\)\(ANSI-6000K\)](#)