

**RoHS**

# Specification

Client Name:

客户名称: \_\_\_\_\_

Client P/N:

客户品号: \_\_\_\_\_

Product P/N:

**HL-LM002H384W-9B4C12(Ra5)**

产品型号: \_\_\_\_\_

Sending Date: \_\_\_\_\_

| Client approval<br>客户审核  |   | Hongli approval<br>鸿利智汇审核  |             |                    |
|--|---|--|-------------|--------------------|
| Approval<br>核准   | Audit<br>确认                                   | Approval<br>核准   | Audit<br>确认 | Confirmation<br>制作 |
|  |   |  |             | 陈晓彬                |
| <input type="checkbox"/> Qualified<br>qualified<br>接受<br><br><input type="checkbox"/> Dis-qualified<br>不接受 | <input type="checkbox"/> Dis-qualified<br>不接受 | DATE:<br>日期:   |             |                    |

Factory: No. 1, XianKe Yi Road, Huadong town, Huadu district, Guangzhou, China

地址: 中国广州市花都区花东镇先科一路1号

Tel/电话: 020-37705135

Fax/传真: 020-37705136

注: 1. 此规格书以中英文方式书写, 若有冲突以中文版本为准文本.

2. 此规格书的最终解释权归广州市鸿利光电股份有限公司

3. 此规格书的有效期限为两年, 自盖章或签字之日起计算, 期满时双方可以续签协议, 但应采用书面形式

## 1. Part code 产品型号命名原则

LM 002 H384 W - 9 B4 C12 (Ra5)

① ② ③ ④ ⑤ ⑥ ⑦ ⑧



① Product line code 产品系列代码

② Product code base plate 产品基板代码

③ Chip code 芯片代码

④ Emitting light colors 发光颜色

⑤ Recommend the minimum Power  
建议使用的最小功率

⑥ The number of parallel Circuit 并联电路数

⑦ The number of series Circuit 串联电路数

⑧ CRI 显色指数

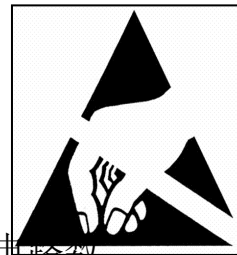

**ATTENTION**注意  
OBSERVE PRECAUTIONS  
FOR HANDLING  
ELECTROSTATIC  
DISCHARGE  
SENSITIVE  
DEVICES  
请勿裸手接触器件

## 2.Features 特点

- Dimension 13.5mm×13.5mm×1.6mm  
尺寸13.5mm×13.5mm×1.6mm
- CRI: Ra 95 显色指数: 95
- Wide viewing angle : 120° 发光角度:  
120°
- RoHS compliant (ROHS标准)
- sulphation corrosion resistance 抗硫化

## 3.Applications 应用

- Down light 筒灯
- Spotlight 射灯

## 4.Package Dimensions 封装尺寸

Tolerance unless otherwise specified: ±0.3mm.

尺寸公差为±0.3毫米除非另有说明

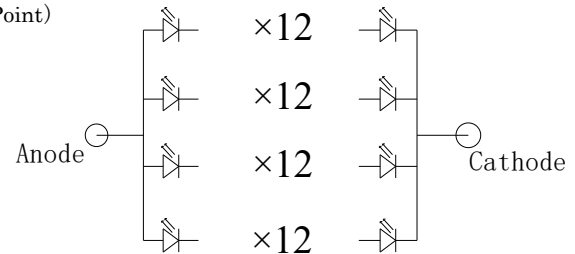
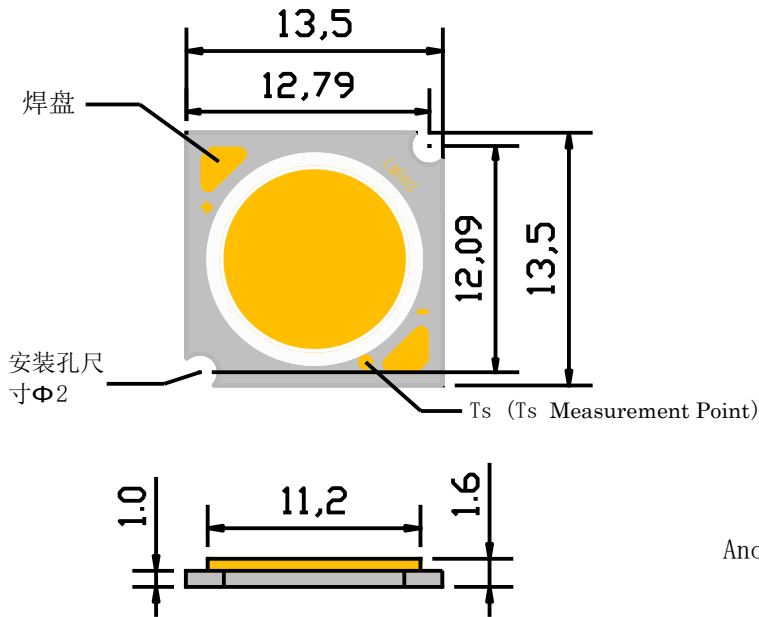

## 5.Performance 性能

### (1) Absolute Maximum Ratings 绝对最大额定值

| Parameter参数                       | Symbol符号         | Min.                     | Typ. | Max. | Units单位 |
|-----------------------------------|------------------|--------------------------|------|------|---------|
| Input power range 输入功率范围          | Pi               | -                        | 12.4 | 17.5 | W       |
| operating current range 工作电流范围    | IF               | -                        | 350  | 480  | mA      |
| Parameter参数                       | Symbol符号         | Rating Value值            |      |      | Units单位 |
| Junction Temperature结温            | Tj               | 120                      |      |      | °C      |
| Operating Temperature Range工作温度   | Top              | -35°C To +80°C           |      |      |         |
| Storage Temperature Range储藏温度     | Tstg             | -40°C To +80°C           |      |      |         |
| Lead Soldering Temperature*引线焊接温度 | T <sub>SOL</sub> | Max. 350°C for 5sec Max. |      |      |         |

Notes for Table:

1.The temperature of Aluminum PCB do not exceed **85°C**. If the input power reach 80% max Pi, the temperature of Aluminum PCB should be control below **75°C**

基板负极引线温度不能超过**85°C**. 如果输入功率达到最大输入功率的80%以上, 基板负极引线温度应控制在**75°C**以内.

2.When hand soldering, keep the temperature of iron below less **350°C less than 5seconds**

当手工焊接时, 烙铁的温度必须**小于350°C**, 时间**不能超过5秒**

3.D.C. Current :  $T_j = T_s + R_{j-s} \times P_i$

## (2) Electro-Optical Characteristics at Tc=25°C

| Parameter参数              | Symbol符号 | Condition 条件 | Min. | Typ. | Max. | LM/W (typ) | Unit 单位 |
|--------------------------|----------|--------------|------|------|------|------------|---------|
| Forward Voltage<br>正向电压  | VF       | IF=350mA     | 34   | 37   | 40   | —          | V       |
| Luminous Flux<br>光通量     | Φv       | TC=2500K     | 950  | 1030 | 1160 | 86         | Lm      |
|                          |          | TC=2700K     | 1080 | 1160 | 1290 | 90         |         |
|                          |          | TC=3000K     | 1100 | 1180 | 1310 | 91         |         |
|                          |          | TC=3500K     | 1200 | 1280 | 1400 | 102        |         |
|                          |          | TC=4000K     | 1300 | 1400 | 1530 | 108        |         |
|                          |          | TC=5000K     | 1260 | 1340 | 1460 | 104        |         |
|                          |          | TC=5700K     | —    | —    | —    | —          |         |
|                          |          | TC=6000±300K | 1250 | 1320 | 1450 | 100        |         |
| CRI 显色指数                 | Ra       | IF=350mA     | 95   | —    | —    | —          | —       |
| Thermal Resistance<br>热阻 | R (j-s)  | IF=350mA     | —    | 2.24 | —    | —          | °C/W    |

## 6.Product bins 产品分级

### Chromaticity bins

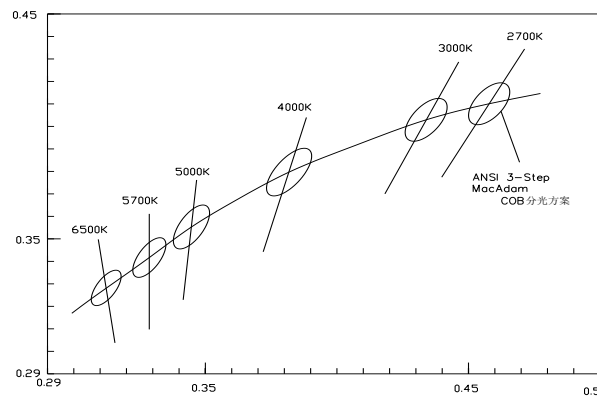

| Center TC | 2725K          | 3045K         | 3985K          | 5028K          | 5665K         | 6530K          |
|-----------|----------------|---------------|----------------|----------------|---------------|----------------|
| X, Y      | 0.4578, 0.4101 | 0.4338, 0.403 | 0.3818, 0.3797 | 0.3447, 0.3553 | 0.329, 0.3417 | 0.3123, 0.3282 |

Notes for Table

\*1. Color bins are defined at IF=350mA operation. If use different forward current, it will cause the change of chromaticity and forward voltage.

该产品通过瞬态350mA 点亮，分光分色。若使用不同电流，会引起色温及电压的变化

\*2. The tolerance of measurement at our tester is VF±3% , Φv±10% and Ra±2.

测试仪测量的公差在电压±3%，流明±10% 和显指±2。

3. Tolerance of ±0.005 on x,y coordinates.

色坐标的测量误差允许在±0.005

4. Color region stay within MacAdam "3-step" ellipse from the chromaticity center. but does not contain the color temperature 6000±300K. The chromaticity center refers to ANSI C78.377-2008.

色域可控制在色温中心坐标的3阶麦克亚当椭圆之内，但不包括色温6000±300K，色温分bin参考ANSI C78.377-2008。



|                   |   |
|-------------------|---|
| Under Development |   |
| Mass production   | ● |

## 7.Characteristics特性

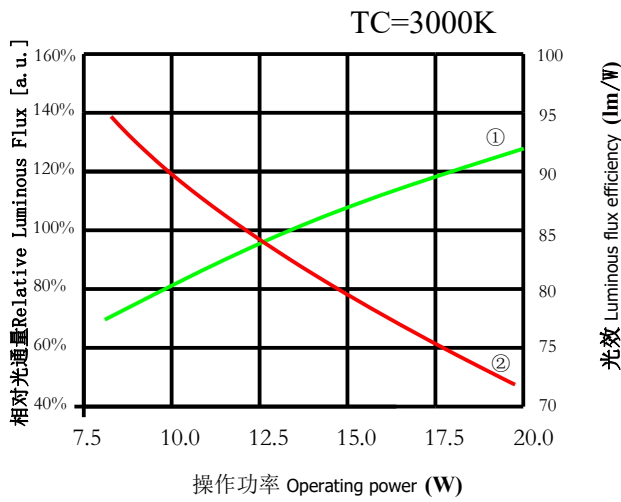

① ——— 操作功率对应相对光通量 ② ——— 操作功率对应光效

Forward Voltage vs. Forward Current  
正向电压与正向电流曲线图

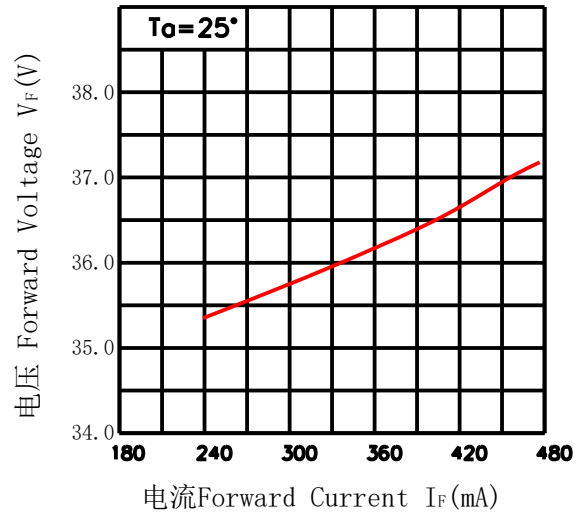

Case Temperature vs. Forward Voltage  
结点温度与正向电压曲线图 IF=350mA

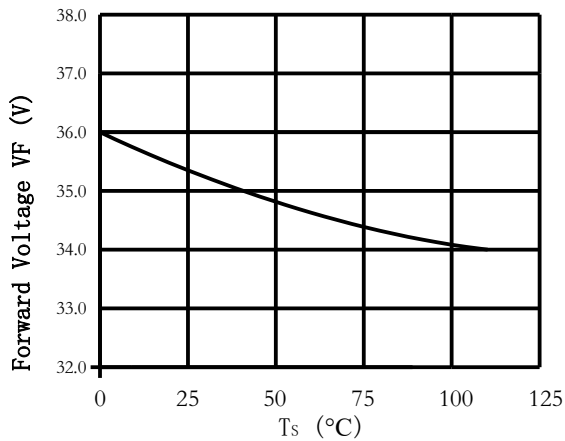

Case Temperature vs. Relative Luminous Flux  
结点温度与相对流明曲线图 IF=350mA

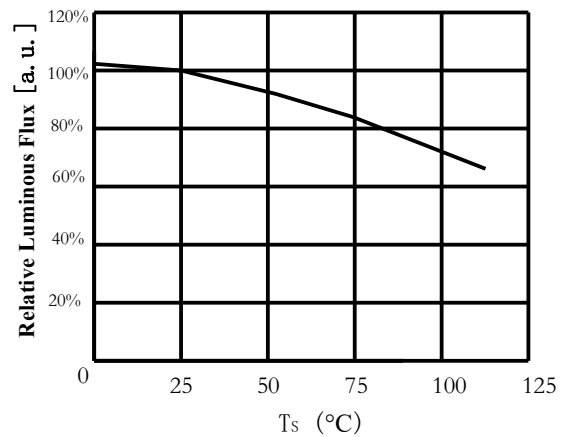

## 8.Packing Specifications 包装规格

|   |      |   |
|---|------|---|
|  <b>HONGLITRONIC</b><br>鸿利光电 |      |  |
| TYPE:   |      | QTY:  |
| VF:   | IF:  | ΦV:   |
| TC:   | X/Y: |   |
| SDCM<   | Ra:  |   |
| DATE:   |      | LOT.NO:   |

Label on ESD shielding 静电袋上标签

|   |                   |   |
|---|-------------------|---|
|  <b>HONGLITRONIC</b><br>鸿利光电 |                   | 成品标示卡<br>(Product Identity Card)<br> |
| 品名(Description):  | High Power LEDs   |   |
| 产品型号(Type):   | XXXXXXXX XXXXXXXX |   |
| 发光颜色(Color):  | XXXXXX            |   |
| 数量(QTY):  | XXXXK             |   |
| 生产批号(LOT NO):   | XXXXXXXX XXXXXXXX |   |
| 出货日期(Date):   | XXXX.XX.XX        |   |
| 操作员(Operator):  | XXXX              |   |

Label on box 外箱标签

ΦV: Luminous Flux rank 光通量档次范围

VF: Forward voltage rank 正向电压档次范围

TC: Color temperature 色温

SDCM:相对色容差

### ■ Packing figure 包装图

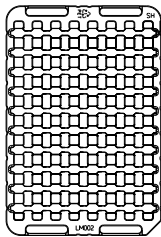

Tray: 80pcs

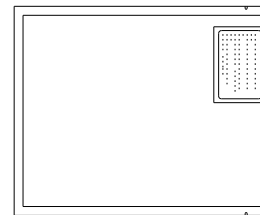
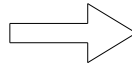

6Tray/ESD Shilding Bag:480pcs

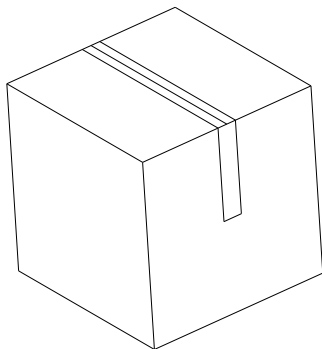
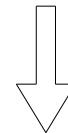

4Inner Box/Outer Box:3840pcs  
L\*W\*H=400\*285\*373mm

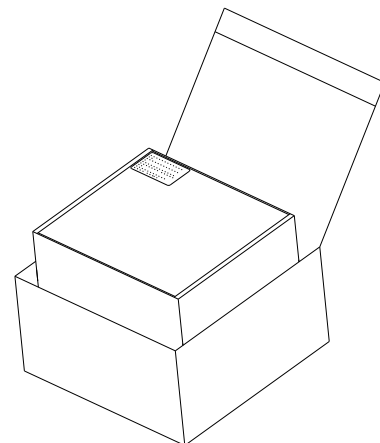
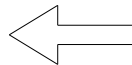

2ESD Shilding Bag/Inner Box:960pcs  
L\*W\*H=364\*260\*84 mm

## Precaution for use (防护措施)

### 1. Storage 储存

To avoid moisture, we recommend storage conditions for the unopened LED +5 ~ +30 °C, relative humidity <60%. LED should be used within 168 Hrs. of opening the package. Please make sure to dehumidify and vacuum pack the remaining/ unused LED. Dehumidifying condition: +120 °C ± 5 °C, 04 Hrs. Effective age for the sealed led is one year. 为避免受潮的影响，我司建议产品在未开包装前储存条件为 5-30° C，相对湿度小于 60%。已开包装的 LED 光源请在 168H 内使用安装完毕，如未用完之产品，请进行除湿并抽真空后密封保存。除湿条件：120° C ± 5° C，4H。产品密封保存有效使用期为一年。

### 2. The soldering precautions 组装注意事项：

Soldering conditions: Reflow soldering is not recommended for this LED. If hand soldering, set soldering iron temperature at 350°C and soldering time not More than 5 seconds, after the first soldering, make sure the substrate surface temperature returns to ambient temperature before a second soldering. Please make sure when soldering, there is no external force on the soldering surface and silicon batardeau (such as pressure, friction or sharp metal nails, etc.), to avoid gold wire deformation or damage and other abnormalities. If beyond recommended conditions, we cannot guarantee the LED stability, please do the risk assessment first.

During assembly, please ensure that a good quality thermal paste is applied and distributed evenly over the surface. While using thermal pad (Heat Sink), make sure LED is firmly tightened and there is no gap between surfaces. In such heat-media products, through a pressure test of at least 500 volts. 焊接条件：此产品不推荐使用回流焊接的作业方式，手工焊接烙铁温度设定 350° C，焊接时间不可超过 5 秒，第一焊点焊接后请确保基板表面温度恢复到环境温度，方可进行第二次的焊接。焊接时请注意不可有外力作用于胶体表面及外圈的围堰胶上（如压力，摩擦或锋利金属钉等），以免造成金线变形或断线等异常；如果超出此使用条件，鸿利光电将不能保证产品的稳定性，如需使用超出的操作条件，请务必进行风险评。

为确保在组装时降低接触热阻，请注意导热膏涂布均匀且分布面积合理，不可出现导热膏太少或涂抹高低不平等现象。如使用导热胶垫时，请确保螺丝安装后基板与导热胶垫的完全接触，不可存在中空现象。产品在此类耐热介质下，能通过至少500伏的耐压测试。

### 3. Anti-Static Measures 防静电措施：

Please take adequate measures to prevent electrostatic generation, such as wearing electrostatic ring or anti-static fingerstall etc; any relative products like plant equipment, machinery, carrier and transportation units shall be connected to discharging unit/ ground. The ESD sensitivity of this product is > 1000V, after assembly the final lamp, please make sure to discharge Static Electricity by proper ESD equipment. 请采取足够的措施来防止静电产生，比如带静电环或防静电手指套等；每个制造厂关于产品（工厂、设备、机器、载波机和运输单位）应当连接到底面，请避免产品电气带电；本产品的防静电敏感度超过1000V，装配后的最终灯具产品（S）建议检查是否损坏LED（漏电现象）。

#### 4. Temperature Control温度控制:

Recommended temperature conditions for enhanced product life: Be sure to TS point (negative pads) controlled below 95 °C, COB recommendation colloid surface temperature control  $\leq 160$  °C.

保证散热前提条件为: 请务必将TS点(负极焊盘)控制在95°C以下, 建议COB胶体表面温度控制 $\leq 160$ °C。

#### 5. The drive control驱动控制: :

Drive this product at constant current. Output current range specifications should be according to the operational and other conditions, as mentioned in data sheet. Before using a constant voltage source or altered specifications other than recommended, please consider risk factors.本产品需使用恒流源进行驱动, 且输出电流符合规格书上的功率使用范围, 如需使用恒压源或其他使用条件, 请进行使用效果风险评估。

#### 6. Other其他:

Product is not suitable to use in following conditions本产品不可在以下条件下使用, 如果产品在以下条件下使用, 评估其使用效果和风险是有必要的:

- Direct or indirect wet / damp conditions, such as rain, etc.;
- 直接或间接的打湿或受潮, 比如淋雨等;
- In contact with sea water and erosive materials
- 被海水损害或侵蚀;
- Exposed to corrosive gases (e.g., Cl<sub>2</sub>, H<sub>2</sub>S, NH<sub>3</sub>, SO<sub>x</sub>, NO<sub>x</sub>, etc.);
- 被暴露于腐蚀性气体(如 Cl<sub>2</sub>, H<sub>2</sub>S、NH<sub>3</sub>、SO<sub>x</sub>、NO<sub>x</sub>等);
- Exposed to dust, liquids or oils;
- 被暴露于粉尘、液体或油;

#### 镜面铝基板防硫化标准:

—COB从出货日起, 灯具硫浓度小于2000PPM, 胶面温度在我司要求范围内。

—灯具硫元素可为硫化物, 不能出现单质硫, 单质硫在高温情况下挥发将引起基板保护层破坏, 发黑。

—Other points for attention, please refer to our LED user manual, In accordance with the user manual, the product shelf life is 24 months, If there is a warranty agreement, the warranty agreement shall prevail

—其它注意事项请参照我们的LED使用手册, 符合使用手册的情况下, 产品质保期为24个月, 有保质协议的则以保质协议为准。

—After the product life cycle for recycling.

—产品生命周期后进行回收处理。





|                   |   |
|-------------------|---|
| Under Development |   |
| Mass production   | ● |

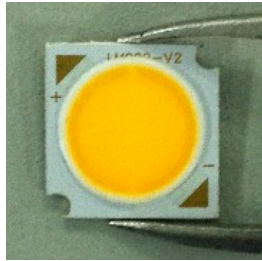

**OK**

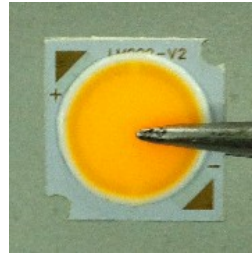

**NG**



| 修订次数 | 修订人 | 修订内容                                    | 修订日期         | 版次  |
|------|-----|---|--------------|-----|
| 1    | 杨亮  | 新增2500K光通量950-1030-1160                 | 2018. 5. 23  |     |
| 2    | 冯广春 | 修改2700光通量1080-1160-1290lm               | 2019. 4. 23  | A/0 |
| 3    | 刘焕聪 | 更新规格书格式                                 | 2020. 03. 11 | A/1 |
| 4    | 苏国强 | 3500K光通量改为1200-1280-1400                | 2020. 6. 24  | A/1 |
| 5    | 苏国强 | 新增3500K光通量1260-1340-1460                | 2021. 9. 16  | A/1 |
| 6    | 莫家强 | 4000K光通量由1200-1270-1400改为1300-1400-1530 | 2022. 9. 27  | A/1 |
| 7    |     |   |              |     |
| 8    |     |   |              |     |
| 9    |     |   |              |     |
| 10   |     |   |              |     |
| 11   |     |   |              |     |
| 12   |     |   |              |     |
| 13   |     |   |              |     |
| 14   |     |   |              |     |
| 15   |     |   |              |     |
| 16   |     |   |              |     |
| 17   |     |   |              |     |
| 18   |     |   |              |     |
| 19   |     |   |              |     |
| 20   |     |   |              |     |
| 21   |     |   |              |     |
| 22   |     |   |              |     |
| 23   |     |   |              |     |
| 24   |     |   |              |     |
| 25   |     |   |              |     |
| 26   |     |   |              |     |

## X-ON Electronics

Largest Supplier of Electrical and Electronic Components

*Click to view similar products for [High Power LEDs - White category:](#)*

*Click to view products by [HONGLITRONIC manufacturer:](#)*

Other Similar products are found below :

[LTW-K140SZR40](#) [LTPL-P00DWS57](#) [LTW-K140SZR30](#) [LZP-D0WW00-0000](#) [LTW-K140SZR57](#) [LTW-K140SZR27](#) [BXRC-35E10K0-D-73](#)  
[MP-5050-6100-65-80](#) [KW CSLPM2.CC-8L8M-4L8N](#) [KW CSLPM2.CC-8L8M-4O9Q](#) [KW DPLS32.SB-6H6J-E5P7-EG-Z264](#) [L1V1-](#)  
[507003V500000](#) [BXRE-30E2000-C-83](#) [BXRE-27E1000-C-83](#) [BXRE-27G0800-D-83](#) [BXRE-50C2001-C-84](#) [BXRH-35S1001-B-73](#) [BXRH-](#)  
[30E0300-B-83](#) [BXRH-30E1000-G-83](#) [115780](#) [LM1311D4W-12B4C12\(Ra4\)-DS](#) [ELJU\(9\)-K40M3-0LTHE-R4000](#) [ELJU\(9\)-K40M3-0LTHE-](#)  
[R3000](#) [LM1311D4W-12B2C24\(Ra4\)-DS](#) [KW2 CFLNM2.TK-D2D9-4L07M0-SC6B](#) [XEGAWT-H2-0000-000-00000UT122G](#) [XHP35B-H0-](#)  
[0000-0D0ZA230G](#) [XHP35B-H0-0000-0D0ZA440G](#) [XHP35B-H0-0000-0D0ZA227G](#) [XHP35B-H0-0000-0D0ZA235G](#) [CTM-9-4018-90-36-](#)  
[TWD6-F3-3](#) [CVM-32-56-95-54-AC00-F2-2](#) [SST-12-W65S-A120-H4652](#) [CXM-4-24-90-18-AC40-F5-2](#) [CXM-4-22-90-18-AC40-F5-2](#) [CTM-](#)  
[14-4018-90-36-TWD6-F3-3](#) [LM002H384W-7B3C12\(Ra5\)\(ANSI-2700K\)](#) [LM002H384W-9B4C12\(Ra2\)\(ANSI-2700K\)](#) [LM002H384W-](#)  
[7B3C12\(Ra7\)\(ANSI-2700K\)](#) [LM002H384W-9B4C12\(Ra2\)\(ANSI-3000K\)](#) [LM002H384W-9B4C12\(Ra4\)-S\(ANSI-3500K\)](#) [LM002H384W-](#)  
[9B4C12\(Ra5\)\(ANSI-4000K\)](#) [LM002H384W-7B3C12\(Ra2\)-S\(ANSI-3000K\)](#) [LM002H384W-7B3C12\(Ra5\)\(ANSI-4000K\)](#) [LM002H384W-](#)  
[7B3C12\(Ra7\)\(ANSI-4000K\)](#) [HL-LM002H384W-5B2C5\(Ra4\)\(ANSI-3000K\)](#) [HL-LM002H384W-7B1C18\(Ra4\)\(ANSI-6000K\)](#)  
[LM002H384W-7B3C12\(Ra5\)\(ANSI-3500K\)](#) [HL-LM002H384W-5B2C5\(Ra4\)\(ANSI-4000K\)](#) [HL-LM002H384W-5B2C5\(Ra4\)\(ANSI-6000K\)](#)