

技术参数 SPECIFICATIONS

- 线数 (Poles) : 2~12(17)
- 适用线规 (Applicable wires) : AWG24#~18#
- 适应基板厚度 (Applicable PC board thickness) : 1.6mm
- 温度范围 (Temperature range) : -25℃~85℃
- 额定电压 (Voltage rating) : 250V.Ac/Dc
- 额定电流 (Current rating) : 5A
- 接触电阻 (Contact resistance) : ≤0.015Ω
- 绝缘电阻 (Insulation resistance) : ≥1000MΩ
- 耐压 (Withstand voltage) : 1500V.Ac/1min
- 材料 (Material) :
 - 孔座 (Housing) : 尼龙 (PA66) UL94V-2(0)
 - 针座 (Wafer) : 尼龙 (PA66) UL94V-2(0)
 - 端子 (Terminal) : 磷青铜 (Phos.bronze Tin/plated)

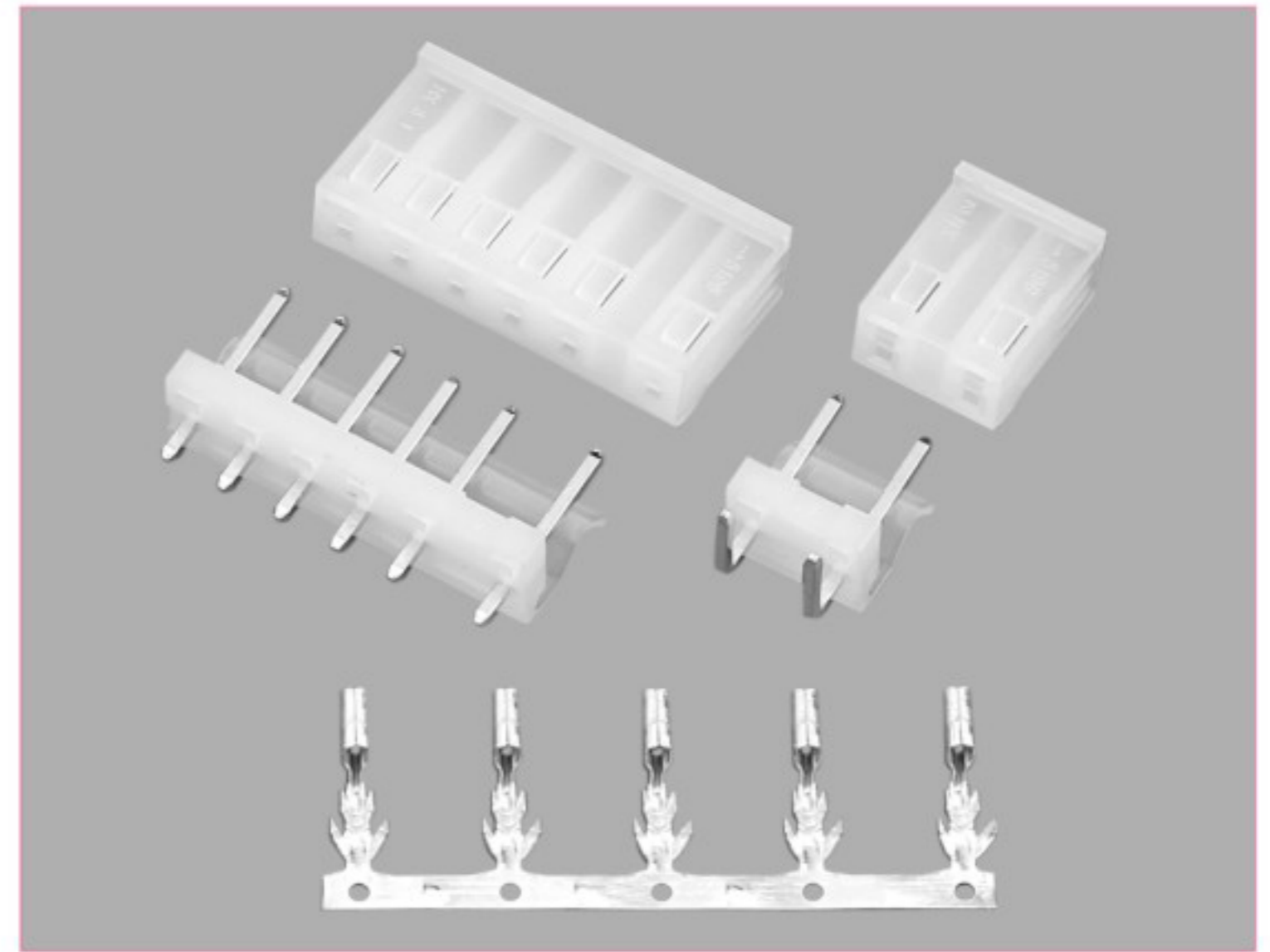

端子 TERMINAL (5225、5194)

型号 Type	适用线规 Applicable wires		电线外径 O.D of wire ins mm	数量 Quantity
	mm ²	AWG#		
HX39606-PT	0.2~0.75	24~18	1.5~2.8	3500PCS/盘

HX39606-PT (5225、5194)

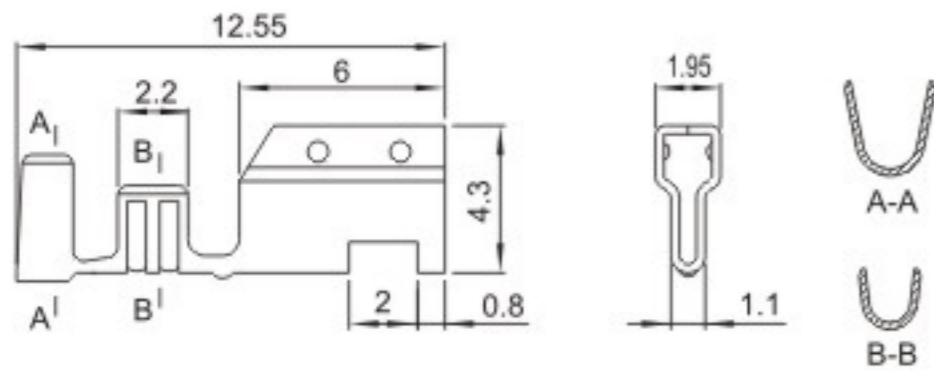

HX39607-Y (5196)

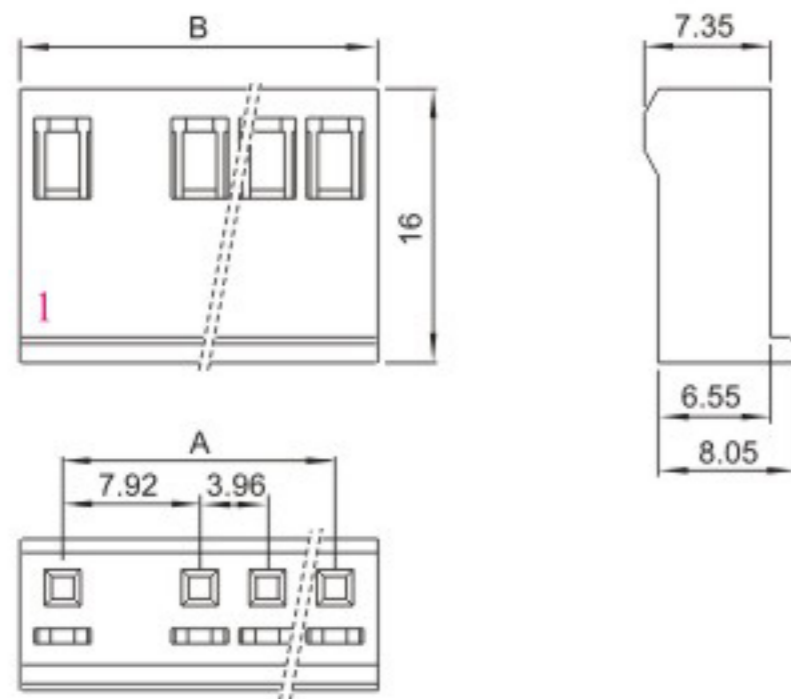

HX39607-NA (5275/5196)

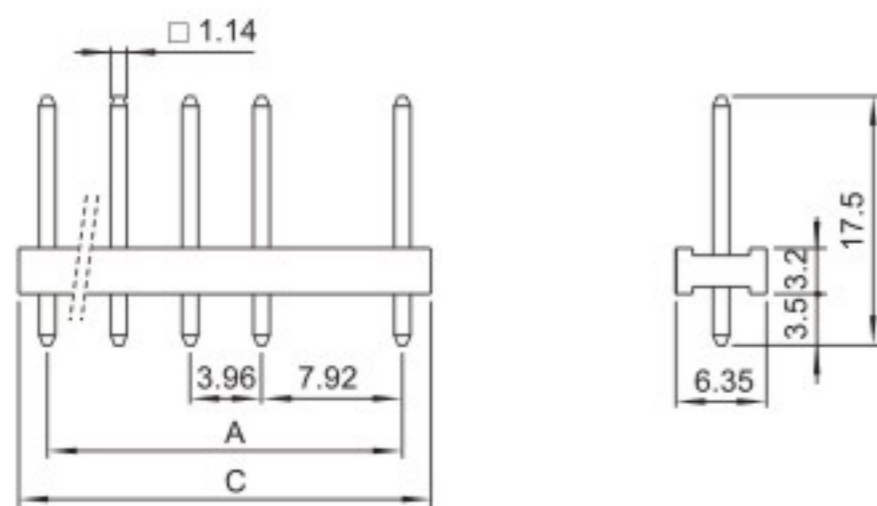

HX39607-A (5277/5196)

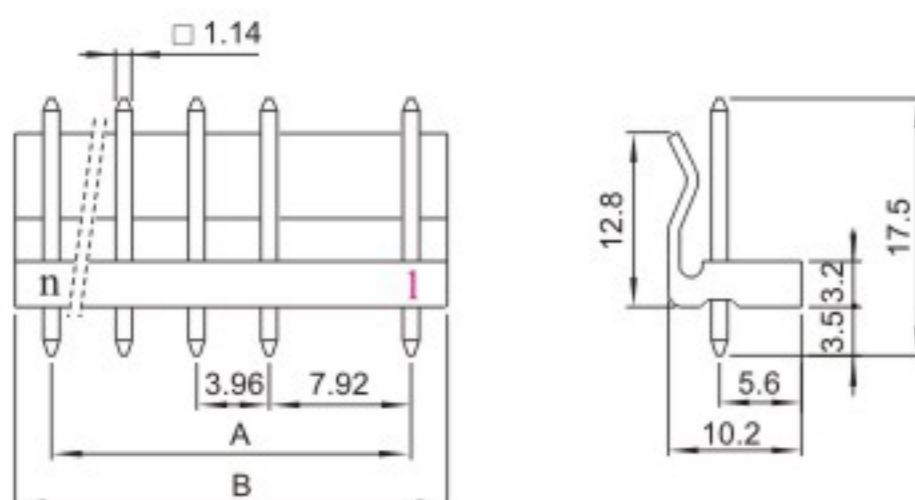

HX39607-WAP (5277/5196)

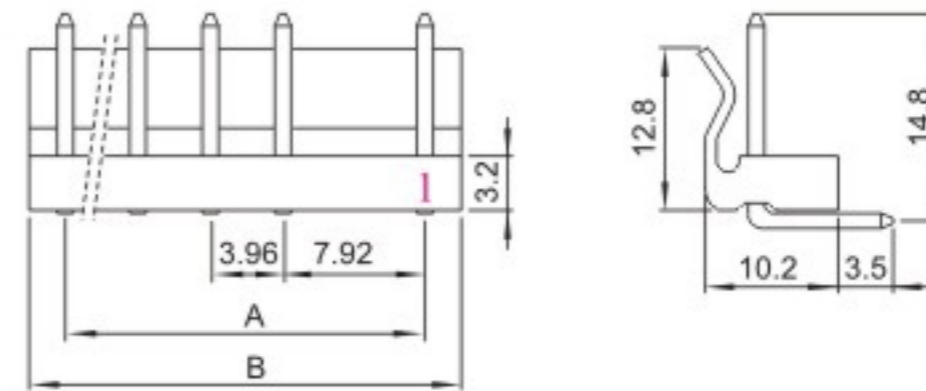

HX39607-WAG (5277/5196)

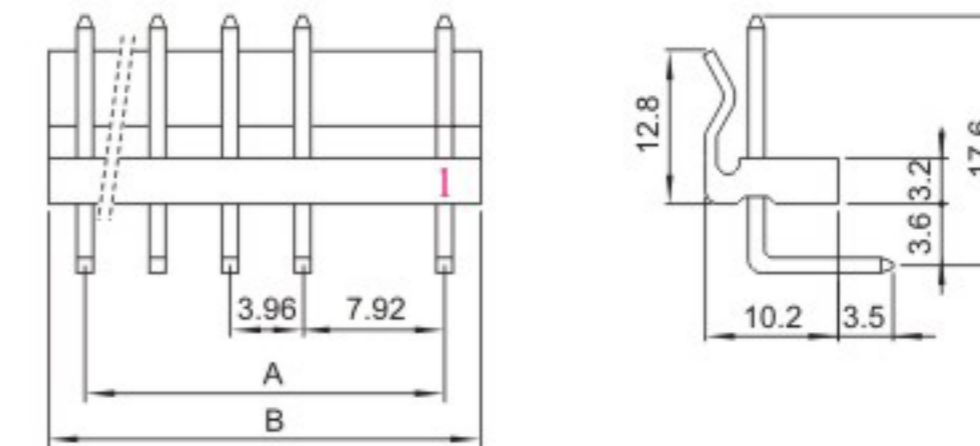

注: 5196-A针座=3.96-A空第二针(如5196-3A=3.96-4A3针空2)

安装尺寸 MOUNTING MEASUREMENT

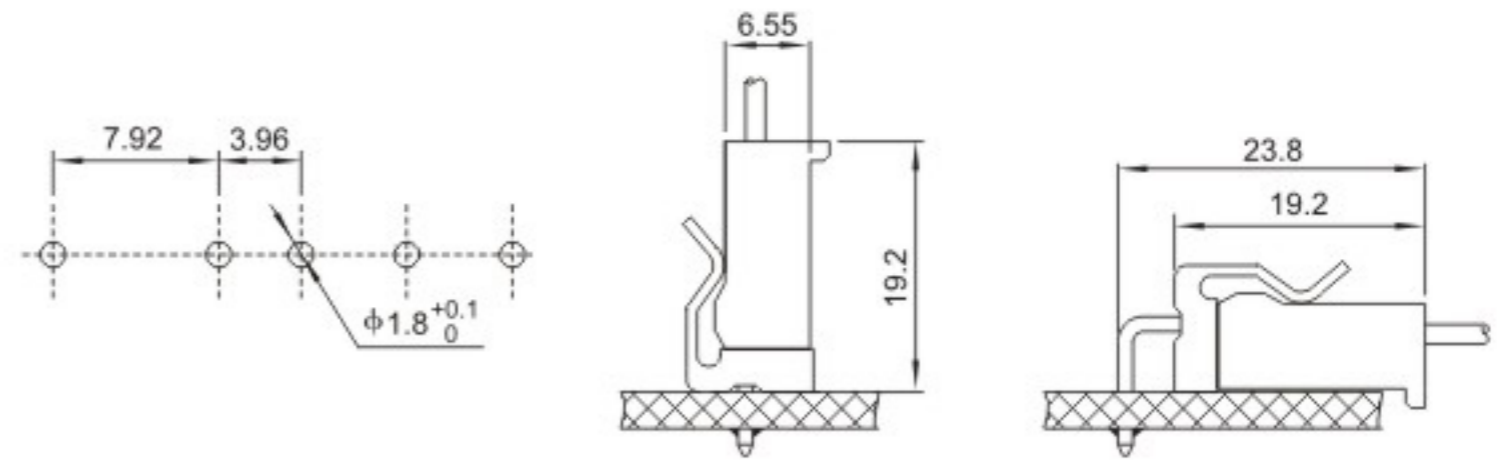

孔座 HOUSING (5196)

线数 Poles	型号 Type	尺寸 Dimensions(mm)	
		A	B
2	HX39607-2Y	7.92	13.02
3	HX39607-3Y	11.88	16.98
4	HX39607-4Y	15.84	20.94
5	HX39607-5Y	19.80	24.91
6	HX39607-6Y	23.76	28.86
7	HX39607-7Y	27.72	32.82
8	HX39607-8Y	31.68	36.78
9	HX39607-9Y	35.64	40.74
10	HX39607-10Y	39.60	44.70
11	HX39607-11Y	43.56	48.66
12	HX39607-12Y	47.52	52.62
...
17	HX39607-17Y	67.32	72.42

针座 WAFER (5275/5277/5196)

线数 Poles	型号 Type		尺寸 Dimensions(mm)		
	直式/弯式	横条(180°)	A	B	C
2	HX39607-2A/WA	HX39607-2NA	7.92	11.88	11.73
3	HX39607-3A/WA	HX39607-3NA	11.88	15.84	15.69
4	HX39607-4A/WA	HX39607-4NA	15.84	19.80	19.65
5	HX39607-5A/WA	HX39607-5NA	19.80	23.76	23.61
6	HX39607-6A/WA	HX39607-6NA	23.76	27.72	27.57
7	HX39607-7A/WA	HX39607-7NA	27.72	31.68	31.53
8	HX39607-8A/WA	HX39607-8NA	31.68	35.64	35.49
9	HX39607-9A/WA	HX39607-9NA	35.64	39.60	39.45
10	HX39607-10A/WA	HX39607-10NA	39.60	43.56	43.41
11	HX39607-14A/WA	HX39607-11NA	43.56	47.52	47.37
12	HX39607-14A/WA	HX39607-12NA	47.52	51.48	51.33
...	...	---	---
17	HX39607-17A/WA	---	67.32	71.28	---

X-ON Electronics

Largest Supplier of Electrical and Electronic Components

Click to view similar products for [Headers & Wire Housings](#) category:

Click to view products by [Hongxing](#) manufacturer:

Other Similar products are found below :

[57102-F02-18ULF](#) [58102-G61-06LF](#) [0009485154](#) [009176003701906](#) [0050291907](#) [02.125.8002.8](#) [609-3404](#) [61062-3](#) [622-0430](#) [622-3653LF](#)
[63453-116](#) [636-1030](#) [636-1427](#) [636-3427](#) [636-4007](#) [641938-9](#) [644827-2](#) [65495-038](#) [65692-001LF](#) [65781-018](#) [65781-047](#) [65817-010LF](#)
[65817-015LF](#) [66207-023LF](#) [67016-026LF](#) [67095-007LF](#) [68631-112](#) [68645-018](#) [68648-049](#) [699319-000](#) [70.362.1628.0](#) [70-4210](#) [70-4226B](#)
[70-4853B](#) [707-5020](#) [707-5028](#) [71.350.2428.0](#) [71961-016LF](#) [733-134](#) [754199-000](#) [760-3052](#) [787-8014-00](#) [FCN-367T-T012/H](#) [80.063.4001.1](#)
[800-90-001-10-001000](#) [800-90-010-10-002000](#) [801-43-002-10-013000](#) [801-43-006-10-002000](#) [803-41-018-10-001000](#) [803-43-014-20-001000](#)