

技术参数 SPECIFICATIONS

- 线数 (Poles) : 1、2、3、4、6、8、9、12、15、16
- 适用线规 (Applicable wires) : AWG28#~18#
- 适应基板厚度 (Applicable PC board thickness) : 0.7~2.0mm
- 温度范围 (Temperature range) : -25℃~85℃
- 额定电压 (Voltage rating) : 300V.Ac/Dc
- 额定电流 (Current rating) : 10A Max
- 接触电阻 (Contact resistance) : ≤0.015Ω
- 绝缘电阻 (Insulation resistance) : ≥1000MΩ
- 耐压 (Withstand voltage) : 1500V.Ac/1min
- 材料 (Material) :
 - 插头 (Plug housing) : 尼龙 (PA66) UL94V-0
 - 插座 (Receptacle housing) : 尼龙 (PA66) UL94V-0
 - 插片 (Retainer) : 尼龙 (PA66) UL94V-2
 - 端子 (Terminal) : 磷青铜 (Phos.bronze Tin/plated)
 - 黄铜 (Brass Tin/plated)

端子 TERMINAL (YL)

型号 Type	适用线规 Applicable wires		电线外径 O.D of wire ins mm	数量 Quantity
	mm ²	AWG#		
HX45004-01PT	0.09~0.3	28~22	0.9~1.7	5000PCS/盘
HX45005-01RT	0.09~0.3	28~22	0.9~1.7	5000PCS/盘
HX45004-21PT	0.3~0.75	22~18	1.7~3.0	4000PCS/盘
HX45005-21RT	0.3~0.75	22~18	1.7~3.0	4000PCS/盘

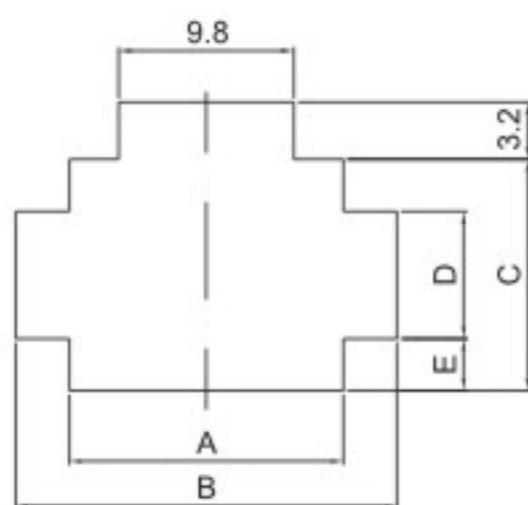

安装尺寸 MOUNTING MEASUREMENT

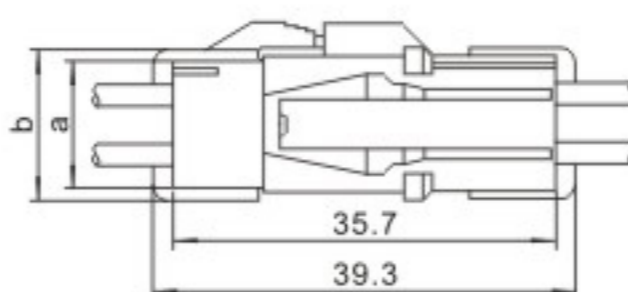

型号 Type	线数 Poles	尺寸 Dimensions W (mm)	
		a	b
单排	2、3	9.5	10.8
2排	4、6、8、12、16	15.3	16.6
3排	9、12、15	20.5	21.8

线数 Poles	型号 Type	适应基板厚度(Applicable PC board thickness)(mm)								
		0.7~2.0			0.7~0.8		0.9~1.3		1.4~2.0	
		A	B	C	D	E	D	E	D	E
2	HX45005-2R	10.7	16.8	7.1	4.4	1.3	5.0	1.0	5.6	0.7
3	HX45005-3R	15.3	21.3	7.1	4.4	1.3	5.0	1.0	5.6	0.7
4	HX45005-4R	10.7	16.8	12.9	7.1	2.85	7.7	2.55	8.3	2.25
6	HX45005-6R	15.3	21.3	12.9	7.1	2.85	7.7	2.55	8.3	2.25
8	HX45005-8R	19.8	25.8	12.9	7.1	2.85	7.7	2.55	8.3	2.25
9	HX45005-9R	15.3	21.3	18.2	7.1	5.55	7.7	5.25	8.3	4.95
12(3X4)	HX45005-12R	19.8	25.8	18.2	7.1	5.55	7.7	5.25	8.3	4.95
12(2X6)	HX45005-12RN	28.9	34.8	12.9	7.1	2.85	7.7	2.55	8.3	2.25
15	HX45005-15R	24.4	30.3	18.2	7.1	5.55	7.7	5.25	8.3	4.95
16	HX45005-16R	37.9	43.8	12.9	7.1	2.85	7.7	2.55	8.3	2.25

HX45004-PT (YL)

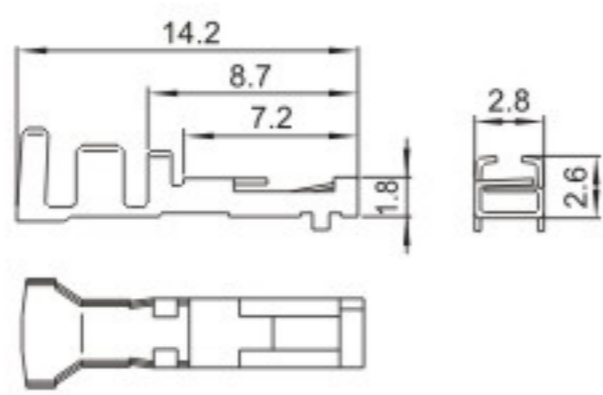

HX45005-RT (YL)

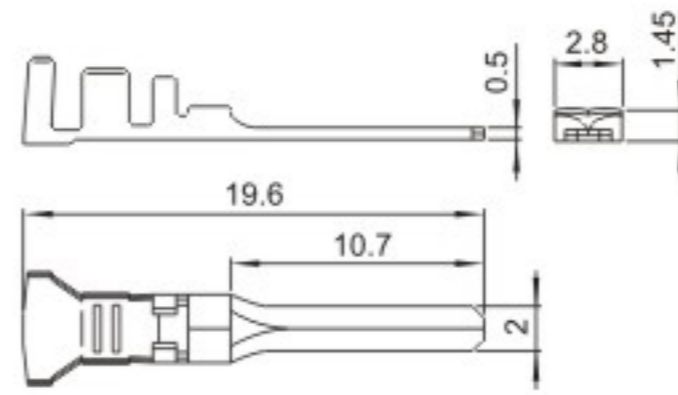

线数 (Poles)	额定电压 (Voltage rating)	额定电流 (Current rating)	插头 (Plug Housing)	插座 (Receptacle Housing)	插片 (Retainer)
1	300V	7A (10A)	HX45004-1P (YL) 	HX45005-1RF (YL) 	HX45004-1S (YL)
2	300V	7A (10A)	HX45004-2P (YL) 	HX45005-2R (YL) 	HX45004-2S (YL)



线数 (Poles)	额定电压 (Voltage rating)	额定电流 (Current rating)	插头 (Plug Housing)	插座 (Receptacle Housing)	插片 (Retainer)
2	300V	7A (10A)	HX45004-2P (YL) 	HX45005-2RF (YL) 	HX45004-2S (YL)
			HX45004-3P (YL) 	HX45005-3R (YL) 	HX45004-3S (YL)
3	300V	6A (9A)	HX45004-4P (YL) 	HX45005-3RF (YL) 	HX45004-3S (YL)
			HX45005-4R (YL) 	HX45004-2S (YL) 	
4	300V	5A (8A)	HX45005-4RF (YL) 	HX45004-2S (YL) 	
			HX45005-4R (YL) 	HX45004-2S (YL) 	

线数 (Poles)	额定电压 (Voltage rating)	额定电流 (Current rating)	插头 (Plug Housing)	插座 (Receptacle Housing)	插片 (Retainer)
6	300V	5A (8A)	HX45004-6P (YL) 	HX45005-6R (YL) 	HX45004-3S (YL)
			HX45005-6RF (YL) 		
8	300V	4A (6A)	HX45004-8P (YL) 	HX45005-8R (YL) 	HX45004-4S (YL)
			HX45005-8RF (YL) 		
9	300V	4A (6A)	HX45004-9P (YL) 	HX45005-9R (YL) 	
			HX45005-9RF (YL) 		
12	300V	3A (6A)	HX45004-12P (YL) 	HX45005-12R (YL) 	
			HX45005-12RF (YL) 		

线数 (Poles)	额定电压 (Voltage rating)	额定电流 (Current rating)	插头 (Plug Housing)	插座 (eceptacle Housing)	插片(Retainer)
12	300V	3A (6A)	<p>HX45004-12PN (YL)</p>	<p>HX45005-12RN (YL)</p>	<p>HX45004-6S (YL)</p>
15	300V	3A (5A)	<p>HX45004-15P (YL)</p>	<p>HX45005-15R (YL)</p>	
16	300V	3A (5A)	<p>HX45004-16P (YL)</p>	<p>HX45005-16R (YL)</p>	<p>HX45004-8S (YL)</p>

X-ON Electronics

Largest Supplier of Electrical and Electronic Components

Click to view similar products for [Headers & Wire Housings](#) category:

Click to view products by [Hongxing](#) manufacturer:

Other Similar products are found below :

[57102-F02-18ULF](#) [58102-G61-06LF](#) [0009485154](#) [009176003701906](#) [0050291907](#) [02.125.8002.8](#) [609-3404](#) [61062-3](#) [622-0430](#) [622-3653LF](#)
[63453-116](#) [636-1030](#) [636-1427](#) [636-3427](#) [636-4007](#) [641938-9](#) [644827-2](#) [65495-038](#) [65692-001LF](#) [65781-018](#) [65781-047](#) [65817-010LF](#)
[65817-015LF](#) [66207-023LF](#) [67016-026LF](#) [67095-007LF](#) [68631-112](#) [68645-018](#) [68648-049](#) [699319-000](#) [70.362.1628.0](#) [70-4210](#) [70-4226B](#)
[70-4853B](#) [707-5020](#) [707-5028](#) [71.350.2428.0](#) [71961-016LF](#) [733-134](#) [754199-000](#) [760-3052](#) [787-8014-00](#) [FCN-367T-T012/H](#) [80.063.4001.1](#)
[800-90-010-10-002000](#) [801-43-002-10-013000](#) [801-43-006-10-002000](#) [803-41-018-10-001000](#) [803-43-014-20-001000](#) [803-43-024-10-001000](#)