

Surface Mount Aluminum Electrolytic Capacitors

GVT 105°C,2000Hrs,Standard Series

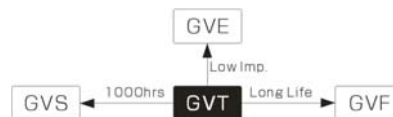

Features

105°C, 2000 hours assured.
Available for high density surface mounting.
High stability and reliability.

Specifications

| Item | Condition | Specifications | | | | | | | | | | |
|---------------------------------|--|--|---|------|------|------|------|------|------|------|--|--|
| Category Temperature Range(°C) | — | -55°C ~ +105°C | | | | | | | | | | |
| Capacitance Tolerance (%) | 120Hz, 20°C | ±20% | | | | | | | | | | |
| Rated Voltage (V) | — | 6.3 | 10 | 16 | 25 | 35 | 50 | 63 | 100 | | | |
| Dissipation Factor (tanδ) | 120Hz, 20°C (Max.) | tanδ | 0.30 | 0.24 | 0.20 | 0.18 | 0.16 | 0.14 | 0.14 | 0.14 | | |
| | | Notes | Exceeding 1,000uF, +0.02 every 1,000uF | | | | | | | | | |
| Leakage Current (LC) | After 2 minutes, 20°C (uA, Max.) | 0.01CV or 3uA, whichever is greater. | | | | | | | | | | |
| Low Temperature Characteristics | Impedance Ratio (Max.) | Z _{-25°C} /Z _{+20°C} | 5 | 4 | 3 | 2 | 2 | 2 | 2 | 2 | | |
| | | Z _{-40°C} /Z _{+20°C} | 10 | 8 | 6 | 4 | 3 | 3 | 3 | 3 | | |
| Endurance | 105°C, Rated Voltage Applied (With the rated ripple current) | Hours | 2,000 | | | | | | | | | |
| | | ΔC/C | Within ±30% of initial value | | | | | | | | | |
| | | tanδ | 300% or less of the initial specified value | | | | | | | | | |
| | | LC | The initial specified value or less | | | | | | | | | |
| Shelf life | 105°C | Hours | 1,000 | | | | | | | | | |
| | | Other Items | same as those for the endurance. | | | | | | | | | |

Dimensions

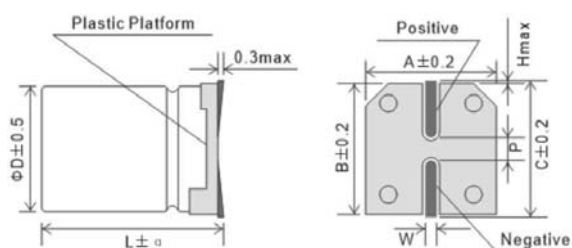

| D | L | A | B | C | P | α | W |
|-----|------|------|------|------|-----|------|---------|
| 4 | 5.7 | 4.3 | 4.3 | 5.0 | 1.0 | ±0.3 | 0.5-0.8 |
| 5 | 5.7 | 5.3 | 5.3 | 6.0 | 1.5 | ±0.3 | 0.5-0.8 |
| 6.3 | 5.7 | 6.6 | 6.6 | 7.3 | 2.0 | ±0.3 | 0.5-0.8 |
| 6.3 | 7.7 | 6.6 | 6.6 | 7.3 | 2.0 | ±0.3 | 0.5-0.8 |
| 8 | 10.5 | 8.3 | 8.3 | 9.0 | 3.1 | ±0.5 | 0.7-1.2 |
| 10 | 10.5 | 10.3 | 10.3 | 11.0 | 4.7 | ±0.5 | 0.7-1.2 |

Rated Ripple Current Multipliers

| Frequency (Hz) | 50 | 120 | 1k | 10k up |
|------------------|------|------|------|--------|
| Capacitance (uF) | | | | |
| Under 100 | 0.70 | 1.00 | 1.35 | 1.50 |
| 100 ~ 2200uF | 0.80 | 1.00 | 1.20 | 1.30 |

GVT

 Series

■ Dimensions

| uF | WV | 6.3v (0J) | | 10v (1A) | | 16v (1C) | | 25v (1E) | | 35v (1V) | | 50v (1H) | | 63v (1J) | | 100v (2A) | |
|------|---------|-----------|---------|----------|---------|----------|---------|----------|---------|----------|---------|----------|---------|----------|---------|-----------|------|
| | | ΦD x L | R.C. | ΦD x L | R.C. | ΦD x L | R.C. | ΦD x L | R.C. | ΦD x L | R.C. | ΦD x L | R.C. | ΦD x L | R.C. | ΦD x L | R.C. |
| 1.0 | | | | | | | | | | | | 4x5.7 | 7 | 4x5.7 | 7 | 4x5.7 | 7 |
| 2.2 | | | | | | | | | | | | 4x5.7 | 11 | 4x5.7 | 11 | 4x5.7 | 9 |
| 3.3 | | | | | | | | | | 4x5.7 | 13 | 4x5.7 | 13 | 5x5.7 | 13 | 5x5.8 | 14 |
| 4.7 | | | | | | | | 4x5.7 | 13 | 4x5.7 | 14 | 4x5.7 | 13 | 5x5.7 | 16 | 5x5.8 | 16 |
| 6.8 | | | | | | | | 4x5.7 | 14 | 4x5.7 | 14 | 4x5.7 | 14 | 5x5.7 | 17 | 6.3x5.7 | 21 |
| 10 | | | | | | 4x5.7 | 18 | 4x5.7 | 14 | 4x5.7 | 14 | 5x5.7 | 18 | 5x5.7 | 19 | 6.3x5.7 | 35 |
| 22 | | | | 4x5.7 | 20 | 4x5.7 | 20 | 4x5.7 | 19 | 5x5.7 | 30 | 6.3x5.7 | 42 | 6.3x5.7 | 40 | 6.3x7.7 | 60 |
| 33 | 4x5.7 | 22 | 4x5.7 | 22 | 4x5.7 | 22 | 4x5.7 | 22 | 5x5.7 | 34 | 6.3x5.7 | 45 | 6.3x7.7 | 53 | 8x10.5 | 90 | |
| 47 | 4x5.7 | 25 | 4x5.7 | 25 | 5x5.7 | 31 | 5x5.7 | 35 | 6.3x5.7 | 50 | 6.3x7.7 | 63 | 6.3x7.7 | 75 | 10x10.5 | 140 | |
| 68 | 4x5.7 | 25 | 5x5.7 | 40 | 5x5.7 | 31 | 6.3x5.7 | 48 | 6.3x5.7 | 50 | 6.3x7.7 | 63 | 8x10.5 | 125 | 10x10.5 | 155 | |
| 100 | 5x5.7 | 39 | 5x5.7 | 45 | 6.3x5.7 | 60 | 6.3x5.7 | 72 | 6.3x7.7 | 84 | 8x10.5 | 140 | 8x10.5 | 135 | | | |
| 150 | 5x5.7 | 45 | 6.3x5.7 | 62 | 6.3x5.7 | 65 | 6.3x7.7 | 95 | 6.3x7.7 | 100 | 6.3x7.7 | 95 | 8x10.5 | 155 | 10x10.5 | 205 | |
| 220 | 6.3x5.7 | 67 | 6.3x5.7 | 70 | 6.3x7.7 | 110 | 6.3x7.7 | 120 | 8x10.5 | 175 | 10x10.5 | 220 | 10x10.5 | 170 | 10x12.5 | 225 | |
| 330 | 6.3x7.7 | 105 | 6.3x7.7 | 130 | 6.3x7.7 | 120 | 8x10.5 | 195 | 8x10.5 | 220 | 10x10.5 | 240 | 10x10.5 | 245 | | | |
| 470 | 6.3x7.7 | 120 | 6.3x7.7 | 150 | 8x10.5 | 230 | 8x10.5 | 240 | 10x10.5 | 280 | 10x12.5 | 375 | | | | | |
| 680 | 8x10.5 | 210 | 8x10.5 | 240 | 10x10.5 | 270 | 10x10.5 | 255 | 10x10.5 | 350 | | | | | | | |
| 1000 | 8x10.5 | 230 | 8x10.5 | 260 | 10x10.5 | 330 | 10x12.5 | 390 | | | | | | | | | |
| 1500 | 10x10.5 | 315 | 10x12.5 | 450 | | | | | | | | | | | | | |
| 2200 | 10x10.5 | 350 | | | | | | | | | | | | | | | |

Note1: Case size ΦD x L(mm), ripple current (mA, rms) at 105°C, 120Hz.

Note2: Produce custom product too, which are not found in these tables.

■ Explanation of Part Numbers

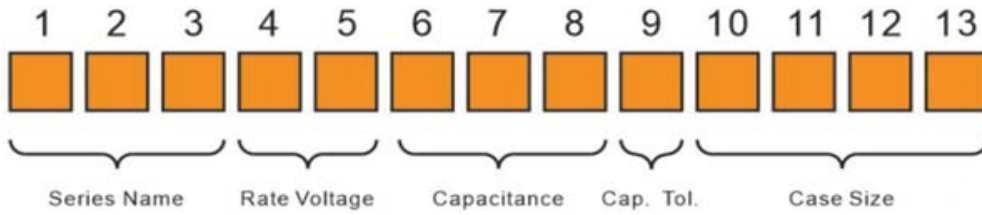

| (1-3) | (4-5) | (6-8) | (9) | (10-13) | | | | |
|--------|---------------|-------|------------------|---------|--------------------|------|-----------------|------|
| Series | Voltage (W.V) | Code | Capacitance (mF) | Code | Cap. Tolerance (%) | Code | Size ϕ DxL | Code |
| GVS | 4 | 0G | 0.1 | 0R1 | +5 | J | 4x5(5.7) | 0405 |
| GVT | 6.3 | 0J | 0.22 | 0R22 | -5 | | 4x7 | 0407 |
| GVE | 10 | 1A | 0.33 | 0R33 | +10 | K | 5x5(5.7) | 0505 |
| GVZ | 16 | 1C | 0.47 | 0R47 | -10 | | 5x7 | 0507 |
| GVM | 25 | 1E | 1 | 1R0 | +15 | L | 5x11 | 0511 |
| GVL | 35 | 1V | 2.2 | 2R2 | -15 | | 6.3x5(5.7) | 0605 |
| GVU | 50 | 1H | 3.3 | 3R3 | +20 | M | 6.3x7(7.7) | 0607 |
| GVY | 63 | 1J | 4.7 | 4R7 | -20 | | 6.3x11 | 0611 |
| GVF | 80 | 1K | 10 | 100 | +30 | N | 8x5 | 0805 |
| GVR | 100 | 2A | 22 | 220 | -30 | | 8x6.5 | 0806 |
| GVG | 125 | 2B | 33 | 330 | +20 | V | 8x9 | 0809 |
| GVD | 160 | 2C | 47 | 470 | -10 | | 8x10(10.5) | 0810 |
| GVP | 180 | 2Z | 68 | 680 | +30 | Q | 8x11(11.5) | 0811 |
| GVT | 200 | 2D | 100 | 101 | -10 | | 8x12 | 0812 |
| GVC | 220 | 2P | 220 | 221 | +50 | T | 10x10(10.5) | 1010 |
| GVN | 250 | 2E | 330 | 331 | -10 | | 10x12.5 | 1012 |
| GVK | 315 | 2F | 470 | 471 | +50 | S | 10x14 | 1014 |
| GVA | 330 | 2L | 680 | 681 | -20 | | 12.5x13.5 | 1213 |
| | 350 | 2V | 1000 | 102 | +80 | Z | 12.5x16 | 1216 |
| | 400 | 2G | 2200 | 222 | -20 | | 16x16.5 | 1616 |
| | 420 | 2Q | 3300 | 332 | +20 | R | 16x25 | 1625 |
| | 450 | 2W | 4700 | 472 | -0 | | 20x25 | 2025 |
| | 500 | 2H | 6800 | 682 | | | 35x42 | 3542 |

■ Taping Specifications

■ Carrier Tape

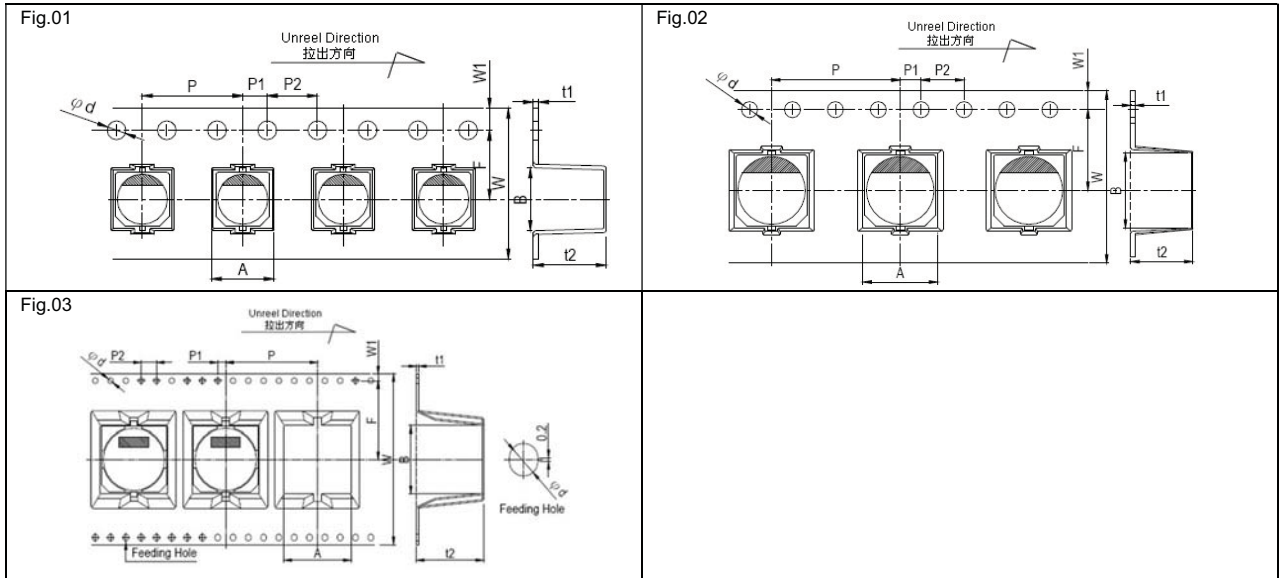

| Case Size | W (mm) | W1 (mm) | F (mm) | P (mm) | P1 (mm) | P2 (mm) | A (mm) | B (mm) | t1 (mm) | t2 (mm) |
|-------------|--------|---------|--------|--------|---------|---------|--------|--------|---------|---------|
| φ 4x5.7 | 12 | 1.75 | 5.5 | 8 | 2 | 4 | 4.7 | 4.7 | 0.4 | 6.3 |
| φ 5x5.7 | 12 | | 5.5 | 12 | | | 6 | 6 | | 6.3 |
| φ 6.3x5.7 | 16 | | 7.5 | 12 | | | 7 | 7 | | 6.3 |
| φ 6.3x7.7 | 16 | | 7.5 | 12 | | | 7 | 7 | | 8.3 |
| φ 8x6.5 | 16 | | 7.5 | 12 | | | 8.7 | 8.7 | | 7 |
| φ 8x10.5 | 24 | | 11.5 | 16 | | | 8.7 | 8.7 | | 11 |
| φ 10x10.5 | 24 | | 11.5 | 16 | | | 10.7 | 10.7 | | 11 |
| φ 10x13.5 | 24 | | 11.5 | 16 | | | 10.7 | 10.7 | | 14.1 |
| φ 12.5x13.5 | 32 | | 14.2 | 24 | | | 14 | 14 | | 14.1 |
| φ 12.5x16 | 32 | | 14.2 | 24 | | | 14 | 14 | | 16.4 |
| φ 16x16.5 | 44 | 20.2 | 28 | 17.5 | 17.5 | 16.9 | | | | |
| φ 16x21.5 | 44 | 20.2 | 28 | 17.5 | 17.5 | 21.9 | | | | |
| φ 18x16.5 | 44 | 20.2 | 32 | 19.5 | 19.5 | 16.9 | | | | |
| φ 18x21.5 | 44 | 20.2 | 32 | 19.5 | 19.5 | 21.9 | | | | |
| Tolerance | ±0.3 | ±0.15 | ±0.1 | ±0.1 | ±0.1 | ±0.1 | ±0.2 | ±0.2 | ±0.1 | ±0.2 |

■ Carrier Tape

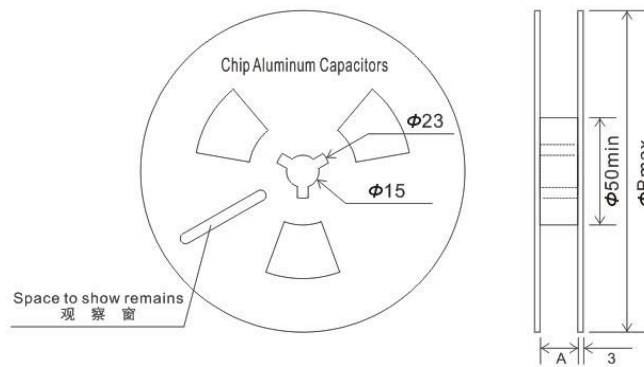

| Case Size | Reel | Carton | A±0.3 | B±2 | Case Size | Reel | Carton | A±0.3 | B±2 |
|-----------|------|--------|-------|-----|-------------|------|--------|-------|-----|
| φ 4x5.7 | 2000 | 20000 | 14 | 382 | φ 10x13.5 | 300 | 3000 | 26 | 382 |
| φ 5x5.7 | 1000 | 10000 | 14 | 382 | φ 12.5x13.5 | 200 | 600 | 34 | 332 |
| φ 6.3x5.7 | 1000 | 10000 | 18 | 382 | φ 12.5x16 | 150 | 450 | 34 | 332 |
| φ 6.3x7.7 | 1000 | 10000 | 18 | 382 | φ 16x16.5 | 125 | 250 | 46 | 332 |
| φ 8x6.5 | 1000 | 10000 | 18 | 382 | φ 16x21.5 | 75 | 150 | 46 | 332 |
| φ 8x10.2 | 500 | 5000 | 26 | 382 | φ 18x16.5 | 125 | 250 | 46 | 332 |
| φ 10x10.2 | 500 | 5000 | 26 | 382 | φ 18x21.5 | 75 | 150 | 46 | 332 |

Reflow Soldering Conditions

Recommended soldering heat conditions

- The following conditions are recommended for air convection and infrared reflow soldering on the SMD products onto a glass epoxy circuit boards by cream solder. The temperatures shown are the surface temperature values on the top of the can and on the capacitor terminals.
- Reflow should be performed twice or less.
- Please ensure that the capacitor became cold enough to the room temperature (5 to 35°C) before the second reflow.

Classification Reflow Profile

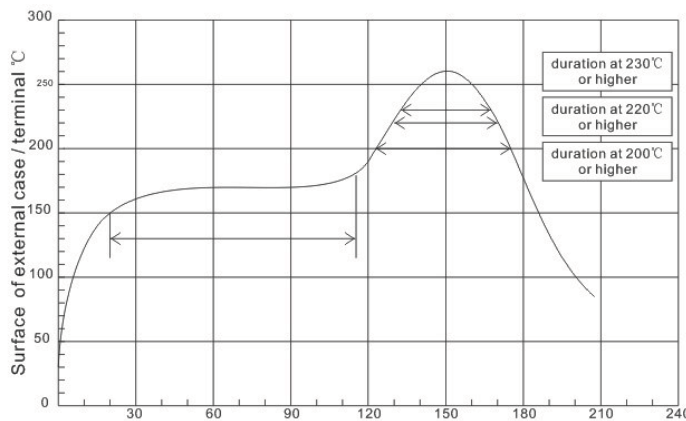

Notice:

- Average ramp-up rate is 5°C/second max.
- Ramp-down rate is 6°C/second max.
- Time from 25°C to peak temperature is 6 minutes max.

| | Preheat | Time maintained above 200°C | Time maintained above 220°C | Time maintained above 230°C | Peak temp. | Reflow number |
|----------------------|------------------------------------|-----------------------------|-----------------------------|-----------------------------|------------|-----------------|
| Dia. 4~10mm general | 120°C to 180°C 120 sec. Max. | 60 sec. | 50 sec. | 30 sec. | 250°C Max. | 2 times or less |
| φ8x6.5 | | 50 sec. | 40 sec. | 25 sec. | 245°C Max. | 2 times or less |
| WV 160v-450v | | 60 sec. | 50 sec. | 30 sec. | 240°C Max. | 2 times or less |
| Dia. 12.5~20mm Cap. | | 60 sec. | 40 sec. | 30 sec. | 240°C Max. | 2 times or less |
| 125°C Category Temp. | | 60 sec. | 40 sec. | 30 sec. | 250°C Max. | 2 times or less |

Recommended Solder Land Size on PC Board

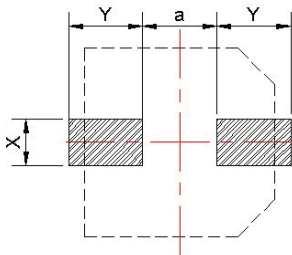

| Size | X | Y | a |
|---------|-----|-----|-----|
| φ4 | 1.6 | 2.6 | 1.0 |
| φ5 | 1.6 | 3.0 | 1.4 |
| φ6.3 | 1.6 | 3.5 | 2.1 |
| φ8x6.5 | 1.6 | 4.5 | 2.1 |
| φ8x10.5 | 2.5 | 3.5 | 3.0 |
| φ10 | 2.5 | 4.0 | 4.0 |
| φ12.5 | 3.0 | 5.7 | 4.0 |
| φ16 | 3.5 | 6.5 | 6.0 |

X-ON Electronics

Largest Supplier of Electrical and Electronic Components

Click to view similar products for [Aluminium Electrolytic Capacitors - SMD category](#):

Click to view products by [Honor manufacturer](#):

Other Similar products are found below :

[ULV2H4R7MNL1GS](#) [ULV2H1R8MNL1GS](#) [MAL214099813E3](#) [CA025M4R70REB-0405](#) [HUB1800-S](#) [UCX1V471MNQ1MS](#) [10SVP120M](#)
[DV100M050C055ETR](#) [RVJ-50V101MH10U-R](#) [AEH1012471M016R](#) [MAL213967339E3](#) [GVT1C337M0608CNVC](#) [ATB106M050D058](#)
[ATB476M050F065](#) [ATB476M035E058](#) [ATB107M016E058](#) [ATB107M035E077](#) [EMVE350ARA101MF80G](#) [EMHL250ARA221MHA0G](#)
[ATB477M016F102](#) [EMK1EM331FB0D00R](#) [EMF1CM221FB0D00R](#) [EMF1CM331FB0D00R](#) [EMF1CM471FB0D00R](#)
[EMK1JM101GB0D00R](#) [EMK1AM102GB0D00R](#) [EMK1HM221GB0D00R](#) [DV221M6R3E055ETR](#) [DV221M025E077ETR](#)
[RV331M025F105ETR](#) [RVT1A101M0505](#) [GVZ1H101M0607](#) [CK1E100M0405](#) [GVM1E331M0607](#) [VT10UF100V167RV0127](#)
[VT100UF16V167RV0124](#) [CS100UF35V167RV0155](#) [CK220UF16V167RV0142](#) [VT10UF16V167RV0128](#) [VT22UF35V167RV0131](#)
[CS470UF10V167RV0150](#) [CK100UF16V167RV0138](#) [CK220UF10V167RV0141](#) [RVT330UF25V167RV0055](#) [CS47UF16V167RV0152](#)
[VT470UF16V167RV0135](#) [CS100UF10V167RV0144](#) [126RV0017](#) [VT47UF35V167RV0137](#) [CS220UF35V167RV0148](#)