

Surface Mount Aluminum Electrolytic Capacitors

GVT 105°C,2000Hrs,Standard Series

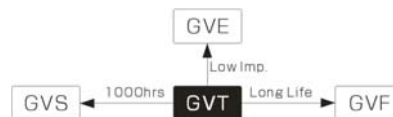

Features

105°C, 2000 hours assured.
Available for high density surface mounting.
High stability and reliability.

Specifications

Item	Condition	Specifications										
Category Temperature Range(°C)	—	-55°C ~ +105°C										
Capacitance Tolerance (%)	120Hz, 20°C	±20%										
Rated Voltage (V)	—	6.3	10	16	25	35	50	63	100			
Dissipation Factor (tanδ)	120Hz, 20°C (Max.)	tanδ	0.30	0.24	0.20	0.18	0.16	0.14	0.14	0.14		
		Notes	Exceeding 1,000uF, +0.02 every 1,000uF									
Leakage Current (LC)	After 2 minutes, 20°C (uA, Max.)	0.01CV or 3uA, whichever is greater.										
Low Temperature Characteristics	Impedance Ratio (Max.)	Z _{-25°C} /Z _{+20°C}	5	4	3	2	2	2	2	2		
		Z _{-40°C} /Z _{+20°C}	10	8	6	4	3	3	3	3		
Endurance	105°C, Rated Voltage Applied (With the rated ripple current)	Hours	2,000									
		ΔC/C	Within ±30% of initial value									
		tanδ	300% or less of the initial specified value									
		LC	The initial specified value or less									
Shelf life	105°C	Hours	1,000									
		Other Items	same as those for the endurance.									

Dimensions

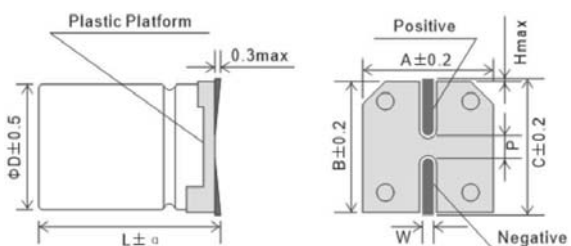

D	L	A	B	C	P	α	W
4	5.7	4.3	4.3	5.0	1.0	±0.3	0.5-0.8
5	5.7	5.3	5.3	6.0	1.5	±0.3	0.5-0.8
6.3	5.7	6.6	6.6	7.3	2.0	±0.3	0.5-0.8
6.3	7.7	6.6	6.6	7.3	2.0	±0.3	0.5-0.8
8	10.5	8.3	8.3	9.0	3.1	±0.5	0.7-1.2
10	10.5	10.3	10.3	11.0	4.7	±0.5	0.7-1.2

Rated Ripple Current Multipliers

Frequency (Hz)	50	120	1k	10k up
Capacitance (uF)				
Under 100	0.70	1.00	1.35	1.50
100 ~ 2200uF	0.80	1.00	1.20	1.30

GVT

 Series

■ Dimensions

uF	WV	6.3v (0J)		10v (1A)		16v (1C)		25v (1E)		35v (1V)		50v (1H)		63v (1J)		100v (2A)	
		ΦD x L	R.C.	ΦD x L	R.C.	ΦD x L	R.C.	ΦD x L	R.C.	ΦD x L	R.C.	ΦD x L	R.C.	ΦD x L	R.C.	ΦD x L	R.C.
1.0												4x5.7	7	4x5.7	7	4x5.7	7
2.2												4x5.7	11	4x5.7	11	4x5.7	9
3.3										4x5.7	13	4x5.7	13	5x5.7	13	5x5.8	14
4.7								4x5.7	13	4x5.7	14	4x5.7	13	5x5.7	16	5x5.8	16
6.8								4x5.7	14	4x5.7	14	4x5.7	14	5x5.7	17	6.3x5.7	21
10						4x5.7	18	4x5.7	14	4x5.7	14	5x5.7	18	5x5.7	19	6.3x5.7	35
22				4x5.7	20	4x5.7	20	4x5.7	19	5x5.7	30	6.3x5.7	42	6.3x5.7	40	6.3x7.7	60
33	4x5.7	22	4x5.7	22	4x5.7	22	4x5.7	22	5x5.7	34	6.3x5.7	45	6.3x7.7	53	8x10.5	90	
47	4x5.7	25	4x5.7	25	5x5.7	31	5x5.7	35	6.3x5.7	50	6.3x7.7	63	6.3x7.7	75	10x10.5	140	
68	4x5.7	25	5x5.7	40	5x5.7	31	6.3x5.7	48	6.3x5.7	50	6.3x7.7	63	8x10.5	125	10x10.5	155	
100	5x5.7	39	5x5.7	45	6.3x5.7	60	6.3x5.7	72	6.3x7.7	84	8x10.5	140	8x10.5	135			
150	5x5.7	45	6.3x5.7	62	6.3x5.7	65	6.3x7.7	95	6.3x7.7	100	6.3x7.7	95	8x10.5	155	10x10.5	205	
220	6.3x5.7	67	6.3x5.7	70	6.3x7.7	110	6.3x7.7	120	8x10.5	175	10x10.5	220	10x10.5	170	10x12.5	225	
330	6.3x7.7	105	6.3x7.7	130	6.3x7.7	120	8x10.5	195	8x10.5	220	10x10.5	240	10x10.5	245			
470	6.3x7.7	120	6.3x7.7	150	8x10.5	210	8x10.5	230	8x10.5	240	10x10.5	280	10x12.5	375			
680	8x10.5	210	8x10.5	240	10x10.5	270	10x10.5	315	10x10.5	350	10x12.5	400					
1000	8x10.5	230	10x10.5	300	8x10.5	260	10x10.5	330	10x12.5	390							
1500	10x10.5	315	10x12.5	450													
2200	10x10.5	350															

Note1: Case size ΦD x L(mm), ripple current (mA, rms) at 105°C, 120Hz.

Note2: Produce custom product too, which are not found in these tables.

■ Explanation of Part Numbers

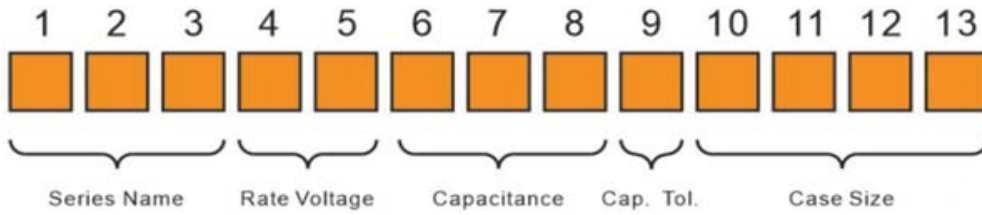

(1-3)	(4-5)	(6-8)	(9)	(10-13)				
Series	Voltage (W.V)	Code	Capacitance (mF)	Code	Cap. Tolerance (%)	Code	Size ϕ DxL	Code
GVS	4	0G	0.1	0R1	+5	J	4x5(5.7)	0405
GVT	6.3	0J	0.22	0R22	-5		4x7	0407
GVE	10	1A	0.33	0R33	+10	K	5x5(5.7)	0505
GVZ	16	1C	0.47	0R47	-10		5x7	0507
GVM	25	1E	1	1R0	+15	L	5x11	0511
GVL	35	1V	2.2	2R2	-15		6.3x5(5.7)	0605
GVU	50	1H	3.3	3R3	+20	M	6.3x7(7.7)	0607
GVY	63	1J	4.7	4R7	-20		6.3x11	0611
GVF	80	1K	10	100	+30	N	8x5	0805
GVR	100	2A	22	220	-30		8x6.5	0806
GVG	125	2B	33	330	+20	V	8x9	0809
GVD	160	2C	47	470	-10		8x10(10.5)	0810
GVP	180	2Z	68	680	+30	Q	8x11(11.5)	0811
GVT	200	2D	100	101	-10		8x12	0812
GVC	220	2P	220	221	+50	T	10x10(10.5)	1010
GVN	250	2E	330	331	-10		10x12.5	1012
GVK	315	2F	470	471	+50	S	10x14	1014
GVA	330	2L	680	681	-20		12.5x13.5	1213
	350	2V	1000	102	+80	Z	12.5x16	1216
	400	2G	2200	222	-20		16x16.5	1616
	420	2Q	3300	332	+20	R	16x25	1625
	450	2W	4700	472	-0		20x25	2025
	500	2H	6800	682			35x42	3542

■ Taping Specifications

■ Carrier Tape

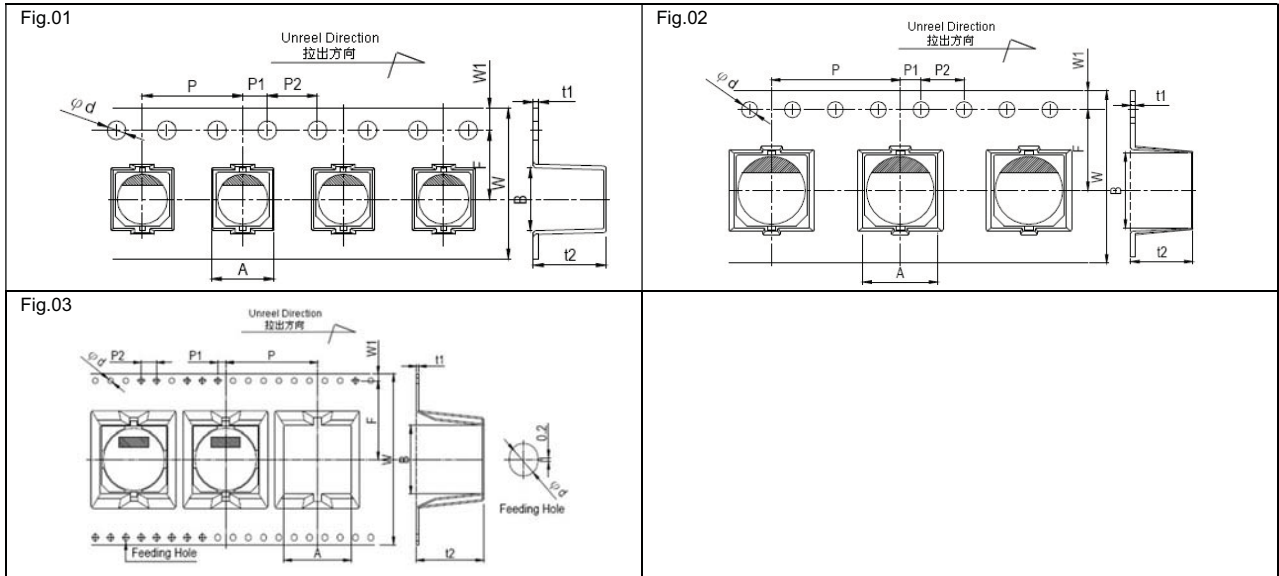

Case Size	W (mm)	W1 (mm)	F (mm)	P (mm)	P1 (mm)	P2 (mm)	A (mm)	B (mm)	t1 (mm)	t2 (mm)
φ 4x5.7	12	1.75	5.5	8	2	4	4.7	4.7	0.4	6.3
φ 5x5.7	12		5.5	12			6	6		6.3
φ 6.3x5.7	16		7.5	12			7	7		6.3
φ 6.3x7.7	16		7.5	12			7	7		8.3
φ 8x6.5	16		7.5	12			8.7	8.7		7
φ 8x10.5	24		11.5	16			8.7	8.7		11
φ 10x10.5	24		11.5	16			10.7	10.7		11
φ 10x13.5	24		11.5	16			10.7	10.7		14.1
φ 12.5x13.5	32		14.2	24			14	14		14.1
φ 12.5x16	32		14.2	24			14	14		16.4
φ 16x16.5	44	20.2	28	17.5	17.5	16.9				
φ 16x21.5	44	20.2	28	17.5	17.5	21.9				
φ 18x16.5	44	20.2	32	19.5	19.5	16.9				
φ 18x21.5	44	20.2	32	19.5	19.5	21.9				
Tolerance	±0.3	±0.15	±0.1	±0.1	±0.1	±0.1	±0.2	±0.2	±0.1	±0.2

■ Carrier Tape

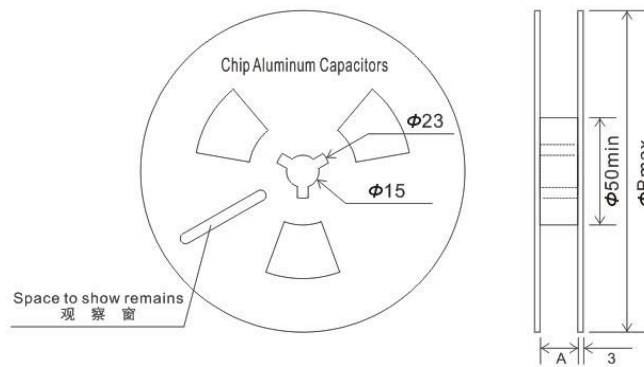

Case Size	Reel	Carton	A±0.3	B±2	Case Size	Reel	Carton	A±0.3	B±2
φ 4x5.7	2000	20000	14	382	φ 10x13.5	300	3000	26	382
φ 5x5.7	1000	10000	14	382	φ 12.5x13.5	200	600	34	332
φ 6.3x5.7	1000	10000	18	382	φ 12.5x16	150	450	34	332
φ 6.3x7.7	1000	10000	18	382	φ 16x16.5	125	250	46	332
φ 8x6.5	1000	10000	18	382	φ 16x21.5	75	150	46	332
φ 8x10.2	500	5000	26	382	φ 18x16.5	125	250	46	332
φ 10x10.2	500	5000	26	382	φ 18x21.5	75	150	46	332

Reflow Soldering Conditions

Recommended soldering heat conditions

- The following conditions are recommended for air convection and infrared reflow soldering on the SMD products onto a glass epoxy circuit boards by cream solder. The temperatures shown are the surface temperature values on the top of the can and on the capacitor terminals.
- Reflow should be performed twice or less.
- Please ensure that the capacitor became cold enough to the room temperature (5 to 35°C) before the second reflow.

Classification Reflow Profile

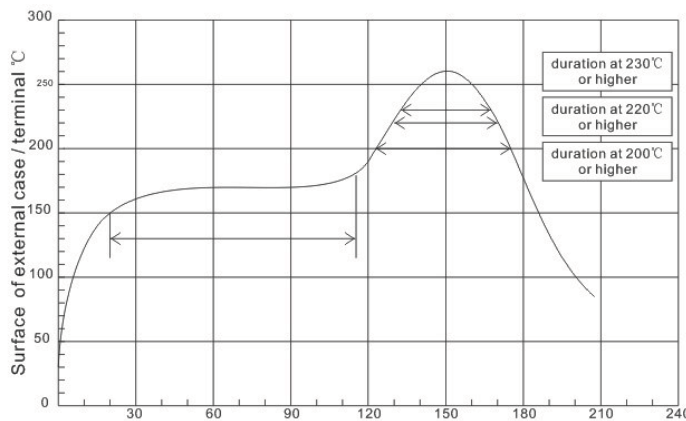

Notice:

- Average ramp-up rate is 5°C/second max.
- Ramp-down rate is 6°C/second max.
- Time from 25°C to peak temperature is 6 minutes max.

	Preheat	Time maintained above 200°C	Time maintained above 220°C	Time maintained above 230°C	Peak temp.	Reflow number
Dia. 4~10mm general	120°C to 180°C 120 sec. Max.	60 sec.	50 sec.	30 sec.	250°C Max.	2 times or less
φ8x6.5		50 sec.	40 sec.	25 sec.	245°C Max.	2 times or less
WV 160v-450v		60 sec.	50 sec.	30 sec.	240°C Max.	2 times or less
Dia. 12.5~20mm Cap.		60 sec.	40 sec.	30 sec.	240°C Max.	2 times or less
125°C Category Temp.		60 sec.	40 sec.	30 sec.	250°C Max.	2 times or less

Recommended Solder Land Size on PC Board

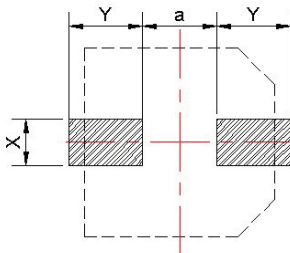

Size	X	Y	a
φ4	1.6	2.6	1.0
φ5	1.6	3.0	1.4
φ6.3	1.6	3.5	2.1
φ8x6.5	1.6	4.5	2.1
φ8x10.5	2.5	3.5	3.0
φ10	2.5	4.0	4.0
φ12.5	3.0	5.7	4.0
φ16	3.5	6.5	6.0

X-ON Electronics

Largest Supplier of Electrical and Electronic Components

Click to view similar products for [Aluminium Electrolytic Capacitors - SMD category](#):

Click to view products by [Honor manufacturer](#):

Other Similar products are found below :

[ULV2H4R7MNL1GS](#) [ULV2H1R8MNL1GS](#) [MAL214099813E3](#) [CA025M4R70REB-0405](#) [HUB1800-S](#) [UCX1V471MNQ1MS](#) [10SVP120M](#)
[DV100M050C055ETR](#) [RVJ-50V101MH10U-R](#) [AEH1012471M016R](#) [MAL213967339E3](#) [GVT1C337M0608CNVC](#) [ATB106M050D058](#)
[ATB476M050F065](#) [ATB476M035E058](#) [ATB107M016E058](#) [ATB107M035E077](#) [EMVE350ARA101MF80G](#) [EMHL250ARA221MHA0G](#)
[ATB477M016F102](#) [EMK1EM331FB0D00R](#) [EMF1CM221FB0D00R](#) [EMF1CM331FB0D00R](#) [EMF1CM471FB0D00R](#)
[EMK1JM101GB0D00R](#) [EMK1AM102GB0D00R](#) [EMK1HM221GB0D00R](#) [DV221M6R3E055ETR](#) [DV221M025E077ETR](#)
[RV331M025F105ETR](#) [RVT1A101M0505](#) [GVZ1H101M0607](#) [CK1E100M0405](#) [GVM1E331M0607](#) [VT10UF100V167RV0127](#)
[VT100UF16V167RV0124](#) [CS100UF35V167RV0155](#) [CK220UF16V167RV0142](#) [VT10UF16V167RV0128](#) [VT22UF35V167RV0131](#)
[CS470UF10V167RV0150](#) [CK100UF16V167RV0138](#) [CK220UF10V167RV0141](#) [RVT330UF25V167RV0055](#) [CS47UF16V167RV0152](#)
[VT470UF16V167RV0135](#) [CS100UF10V167RV0144](#) [126RV0017](#) [VT47UF35V167RV0137](#) [CS220UF35V167RV0148](#)