

RVT-VT

宽温品 片式铝电解电容
Chip Type Aluminum Electrolytic Capacitors



表面安装



小型薄形品



宽温度品



耐清洗品



产品特点 Features

适用-55℃~+105℃温度范围, 寿命2,000小时; 性能稳定, 可靠性高; 产品直径: φ 4mm~ φ 16.5mm
-55℃~+105℃ temperature range, life 2000 hours; stable performance, high reliability
The diameter of the product: φ 4mm~ φ 12.5mm

主要技术性能 Specifications

项目 Items	特性 Characteristics									
工作温度范围 Category Temperature Range	-55℃~+105℃									
额定电压范围 Rated Voltage Range	4~100V.DC									
标称容量范围 Nominal Capacitance Range	1μF ~ 2200 μF									
标称容量允许偏差 Nominal Capacitance Tolerance	± 20%(120Hz,+20 °C)									
泄漏电流范围 Leakage Current(MAX)	I=0.01CV(μ A) or 3 (μ A) after 2 minutes I=Leakage Current(μ A) C=Nominal Capacitance(μ F) V=Roted Voltage(V)									
损耗角正切值 Dissipation Factor(MAX) Tan δ (20℃,120Hz)	Rated Voltage(V)	4	6.3	10	16	25	35	50	63	100
	Tan δ	0.35	0.30	0.24	0.20	0.18	0.16	0.14	0.14	0.14
耐久性 Load Life	+105℃施加额定工作电压2000H后, 放置16H, 电容器应满足以下要求。 After applying rated voltage with max ripple current for 2000hrs at 105℃,and then resumed 16 hours, the capacitors shall meet the following requirements									
	Capacitance Change	± 30%初始值以内		Within ± 30% of the initial value						
	Dissipation Factor	≤ 200%初始值以内		Not more than 200% of the specified value						
	Leakage Current	≤ 初始规定值		Not more than the specified value						
高温贮存 Shelf Life	+105℃, 贮存1000H后, 放置16H, 电容器应满足以下要求。 After storage for 1000hrs at 105℃, then resumed 16 hours, the capacitors shall meet the following requirements									
	Capacitance Change	± 30%初始值以内		Within ± 30% of the initial value						
	Dissipation Factor	≤ 200%初始值以内		Not more than 200% of the specified value						
	Leakage Current	≤ 300%初始值以内		Within 300% of initial specified value						
耐焊接热 Resistance to Soldering Heat	在250℃的条件下, 电容器在热板上保持30秒, 然后从热板上取出电容器, 让其在室温下恢复, 电容器应满足以下要求。 The capacitors shall be kept on then hot plate maintained at 250℃ for 30 seconds.After removing from the hot plate and restored at room temperature, they meet the following requirement:									
	Capacitance Change	± 10%初始值以内		Within ± 10% of the initial value						
	Dissipation Factor	≤ 初始规定值		Not more than the initial specified value						
	Leakage Current	≤ 初始规定值		Not more than the initial specified value						
低温特性及阻抗比 Low Temperature Stability Impedance Ratio (MAX) 120Hz	Roted Voltage (V)	4	6.3	10	16	25	35	50	63	100
	Z-25℃/Z+20℃ (120Hz)	< Φ8	7	4	3	2	2	2	2	2
		≥ Φ8	7	5	4	3	2	2	2	2
	Z-40℃/Z+20℃ (120Hz)	< Φ8	15	8	8	4	4	3	3	3
		≥ Φ8	15	10	8	6	4	3	3	3

■ 尺寸图 Dimensions

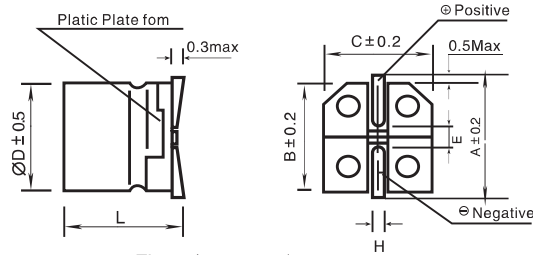

Fig. 1 (Φ4~Φ10)

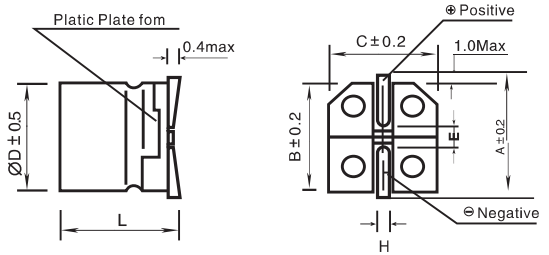

Fig. 2 (≥Φ16.5)

单位: mm

ΦD	L	A	B	C	E	H	Fig.No.
4	5.4±0.3	5.0	4.3	4.3	1.0	0.5~0.9	1
5	5.4±0.3	6.0	5.3	5.3	1.5	0.5~0.9	1
6.3	5.4±0.3	7.2	6.6	6.6	2.1	0.5~0.9	1
6.3	7.7±0.3	7.2	6.6	6.6	2.1	0.5~0.9	1
8	6.5±0.5	9.1	8.3	8.3	3.1	0.8~1.1	1
8	10.2±0.5	9.1	8.3	8.3	3.1	0.8~1.1	1
10	10.2±0.5	11.1	10.3	10.3	4.5	0.8~1.1	1
12.5	13.5±0.5	13.7	13.0	13.0	4.4	1.0~1.4	2
16	16.5±0.5	16.7	17	17	6.7	1.0~1.4	2

■ 标准品一览表 Standard Size

V	6.3		10		16		25		35		50		63		100	
μF	D×Lmm	mA	D×Lmm	mA	D×Lmm	mA	D×Lmm	mA	D×Lmm	mA	D×Lmm	mA	D×Lmm	mA	D×Lmm	mA
0.1											4×5.4	0.7				
0.22											4×5.4	1.6				
0.33											4×5.4	2.5				
0.47											4×5.4	3.5				
0.68											4×5.4	5				
1											4×5.4	8.0	4×5.4	7.2	4×5.4	7.2
2.2											4×5.4	12	4×5.4	12	6.3×5.4	15
3.3									4×5.4	14	4×5.4	14	5×5.4	14	6.3×5.4	
4.7							4×5.4	14	4×5.4	15	4×5.4	14	5×5.4	17	6.3×5.4	23
							5×5.4	21	5×5.4	22	6.3×5.4	25	6.3×7.7	22	6.3×7.7	38
10				4×5.4			4×5.4	15	4×5.4	15	5×5.4	23	6.3×5.4	41	6.3×7.7	38
							5×5.4	21	5×5.4	22	6.3×5.4	25	6.3×7.7	26	6.3×7.7	38
22	4×5.4	22	4×5.4	21	4×5.4	21	5×5.4	26	5×5.4	30	6.3×5.4	43	6.3×7.7	53	8×10.2	90
			5×5.4	26	5×5.4	28	6.3×5.4	37	6.3×5.4	40	6.3×5.4	43	8×6.5	80	8×10.2	90
33	4×5.4	23	4×5.4	23	5×5.4	29	5×5.4	30	6.3×5.4	45	6.3×7.7	63	8×10.2	116	10×10.2	136
	5×5.4	28	5×5.4	34	5×5.4	29	6.3×5.4	45	8×6.5	86	6.3×7.7	63	8×10.2	116	10×10.2	136
47	4×5.4	26	4×5.4	27	5×5.4	33	5×5.4	30	6.3×5.4	45	6.3×7.7	66	8×10.2	125	10×10.2	148
	5×5.4	34	5×5.4	31	6.3×5.4	48	8×6.5	93	6.3×7.7	75	8×10.2	120	10×10.2	168	10×10.2	148

mA额定纹波电流 Rated ripple current(mA, 105°C, 120Hz)

■ 纹波电流修正系数/频率系数 Multiplier For Ripple Current / Frequency coefficient

频率 Frequency	50Hz	120Hz	300Hz	1kHz	≥10kHz
系数 Coefficient	0.70	1.00	1.17	1.36	1.50

注: 以上所提供的的设计及特性参数仅供参考, 任何修改不做预先通知, 如在使用上有疑问, 请在采购前与我们联系, 以便提供技术上的协助。
 Note: all designs and specifications are for reference only and are subject to change without prior notice, if any doubt about safety for your application, please contact us immediately for technical assistance before purchase.

■ 尺寸图 Dimensions

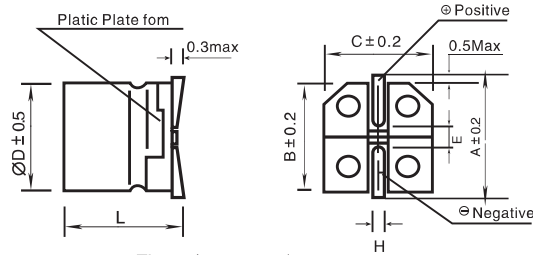

Fig. 1 (Φ4~Φ10)

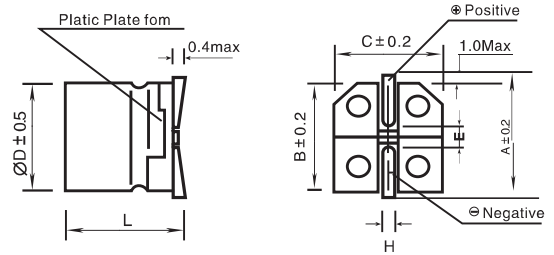

Fig. 2 (≥Φ16.5)

单位: mm

ΦD	L	A	B	C	E	H	Fig.No.
4	5.4±0.3	5.0	4.3	4.3	1.0	0.5~0.9	1
5	5.4±0.3	6.0	5.3	5.3	1.5	0.5~0.9	1
6.3	5.4±0.3	7.2	6.6	6.6	2.1	0.5~0.9	1
6.3	7.7±0.3	7.2	6.6	6.6	2.1	0.5~0.9	1
8	6.5±0.5	9.1	8.3	8.3	3.1	0.8~1.1	1
8	10.2±0.5	9.1	8.3	8.3	3.1	0.8~1.1	1
10	10.2±0.5	11.1	10.3	10.3	4.5	0.8~1.1	1
12.5	13.5±0.5	13.7	13.0	13.0	4.4	1.0~1.4	2
16	16.5±0.5	16.7	17	17	6.7	1.0~1.4	2

■ 标准品一览表 Standard Size

V	6.3		10		16		25		35		50		63		100	
μF	D×Lmm	mA	D×Lmm	mA	D×Lmm	mA	D×Lmm	mA	D×Lmm	mA	D×Lmm	mA	D×Lmm	mA	D×Lmm	mA
100	5×5.4	40	5×5.4	40	6.3×5.4	63	6.3×5.4	49	6.3×5.4	45	8×10.2	146	10×10.2	200	25×13.5	276
	6.3×5.4	52	6.3×5.4	55	6.3×7.7	72	6.3×7.7	93	6.3×7.7	87		8×10.2		178		10×10.2
150	6.3×5.4	70	6.3×5.4	78	6.3×7.7	116	8×10.2	210	8×10.2	210	8×10.2	238	12.5×13.5	330		
	6.3×5.4	69	6.3×5.4	78	6.3×7.7	110	6.3×7.7	93	8×10.2	195	10×10.2	230	12.5×13.5	380		
220	6.3×7.7	108	6.3×7.7	110	8×6.5	110	8×10.2	183	10×10.2	230		10×10.2	230	12.5×13.5	360	16×21.5
	6.3×7.7	108	8×6.5	110							8×10.2		201			
330	6.3×7.7	108	6.3×7.7	134	8×10.2	201	8×10.2	228	10×10.2	247	10×10.2	230	12.5×13.5	360	16×21.5	9000
	6.3×7.7	108	8×10.2	108							8×10.2	201				
470	6.3×7.7	125	6.3×7.7	160	8×10.2	240	8×10.2	228	10×10.2	286	12.5×13.5	360	16×16.5	750		
	8×10.2	214	8×10.2	214	10×10.2	300	10×10.2	286							10×10.2	286
680	8×10.2	214	10×10.2	277	10×10.2	322	10×13.5	400	10×13.5	400						
	8×10.2	214	10×10.2	277	10×10.2	322	12.5×13.5	440	12.5×13.5	440						
1000	8×10.2	235	8×10.2	230	10×10.2	347	12.5×13.5	500	16×16.5	750						
	10×10.2	310	10×10.2	320							10×10.2	347	12.5×13.5	500	16×16.5	750
1500	10×10.2	320	10×12.5	480	12.5×13.5	540										
	10×10.2	320	12.5×13.5	540			12.5×13.5	540								
2200	12.5×13.5	600	12.5×13.5	600												

mA额定纹波电流 Rated ripple current(mA, 105°C, 120Hz)

■ 纹波电流修正系数/频率系数 Multiplier For Ripple Current / Frequency coefficient

频率 Frequency	50Hz	120Hz	300Hz	1kHz	≥10kHz
系数 Coefficient	0.70	1.00	1.17	1.36	1.50

注: 以上所提供的设计及特性参数仅供参考, 任何修改不做预先通知, 如在使用上有疑问, 请在采购前与我们联系, 以便提供技术上的协助。
 Note: all designs and specifications are for reference only and are subject to change without prior notice, if any doubt about safety for your application, please contact us immediately for technical assistance before purchase.

产品编码解析 Explanation of Part Number

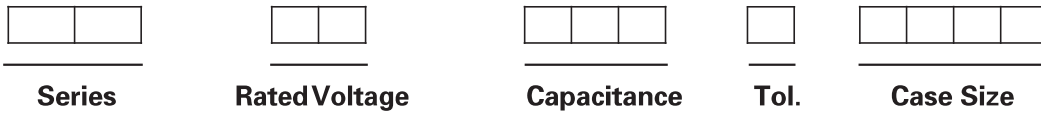

Series	R.W Voltage (V)	Code	Capacitance (μF)	Code	Cap.Tol	Code	Case Size	Code
VT	4	0G	0.1	0R1	± 5	J	4*5.4	0405
RVT	6.3	0J	0.22	R22	± 10	K	5*5.4	0505
RVE	10	1A	0.33	R33	± 15	L	6.3*5.4	0605
US	16	1C	0.47	R47	± 20	M	6.3*7.7	0607
UZ	25	1E	1	1R0	± 30	N	6.3*10.2	0610
UN	35	1V	1.5	1R5	+ 20 - 10	V	8*6.5	0806
UH	50	1H	2.2	2R2	+ 20 - 5	H	8*10.2	0810
UL	63	1J	3.3	3R3	+ 10 - 20	C	8*12.5	0812
UV	80	1K	4.7	4R7	+ 100 - 0	P	10*10.2	1010
UD	100	2A	5.6	5R6	+ 30 - 10	Q	10*12.5	1012
UW	160	2C	6.8	6R8	+ 20 - 0	R	10*13.5	1013
SF	200	2D	8.2	8R2	+ 50 - 10	T	12.5*13.5	1213
SH	250	2E	10	100	+ 75 - 10	U	12.5*16	1216
SL	350	2V	12	120	+ 40 - 20	X	16*16.5	1616
SR	400	2G	15	150	+ 50 - 20	S	16*21.5	1621
SS	450	2W	22	220	+ 80 - 20	Z	18*16.5	1816
ST	450	2W	22	220	+ 80 - 20	Z	18*16.5	1816
SU	500	2H	33	330			18*21.5	1821
HS			47	470			20*16.5	2016
			56	560			20*21.5	2021
			68	680				
			100	101				
			220	221				
			330	331				
			470	471				
			560	561				
			680	681				
			820	821				
			1000	102				
			1500	152				
			2200	222				
			3300	332				
			4700	472				
			6800	682				

卷筒 Taping Reel And Packing Quantity

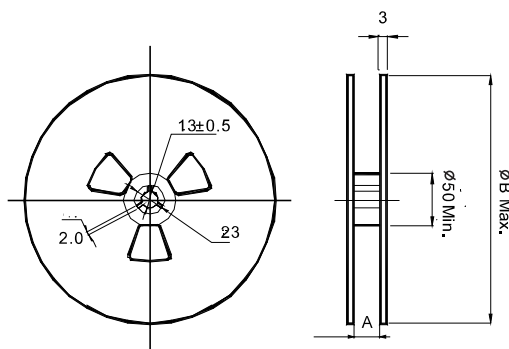

规格 Specification	卷装数量 Quantity/Reel	盒装数量 Quantity/Bag	A ± 0.3 (MM)	B ± 2 (MM)
Φ4*5.4	2000 pcs	20000 pcs	14	382
Φ5*5.4	1000 pcs	10000 pcs	14	382
Φ6.3*5.4	1000 pcs	10000 pcs	18	382
Φ6.3*7.7	1000 pcs	10000 pcs	18	382
Φ6.3*10.2	700 pcs	7000 pcs	18	382
Φ8*6.5	1000 pcs	10000 pcs	18	382
Φ8*10.2	500 pcs	5000 pcs	26	382
Φ8*12.5	400 pcs	4000 pcs	26	382
Φ10*10.2	500 pcs	5000 pcs	26	382
Φ10*12.5	400 pcs	4000 pcs	26	382
Φ10*13.5	300 pcs	3000 pcs	26	382
Φ12.5*13.5	200 pcs	1600 pcs	34	382
Φ12.5*16	200 pcs	1600 pcs	34	382
Φ16*16.5	125 pcs	250 pcs	46	332
Φ16*21.5	75 pcs	150 pcs	46	332
Φ18*16.5	125 pcs	250 pcs	46	332
Φ18*21.5	75 pcs	150 pcs	46	332
Φ20*16.5	100 pcs	200 pcs	46	332
Φ20*21.5	50 pcs	100 pcs	46	332

焊接方法和再流焊允许范围 Soldering method and allowable range of the reflow

焊接方式 Soldering Method	再流焊的允许范围 Allowable Range of Reflow
热板再流焊 Hot-Plate Reflow	<p>热板再流焊 Hot-plate Reflow</p> <p>再流焊时间(秒) Reflow time(second)</p>
红外线再流焊 Infrared-Ray Reflow	<p>红外线再流焊 Infrared-Ray Reflow</p> <p>再流焊时间(秒) Reflow time(second)</p>

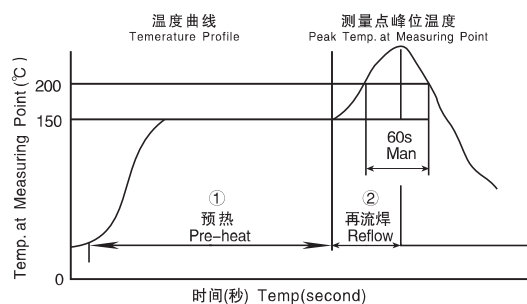

X-ON Electronics

Largest Supplier of Electrical and Electronic Components

Click to view similar products for [Aluminium Electrolytic Capacitors - SMD category](#):

Click to view products by [Honor manufacturer](#):

Other Similar products are found below :

[EEV-FK1E332W](#) [ULV2H1R8MNL1GS](#) [MAL214099813E3](#) [CA025M4R70REB-0405](#) [HUB1800-S](#) [34610](#) [RYK-50V101MG5TT-FL](#)
[107AXZ016MQ5](#) [RVJ-50V101MH10U-R](#) [EMVH101GRA221MMN0S](#) [MAL214097402E3](#) [MAL215375471E3](#) [MAL224699909E3](#)
[MAL224699813E3](#) [MAL215099017E3](#) [MAL215099818E3](#) [AEH1010331M025R](#) [AEA1010102M016R](#) [AEH1012471M016R](#)
[MAL213967339E3](#) [ZSC00AF2211EARL](#) [VB1E100MB054000CE0](#) [RVT1000UF10V34RV0081](#) [XT100UF50V90RV0067](#)
[RVE100UF16V67RV0046](#) [XT47UF50V90RV0082](#) [XT22UF50V90RV0083](#) [RST22UF50V026](#) [RST100UF25V004](#) [RST47UF25V035](#)
[XT10UF25V90RV0068](#) [FZ100UF50V90RV0066](#) [RST100UF16V003](#) [XT100UF10V90RV0060](#) [XT100UF16V90RV0061](#)
[XT100UF35V90RV0065](#) [FZ100UF35V90RV0064](#) [XT100UF25V90RV0062](#) [XT220UF10V90RV0073](#) [XT220UF35V90RV0076](#)
[XT47UF35V90RV0081](#) [RST10UF50V016](#) [RST220UF10V018](#) [XT100UF16V90RV0074](#) [RST47UF25V036](#) [RVT10UF50V34RV0011](#)
[FZ100UF25V90RV0063](#) [LZ220UF35V90RV0077](#) [XT10UF50V90RV0071](#) [XT470UF35V90RV0080](#)