

3D VIEW

1. CONTACT CURRENT RATING: 1A.
2. CONTACT RESISTANCE: 50 mΩ MAX.;
3. INSULATION RESISTANCE: 100MΩ MIN.;
4. DIELECTRIC WITHSTANDING: 500V AC MIN.;
5. DURABILITY: 5,000 CYCLES MIN.;
6. CONNECTOR MATING FORCES: 30N MAX.;
7. CONNECTOR UNMATING FORCES: 3N MIN.;

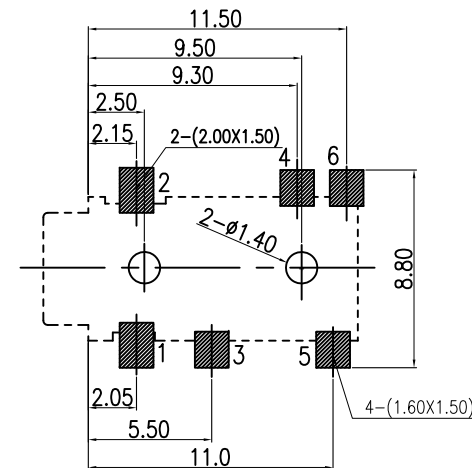

P.C.B LAYOUT

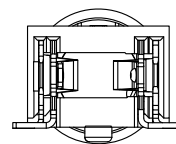
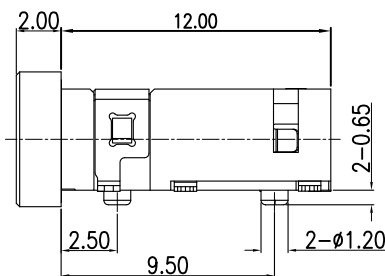
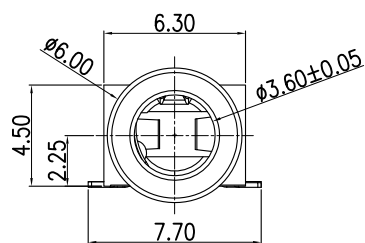
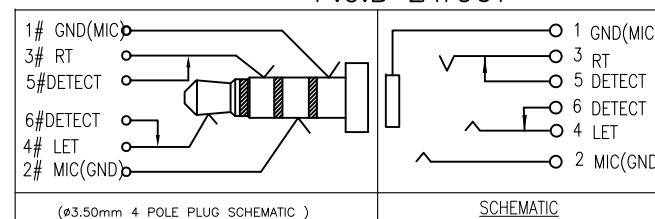
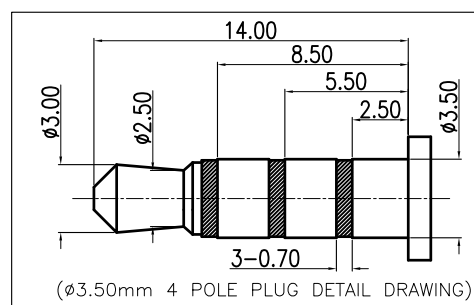
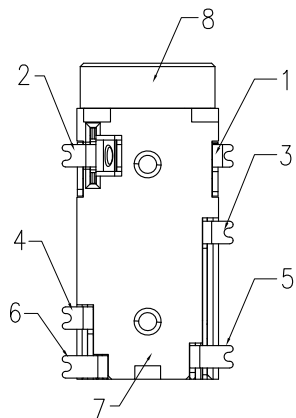

8	COVER	PHOSPHOR BRONZE	1	Ni-Plating	TOLERANCE							
7	HOUSING	PA9T	1	BLACK	UNLESS SPECIFIED							
6	TERMINAL 6#	PHOSPHOR BRONZE	1	Ni/Au-Plating	UP TO 5mm: ±0.1	ANGULAR						
5	TERMINAL 5#	PHOSPHOR BRONZE	1	Ni/Au-Plating	ABOVE 5mm: ±0.2	±1°						
4	TERMINAL 4#	PHOSPHOR BRONZE	1	Ni/Au-Plating	TITLE:PHONE JACK		UNIT : MM	ROHS	DWN			
3	TERMINAL 3#	PHOSPHOR BRONZE	1	Ni/Au-Plating	MODEL: PJ-3106AC1		SCALE: 1:1	COMPLIANT	CHK'D			
2	TERMINAL 2#	PHOSPHOR BRONZE	1	Ni/Au-Plating					APPD			
1	TERMINAL 1#	PHOSPHOR BRONZE	1	Ni/Au-Plating								
NO.	PART NAME	MATERIAL	QTY	FINISHING	 DONGGUANG HAOYU ELECTRONICS CO., LTD 东莞市弘皓电子有限公司			PRO.AGL:	 	REV :A0		

X-ON Electronics

Largest Supplier of Electrical and Electronic Components

Click to view similar products for [Phone Connectors](#) category:

Click to view products by [HOOYA](#) manufacturer:

Other Similar products are found below :

[R4F](#) [14412GX](#) [E12BPKG](#) [MT333X](#) [171-3302-EX](#) [NC3MG-V](#) [NP2RX-AU-SILENT-D](#) [JM2PB-AU BULK](#) [S2674](#) [280L](#) [RJ5VI-S](#) [TM1R-AU](#) [TM2PJ-AU](#) [TM2PJ-AU BULK](#) [TS3PBJ-AU](#) [TS3PBMJ-AU](#) [MP-101](#) [54B](#) [T10711](#) [MT334F](#) [NJ3FP6F-P](#) [NPX-PROMO](#) [JS3PB-AU BULK](#) [XMT332A](#) [114BPCSX](#) [CMT334B](#) [AA0-A4830-A00](#) [PJ-218](#) [PJ-320-3P SMT](#) [PJ-321A](#) [PJ-393-8P](#) [KH-PJ-327D-SMT](#) [PJ-320D](#) [PJ-3106M](#) [PJ-376](#) [PJ-368](#) [PJ-624](#) [PJ-339](#) [PJ-3200B](#) [RCJ-017](#) [PJ-307B-1.3-01](#) [PJ-324](#) [PJ-324M](#) [PJ-313D](#) [PJ-313](#) [PJ-227](#) [PJ-3106AC1](#) [PJ-3505A](#) [PJ-321](#) [KH-PJ-307-5P](#)