

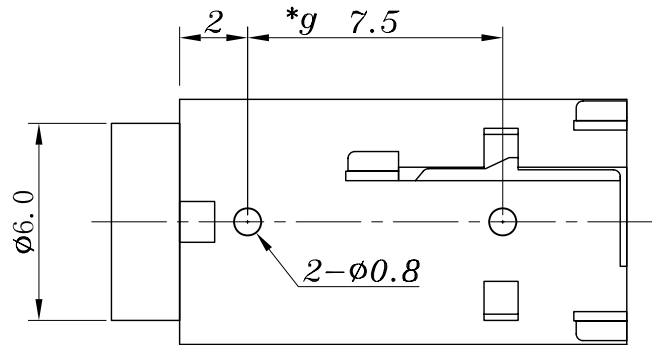

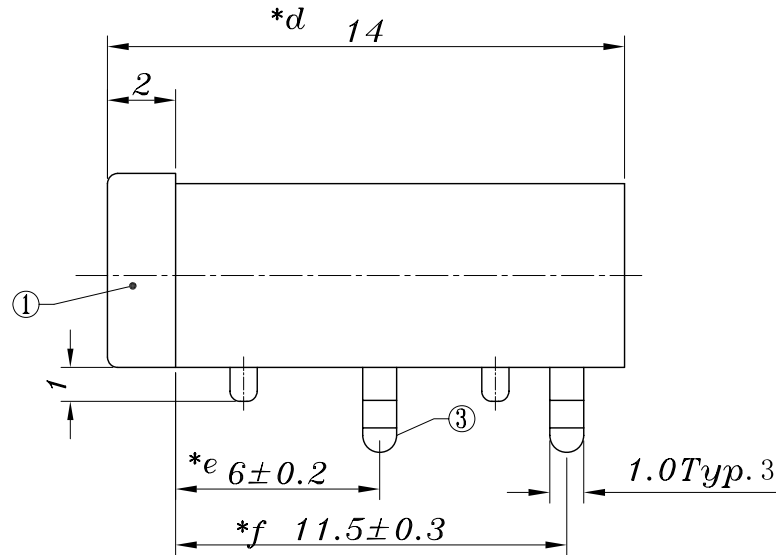

SCHMATIC

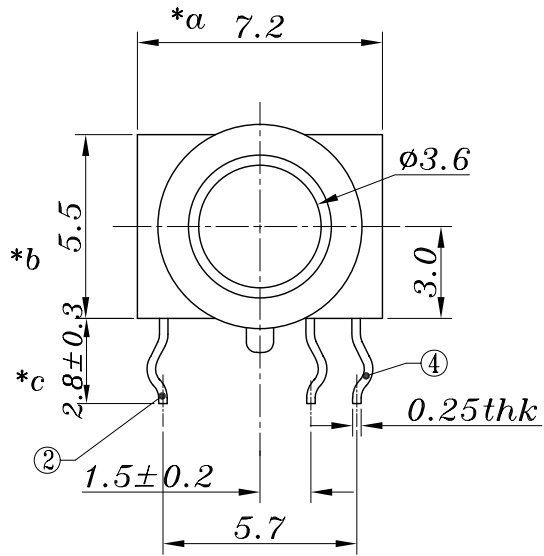
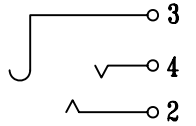
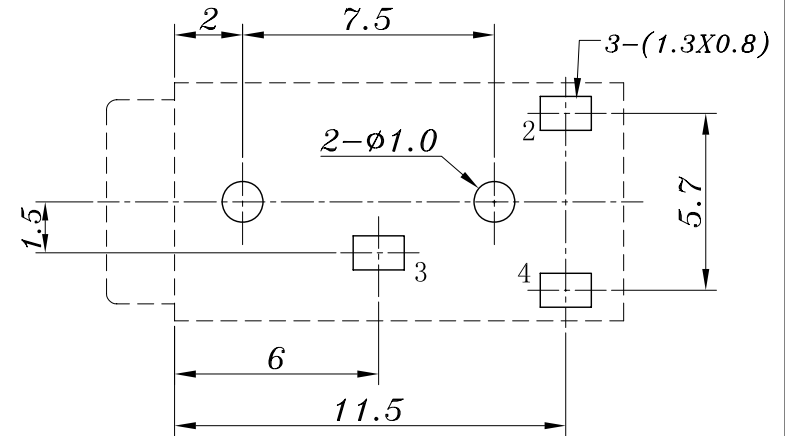

P.C.B LAYOUT  
TOP VIEW



				TOLERANCE UNLESS SPECIFIED							
				UP TO 5mm: ±0.1	ANGULAR	1					
				ABOVE 5mm: ±0.2	±1°	NO	DATE	REVISIONS		BY	APPD
4	4#CONTACT FOOT	PBS	1	Ag-PLATED	TITLE: PHONE JACK			UNIT : MM	ROHS	DWN	
3	3#CONTACT FOOT	PBS	1	Ag-PLATED	MODEL: PJ-368-G			SCALE: 1:1	COMPLIANT	CHK'D	
2	2#CONTACT FOOT	PBS	1	Ag-PLATED	 <b>HAOYU(HONGKONG)LIMITED</b> 皓宇(香港)有限公司			APPD			
1	HOUSING	PBT	1	BLACK				PRO.AGL:  		REV :A0	
NO.	PART NAME	MATERIAL	QTY	FINISHING							

## X-ON Electronics

Largest Supplier of Electrical and Electronic Components

*Click to view similar products for [Phone Connectors](#) category:*

*Click to view products by [HOOYA](#) manufacturer:*

Other Similar products are found below :

[R4F](#) [14412GX](#) [E12BPKG](#) [MT333X](#) [171-3302-EX](#) [NC3MG-V](#) [NP2RX-AU-SILENT-D](#) [JM2PB-AU BULK](#) [S2674](#) [280L](#) [RJ5VI-S](#) [TM1R-AU](#) [TM2PJ-AU](#) [TM2PJ-AU BULK](#) [TS3PBJ-AU](#) [TS3PBMJ-AU](#) [MP-101](#) [54B](#) [T10711](#) [MT334F](#) [NJ3FP6F-P](#) [NPX-PROMO](#) [JS3PB-AU BULK](#) [XMT332A](#) [114BPCSX](#) [CMT334B](#) [AA0-A4830-A00](#) [PJ-218](#) [PJ-320-3P SMT](#) [PJ-321A](#) [PJ-393-8P](#) [KH-PJ-327D-SMT](#) [PJ-320D](#) [PJ-3106M](#) [PJ-376](#) [PJ-624](#) [PJ-339](#) [PJ-3200B](#) [RCJ-017](#) [PJ-307B-1.3-01](#) [PJ-324](#) [PJ-324M](#) [PJ-313D](#) [PJ-313](#) [PJ-227](#) [PJ-343 Red](#) [PJ-3106AC1](#) [PJ-3505A](#) [PJ-321](#) [KH-PJ-307-5P](#)