

ROHS

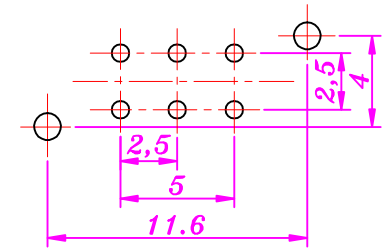

HAOYU

SCHEMATIC

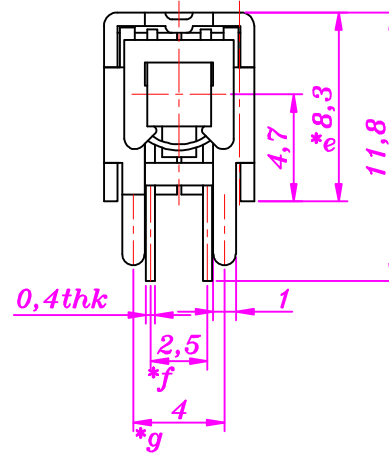
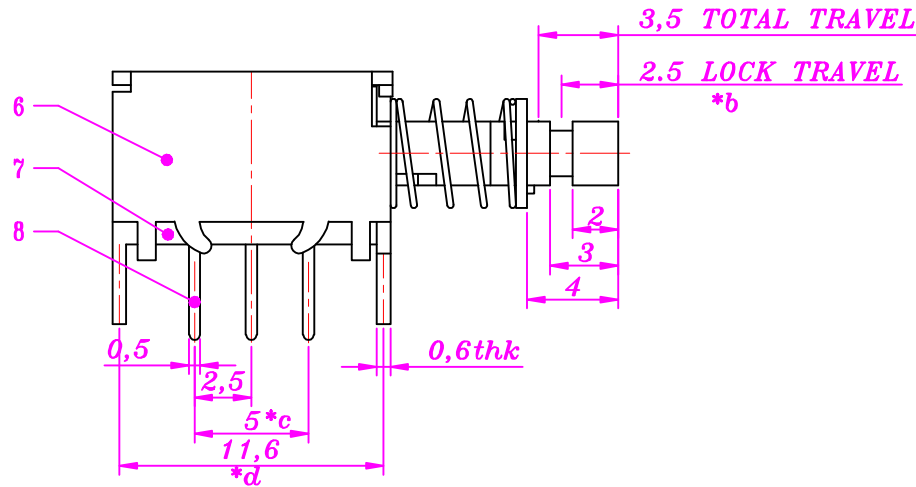
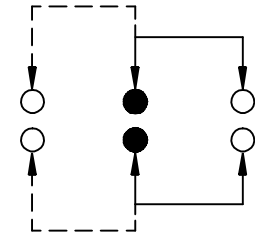
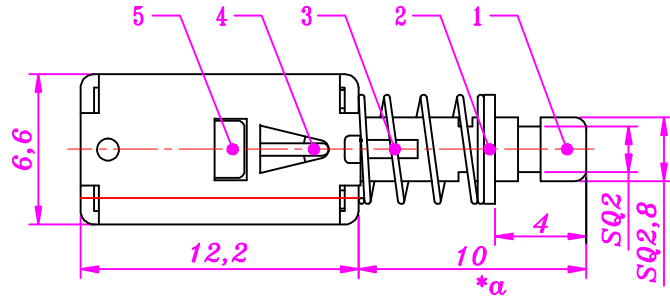

PCB LAYOUT

9	CONTACT CLIP	PHOSPHOR BRONZE	2	Ag CLAD
8	TERMINAL	BRASS	6	Ag-PLATED
7	BASE	PHENOLIC RESIN	1	NATURAL
6	FRAME	STEEL	1	Ni-PLATED
5	SPRING PLATE	PHOSPHOR BRONZE	1	NATURAL
4	CAM STICK	PHOSPHOR BRONZE	1	NATURAL
3	SPRING	SUS	1	Ni-PLATED
2	BLOCK	STEEL	1	Ni-PLATED
1	KNOB	PA66	1	
NO.	PART NAME	MATERIAL	QTY	FINISHING

TOLERANCE								
UNLESS SPECIFIED								
UP TO 5mm: ±0.1	ANGULAR	1	2016.4.25	更新图纸				
ABOVE 5mm: ±0.2	±1°	NO	DATE	REVISIONS		BY	APPD	
TITLE: PUSH SWITCH			UNIT : MM	ROHS	DWN			
MODEL: PS-22E05-S PA66柄			SCALE: 1:1	COMPLIANT	CHK'D			
 HAOYU(HONGKONG)LIMITED 皓宇(香港)有限公司				APPD				
				PRO.AGL:			REV :A1	

X-ON Electronics

Largest Supplier of Electrical and Electronic Components

Click to view similar products for [Pushbutton Switches](#) category:

Click to view products by [HOOYA](#) manufacturer:

Other Similar products are found below :

[8971K1133](#) [LW2L-M1C20M-A](#) [M22-D-R-GB0/K11](#) [67021K512](#) [701PB580](#) [7199K101](#) [810K12910](#) [810KSV30B](#) [FLT 2U EE 01A](#)
[MML21EA2ADK](#) [MML21KA3ABK](#) [MML23KA3AC05K-001](#) [MML23KW3AA01W](#) [8418K2](#) [8442K3](#) [8450K1](#) [860K11911T01A](#) [861901](#)
[861K11911T01A07](#) [861K13810T00A14](#) [861K13911](#) [8646AB6X718UL](#) [9533CD4+U574+U4922](#) [99-450.837](#) [99-453.837](#)
[A2PMA1X03EC56](#) [A3A-7310](#) [A3A-7340](#) [12037A2ULCSA](#) [1203A2UL](#) [ABGW410-R](#) [1211390004](#) [ABN400-R](#) [121382](#) [1213C3](#) [HE3B-M2](#)
[1211500044](#) [121194](#) [1212MRA](#) [1232A6NF](#) [1241.1183.7047](#) [121489](#) [1223A2ULCSA](#) [1241.1183.8000](#) [1241.1183.8029](#) [D5P-MT4](#)
[13435AG](#) [13445AD29GX768](#) [AG23-L2](#) [AH165-2SGLG1TE3](#)