

HAOYU

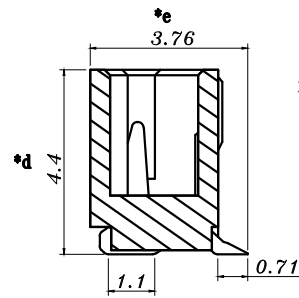

截面 A-A

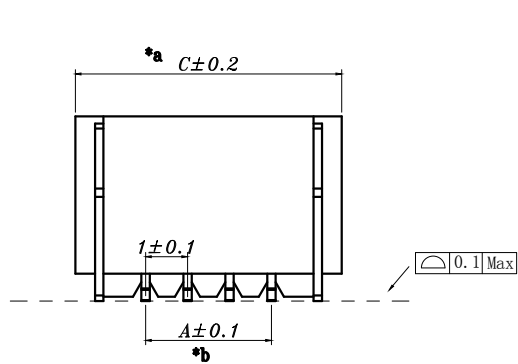
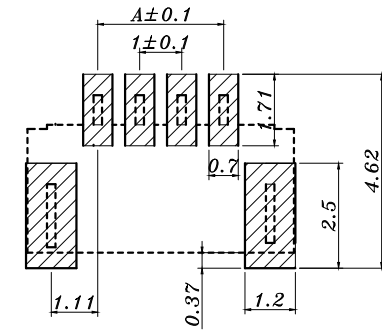
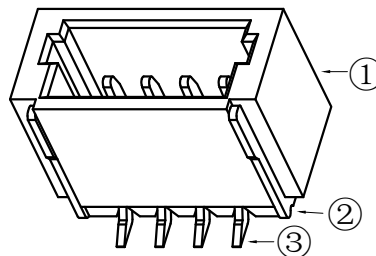
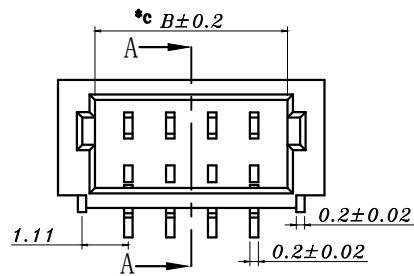
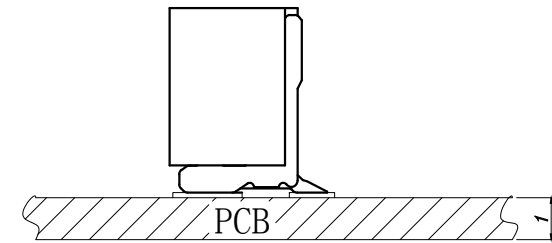

印制线路板

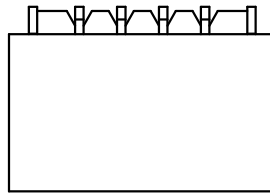

Circuits	Dimensions (mm)			Circuits	Dimensions (mm)		
	A	B	C		A	B	C
SH1000-LT-02	1.0	2.6	4.30	SH1000-LT-12	11.0	12.6	14.30
SH1000-LT-03	2.0	3.6	5.30	SH1000-LT-13	12.0	13.6	15.30
SH1000-LT-04	3.0	4.6	6.30	SH1000-LT-14	13.0	14.6	16.30
SH1000-LT-05	4.0	5.6	7.30	SH1000-LT-15	14.0	15.6	17.30
SH1000-LT-06	5.0	6.6	8.30	SH1000-LT-16	15.0	16.6	18.30
SH1000-LT-07	6.0	7.6	9.30	SH1000-LT-17	16.0	17.6	19.30
SH1000-LT-08	7.0	8.6	10.30	SH1000-LT-18	17.0	18.6	20.30
SH1000-LT-09	8.0	9.6	11.30	SH1000-LT-19	18.0	19.6	21.30
SH1000-LT-10	9.0	10.6	12.30	SH1000-LT-20	19.0	20.6	22.30
SH1000-LT-11	10.0	11.6	13.30				

					TOLERANCE UNLESS SPECIFIED						
					UP TO 5mm: ±0.1	ANGLES ±1.5°					
					ABOVE 5mm: ±0.2		NO	DATE	REVISIONS	BY APPD	
					TITLE: CONNECTOR		UNIT : MM	ROHS COMPLIANT	DWN		
3	CONTACT FOOT	PBS	XX	SN-PLATED	PART NO.: SH1000-LT-XX		SCALE: 2:1	CHK'D			
2	CONTACT	PBS	2	SN-PLATED	HAOYU(HONGKONG)LIMITED 皓宇(香港)有限公司					APPD	
1	HOUSING	LCP	1							PRO.AGL:	REV :A0
NO.	PART NAME	MATERIAL	QTY	FINISHING							

X-ON Electronics

Largest Supplier of Electrical and Electronic Components

Click to view similar products for [Headers & Wire Housings](#) category:

Click to view products by [HOOYA](#) manufacturer:

Other Similar products are found below :

[57102-F02-18ULF](#) [58102-G61-06LF](#) [0009485154](#) [009176003701906](#) [0050291907](#) [00-9021-0611-00-339](#) [02.125.8002.8](#) [609-3404](#) [61062-3](#)
[622-0430](#) [622-3653LF](#) [63453-116](#) [636-1030](#) [636-1427](#) [636-3427](#) [636-4007](#) [641938-9](#) [644827-2](#) [65495-038](#) [65692-001LF](#) [65781-018](#)
[65781-047](#) [65817-010LF](#) [65817-015LF](#) [66207-023LF](#) [67016-026LF](#) [67095-007LF](#) [68631-112](#) [68645-018](#) [68648-049](#) [699319-000](#)
[70.362.1628.0](#) [70-4210](#) [70-4226B](#) [70-4853B](#) [707-5020](#) [707-5028](#) [71.350.2428.0](#) [71961-016LF](#) [733-134](#) [754199-000](#) [760-3052](#) [787-8014-00](#)
[FCN-367T-T012/H](#) [80.063.4001.1](#) [800-90-001-10-001000](#) [800-90-010-10-002000](#) [801-43-002-10-013000](#) [801-43-006-10-002000](#)
[803-41-018-10-001000](#)