

HAOYU

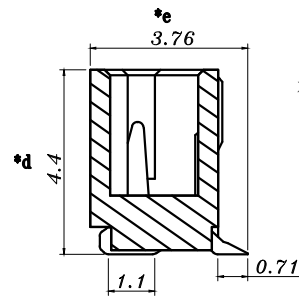

截面 A-A

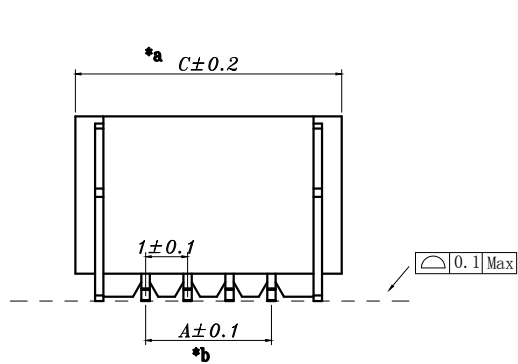
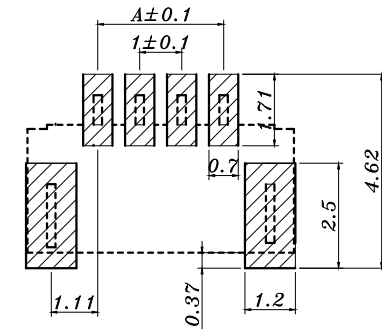
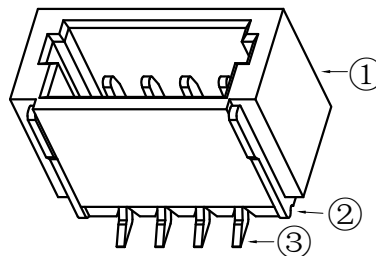
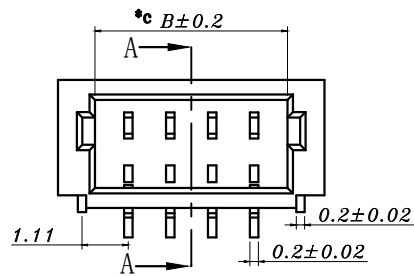
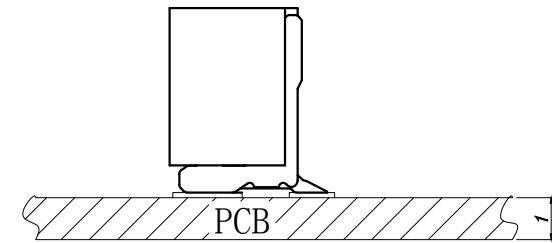

印制线路板

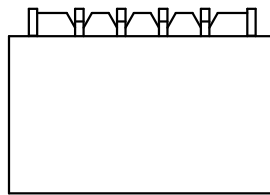

| Circuits | Dimensions (mm) | | | Circuits | Dimensions (mm) | | |
|--------------|-----------------|------|-------|--------------|-----------------|------|-------|
| | A | B | C | | A | B | C |
| SH1000-LT-02 | 1.0 | 2.6 | 4.30 | SH1000-LT-12 | 11.0 | 12.6 | 14.30 |
| SH1000-LT-03 | 2.0 | 3.6 | 5.30 | SH1000-LT-13 | 12.0 | 13.6 | 15.30 |
| SH1000-LT-04 | 3.0 | 4.6 | 6.30 | SH1000-LT-14 | 13.0 | 14.6 | 16.30 |
| SH1000-LT-05 | 4.0 | 5.6 | 7.30 | SH1000-LT-15 | 14.0 | 15.6 | 17.30 |
| SH1000-LT-06 | 5.0 | 6.6 | 8.30 | SH1000-LT-16 | 15.0 | 16.6 | 18.30 |
| SH1000-LT-07 | 6.0 | 7.6 | 9.30 | SH1000-LT-17 | 16.0 | 17.6 | 19.30 |
| SH1000-LT-08 | 7.0 | 8.6 | 10.30 | SH1000-LT-18 | 17.0 | 18.6 | 20.30 |
| SH1000-LT-09 | 8.0 | 9.6 | 11.30 | SH1000-LT-19 | 18.0 | 19.6 | 21.30 |
| SH1000-LT-10 | 9.0 | 10.6 | 12.30 | SH1000-LT-20 | 19.0 | 20.6 | 22.30 |
| SH1000-LT-11 | 10.0 | 11.6 | 13.30 | | | | |

| | | | | | | | | | | | | | | |
|------------|------------------|-----------------|------------|------------------|---|--------------|----|------------|----------------|-----|----|----------|--|--|
| | | | | | TOLERANCE UNLESS SPECIFIED | | | | | | | | | |
| | | | | | UP TO 5mm: ±0.1 | ANGLES ±1.5° | | | | | | | | |
| | | | | | ABOVE 5mm: ±0.2 | | NO | DATE | REVISIONS | | BY | APPD | | |
| | | | | | TITLE: CONNECTOR | | | UNIT : MM | ROHS COMPLIANT | DWN | | | | |
| 3 | CONTACT FOOT | PBS | XX | SN-PLATED | PART NO.: SH1000-LT-XX | | | SCALE: 2:1 | CHK'D | | | | | |
| 2 | CONTACT | PBS | 2 | SN-PLATED | HAOYU(HONGKONG)LIMITED 皓宇(香港)有限公司 | | | | | | | APPD | | |
| 1 | HOUSING | LCP | 1 | | | | | | | | | PRO.AGL: | | |
| NO. | PART NAME | MATERIAL | QTY | FINISHING | | | | | | | | | | |

X-ON Electronics

Largest Supplier of Electrical and Electronic Components

Click to view similar products for [Headers & Wire Housings](#) category:

Click to view products by [HOOYA](#) manufacturer:

Other Similar products are found below :

[57102-F02-18ULF](#) [58102-G61-06LF](#) [0009485154](#) [009176003701906](#) [0050291907](#) [00-9021-0611-00-339](#) [02.125.8002.8](#) [609-3404](#) [61062-3](#)
[622-0430](#) [622-3653LF](#) [63453-116](#) [636-1030](#) [636-1427](#) [636-3427](#) [636-4007](#) [641938-9](#) [644827-2](#) [65495-038](#) [65692-001LF](#) [65781-018](#)
[65781-047](#) [65817-010LF](#) [65817-015LF](#) [66207-023LF](#) [67016-026LF](#) [67095-007LF](#) [68631-112](#) [68645-018](#) [68648-049](#) [699319-000](#)
[70.362.1628.0](#) [70-4210](#) [70-4226B](#) [70-4853B](#) [707-5020](#) [707-5028](#) [71.350.2428.0](#) [71961-016LF](#) [733-134](#) [754199-000](#) [760-3052](#) [787-8014-00](#)
[FCN-367T-T012/H](#) [80.063.4001.1](#) [800-90-001-10-001000](#) [800-90-010-10-002000](#) [801-43-002-10-013000](#) [801-43-006-10-002000](#)
[803-41-018-10-001000](#)