

HAOYU

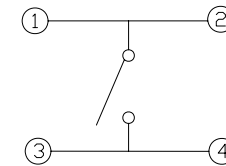

CIRCUIT DIAGRAM

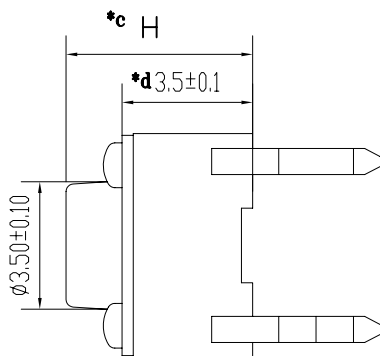
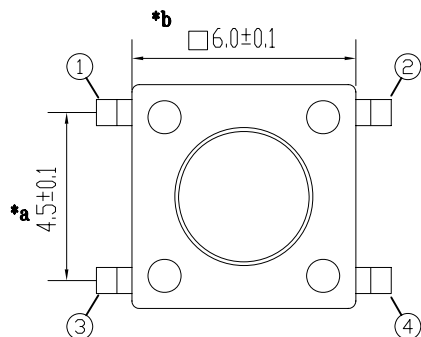
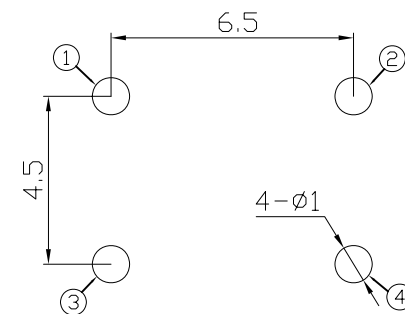
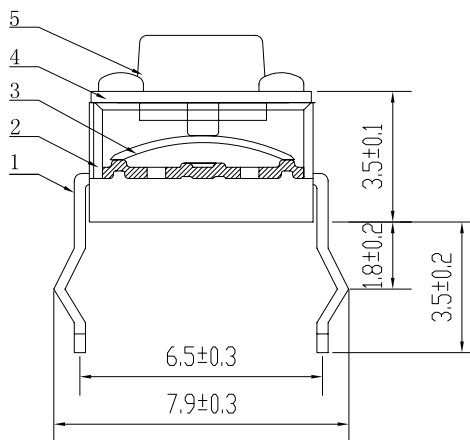
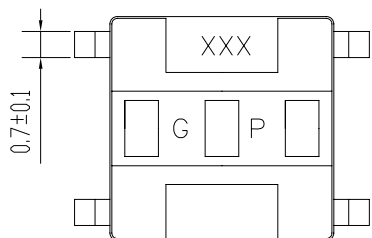

P . C . B LAYOUT

H=XX mm

					TOLERANCE UNLESS SPECIFIED						
					UP TO 5mm: ±0.1	ANGULAR	A1	2023.2.17	更新图纸	WM	
					ABOVE 5mm: ±0.2	±1°	NO	DATE	REVISIONS	BY	APPD
1	TERMINAL	BRASS	1	Ag-PLATED				UNIT : MM	ROHS	DWN	
2	CASE	PA9T	1	BLACK	TITLE: TACT SWITCH			SCALE: 1:1	COMPLIANT	CHK'D	
3	CONTACT	SUS301	1	Ag-PLATED	MODEL: TC-00104-070C						
4	COVER	BRASS	1	Sn-PLATED	DONGGUANG HAOYU ELECTRONICS CO., LTD 东莞市弘皓电子有限公司				APPD		
5	KNOB	PA9T	1	BLACK							
NO.	PART NAME	MATERIAL	QTY	FINISHING				PRO.AGL:		REV :A1	

X-ON Electronics

Largest Supplier of Electrical and Electronic Components

Click to view similar products for [Tactile Switches](#) category:

Click to view products by [HOOYA](#) manufacturer:

Other Similar products are found below :

[6407-250V-25273P](#) [ADTSA62NV](#) [B3F-3123](#) [1977177-8](#) [1977266-1](#) [ADTSA63NV](#) [ADTSM21NSVTR](#) [ADTSM25RVTR](#) [ADTSM32NVTR](#)
[ADTSMW64RV](#) [1977120-6](#) [FSMRA4JHA04](#) [GS4.70F300QP](#) [KSC241J SP DELTA LFS](#) [3FTL600RAS](#) [3FTL640RAS](#) [6407-250V-25343P](#)
[ADTSM31NVTR](#) [2-1977120-7](#) [TSJW-5.2-260-TR](#) [Y651050400P](#) [KMT011MNGJLHS](#) [70-201.0](#) [ADTSG648NV](#) [ADTSM62KSVTR](#)
[ADTSM648NV](#) [95C06E3RAT](#) [3ATH9Q](#) [FSMRA8JHA04](#) [HARS0073](#) [Y33R411N9FPLFT](#) [Y33R51139FPLFT](#) [Y31C01402FPLFS](#)
[PTS645SK50SMTR92](#) [ADTSM32NVB](#) [KMS233GPWTLFG](#) [Y78B64124FP](#) [Y31CJ244KFP LFS](#) [Y96D113G0FP LFS](#) [Y33A812C5FP LFT](#)
[Y56B2D120FP LFS](#) [Y31C5144KFP LFS](#) [PTS645 DVM83-BN125-2 LFS](#) [B3W 1000G](#) [KSC621G OL LFS](#) [B3F 1002C](#) [B3F 0047H](#) [B3W](#)
[1002C](#) [B3F 5001G](#) [B3W 1100C](#)