

SCHEMATIC

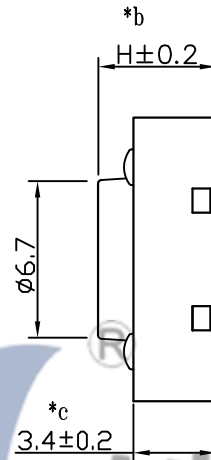

SPECIFICATION

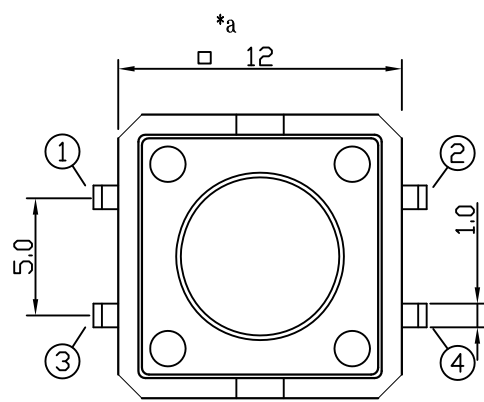

1. Rating : DC12V 50mA.
2. Contact resistance: $\leq 100\Omega$.
3. Insulation resistance: $\geq 100M\Omega$ (DC250V).
4. Withstanding voltage: 250VAC .
5. Operating Force: $250 \pm 80gf$
6. Travel: $0.25 \pm 0.1mm$.
7. life test: 5,0000 cycles.
8. Operation temperature range: $-25^{\circ}C \sim 85^{\circ}C$.
9. Sign"* "is importance dimension.

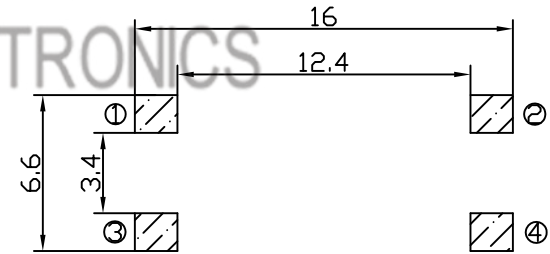
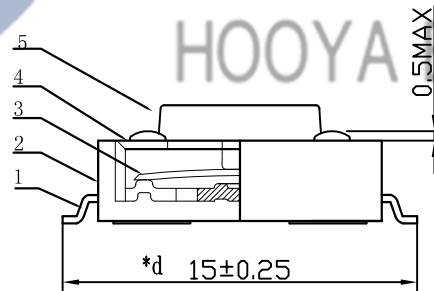
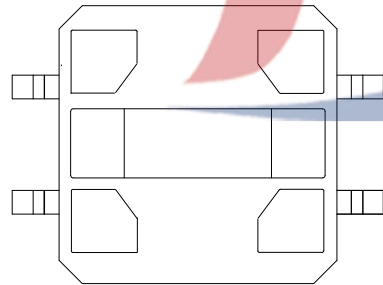
TEL:0769-82310510-867



P.C.B LAYOUT

H=7.3mm

| | | | | TOLERANCE UNLESS SPECIFIED | | | | | | |
|-----|-----------|----------|-----|----------------------------|---|----|--|----------------|-----|------|
| | | | | <1.5: ±0.1mm | ANGULAR | 1 | | | | |
| | | | | >1.5~5.0: ±0.25mm | ±1° | NO | DATE | REVISIONS | BY | APPD |
| | | | | >5.0: ±0.3mm | | | | | | |
| 5 | STEM | PPA | 1 | BLACK | TITLE: SLIDE SWITCH | | UNIT : MM | ROHS COMPLIANT | DWN | |
| 4 | COVER | SUS | 1 | WHITE | MODEL: TC-06121-073E-01 | | SCALE: 1:1 | CHK'D | | |
| 3 | CONTACT | SUS | 1 | Ag-Plated |  DONGGUANG HAOYU ELECTRONICS CO., LTD 东莞市弘皓电子有限公司 | | APPD | | | |
| 2 | CASE | PPA | 1 | BLACK | | | PRO.AGL:   | REV :A1 | | |
| 1 | TERMINAL | BRASS | 4 | Ag-Plated | | | | | | |
| NO. | PART NAME | MATERIAL | QTY | FINISHING | | | | | | |

X-ON Electronics

Largest Supplier of Electrical and Electronic Components

Click to view similar products for [Tactile Switches](#) category:

Click to view products by [HOOYA](#) manufacturer:

Other Similar products are found below :

[6407-250V-25273P](#) [ADTSA62NV](#) [B3F-3123](#) [1977177-8](#) [1977266-1](#) [ADTSA63NV](#) [ADTSM21NSVTR](#) [ADTSM25RVTR](#) [ADTSM32NVTR](#)
[ADTSMW64RV](#) [1977120-6](#) [FSMRA4JHA04](#) [GS4.70F300QP](#) [KSC241J SP DELTA LFS](#) [3FTL600RAS](#) [3FTL640RAS](#) [6407-250V-25343P](#)
[ADTSM31NVTR](#) [2-1977120-7](#) [TSJW-5.2-260-TR](#) [Y651050400P](#) [KMT011MNGJLHS](#) [70-201.0](#) [ADTSG648NV](#) [ADTSM62KSVTR](#)
[ADTSM648NV](#) [95C06E3RAT](#) [3ATH9Q](#) [FSMRA8JHA04](#) [HARS0073](#) [Y33R411N9FPLFT](#) [Y33R51139FPLFT](#) [Y31C01402FPLFS](#)
[PTS645SK50SMTR92](#) [ADTSM32NVB](#) [KMS233GPWTLFG](#) [Y78B64124FP](#) [Y31CJ244KFP LFS](#) [Y96D113G0FP LFS](#) [Y33A812C5FP LFT](#)
[Y56B2D120FP LFS](#) [Y31C5144KFP LFS](#) [PTS645 DVM83-BN125-2 LFS](#) [B3W 1000G](#) [KSC621G OL LFS](#) [B3F 1002C](#) [B3F 0047H](#) [B3W](#)
[1002C](#) [B3F 5001G](#) [B3W 1100C](#)