

HAOYU

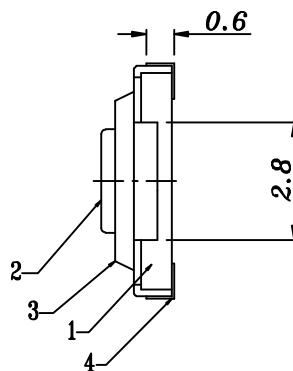

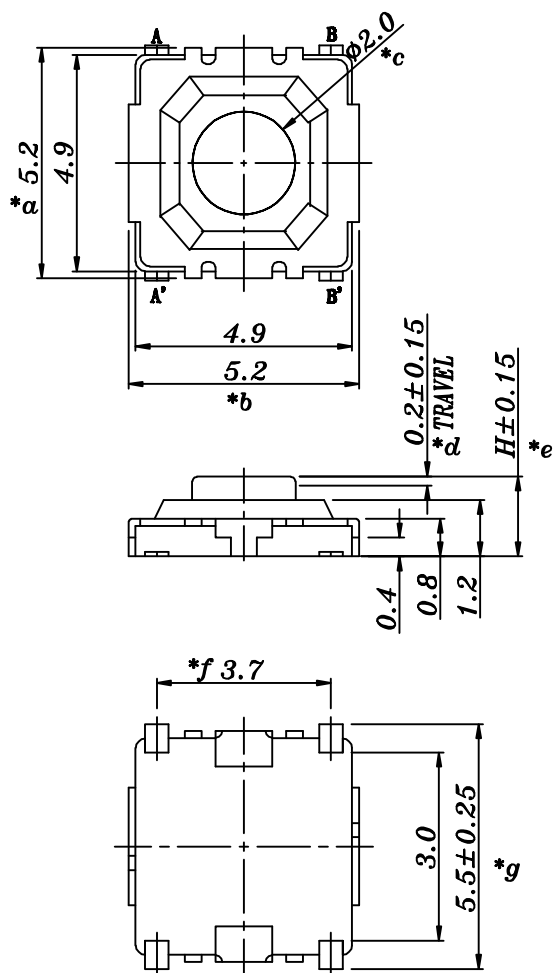

CIRCUIT DIAGRAM

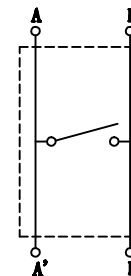

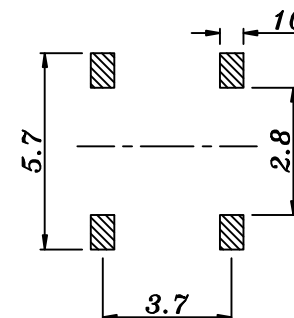
PCB LAYOUT



H=XXmm

				TOLERANCE UNLESS SPECIFIED							
				UP TO 5mm: ± 0.1	ANGULAR	1	2016.6.6	增加 TRAVEL 尺寸标识			
				ABOVE 5mm: ± 0.2	$\pm 1^\circ$	NO	DATE	REVISIONS		BY	APPD
4	CONTACT FOOT	BRASS	4	Ag-Plated	TITLE: TACT SWITCH		UNIT : MM	ROHS	DWN		
3	COAT	STAINLESS STEEL	1	Ni-Plated	MODEL: TS-1187U-015C		SCALE: 1:1	COMPLIANT	CHK'D		
2	BUTTON	BRASS	1	Ni-Plated	 HAOYU(HONGKONG)LIMITED 皓宇(香港)有限公司		APPD				
1	HOUSING	PA6T	1				PRO.AGL:			REV :A1	
NO.	PART NAME	MATERIAL	QTY	FINISHING							

X-ON Electronics

Largest Supplier of Electrical and Electronic Components

Click to view similar products for [Tactile Switches](#) category:

Click to view products by [HOOYA](#) manufacturer:

Other Similar products are found below :

[5GTH92001](#) [5GTH9202242](#) [6407-250V-25273P](#) [ADTSA62NV](#) [ADTSA62RV](#) [B3F-3123](#) [1977177-8](#) [1977266-1](#) [ADTSA63NV](#)
[ADTSM21NSVTR](#) [ADTSM25RVTR](#) [ADTSM32NVTR](#) [ADTSMW64RV](#) [FSMRA4JHA04](#) [GS4.70F300QP](#) [KSC241J SP DELTA LFS](#)
[3FTL600RAS](#) [3FTL640RAS](#) [Y96K132V0FPLFS](#) [5GTH9658222](#) [6407-250V-25343P](#) [ADTSM31NVTR](#) [2-1977120-7](#) [TSJW-5.2-260-TR](#)
[KMT011MNGJLHS](#) [B3WN6002S](#) [70-201.0](#) [ADTSG648NV](#) [ADTSM62KSVTR](#) [ADTSM648NV](#) [95C06E3RAT](#) [5GTH96561](#) [3ATH9Q](#)
[FSMRA8JHA04](#) [HARS0073](#) [Y33R411N9FPLFT](#) [Y31C01402FPLFS](#) [PTS645SK50SMTR92](#) [ADTSM32NVB](#) [KMS233GPWTLFG](#)
[Y78B64124FP](#) [Y96D113G0FP LFS](#) [Y33A812C5FP LFT](#) [Y56B2D120FP LFS](#) [PTS645 DVM83-BN125-2 LFS](#) [B3W 1000G](#) [KSC621G OL](#)
[LFS](#) [B3F 1002C](#) [B3F 0047H](#) [B3F 1000G](#)