

SMD CRYSTAL UNIT SPECIFICATIONS

Customer	
Customer P/N	
Product	3225 Seam Sealing Crystal
Nominal Frequency	11.059200MHz
HOSONIC P/N	E3SB11E0X000FE
Version	10C0
Issue Date	2017/12/11

HOSONIC		
Drawn	Checked	Approved
LUCY	ZOE	JOHN

Approved By Customer : _____



HOSONIC ELECTRONIC CO., LTD.



Revised Record

Rev.	Rev. Date	Item	Content	Remark
1.0	2017-12-11		Initial released	

I ELECTRICAL PARAMETERS

No.	Item	Symb.	Electrical Specification				Remark
			Min.	Typ.	Max.	Units	
1	Nominal Frequency	F0	11.059200			MHz	
2	Mode of Vibration		Fundamental				
3	Frequency Tolerance	$\Delta F/F0$	-30	-	30	ppm	At 25°C±3°C
4	Operating Temperature Range	T _{OPR}	-40	-	105	°C	
5	Frequency Stability (over operating temperature)	TC	-30	-	30	ppm	Ref. to 25°C
6	Storage Temperature	T _{STG}	-55	-	125	°C	
7	Load capacitance	CL	-	20	-	pF	
8	Equivalent Series Resistance	ESR	-	-	120	Ω	
9	Drive Level	DL	-	100	200	μW	
10	Insulation Resistance	IR	500	-	-	MΩ	At 100V _{DC}
11	Shunt Capacitance	C0	-	-	3	pF	
12	Aging Per Year	Fa	-2	-	2	ppm	First Year
13	Package type	HCX-3SB					

NOTE: Storage Temperature is only for the product itself, the temperature for the packing material is -4~40°C.

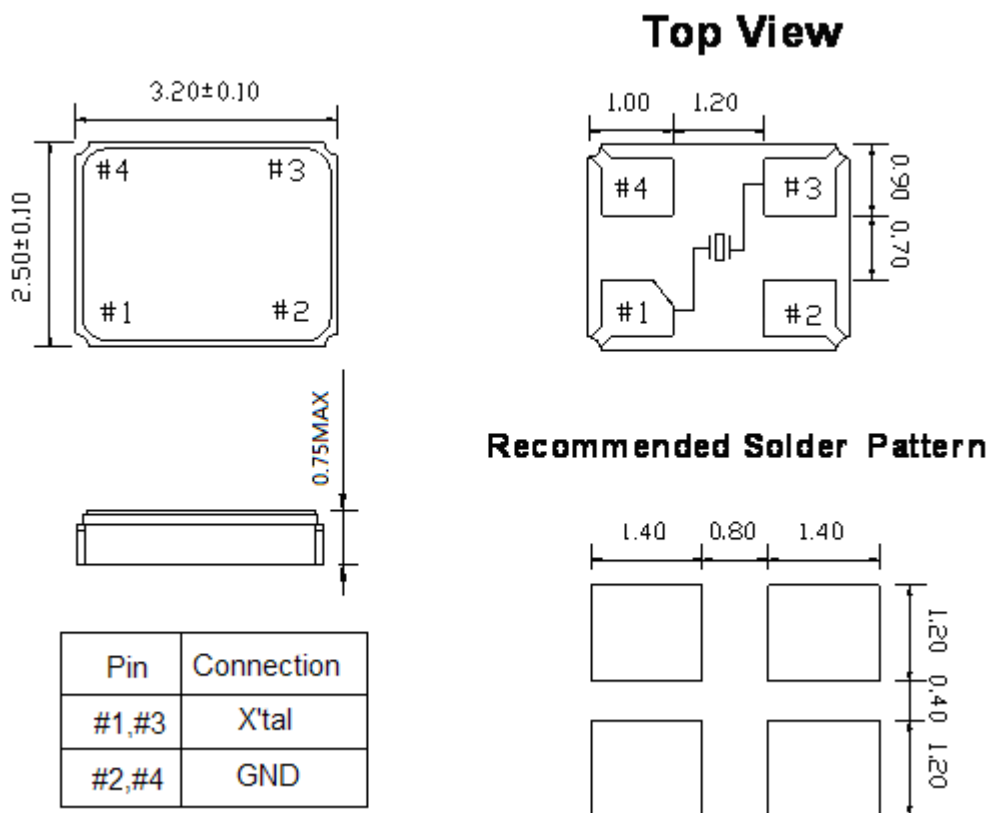
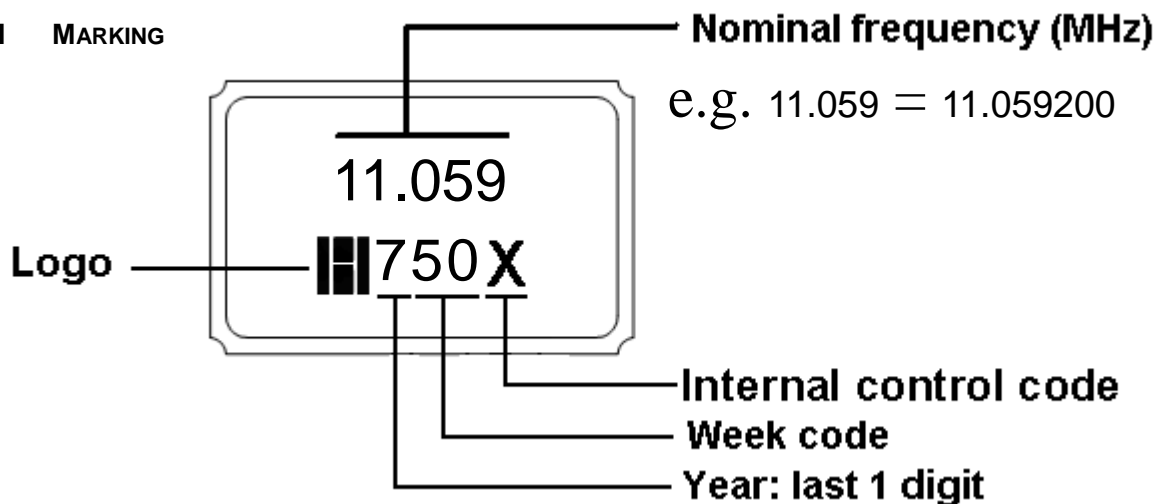
I OUTLINE DIMENSIONS (UNIT: mm)

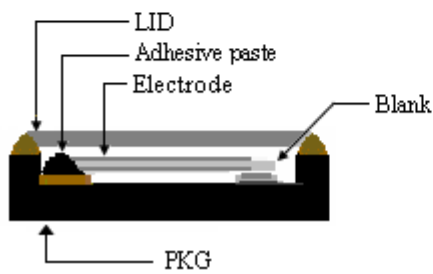
I MARKING

I PRODUCT LAYOUT

NO.	Part	Material	Remark
1	LID	KOVAR(Fe+Co+Ni alloy)	
2	PKG	Al ₂ O ₃	Base
3	Blank	SiO ₂	Quartz
4	Adhesive paste	Ag/Silicon	Support
5	Electrode	Noble metal	

I REFLOW PROFILES

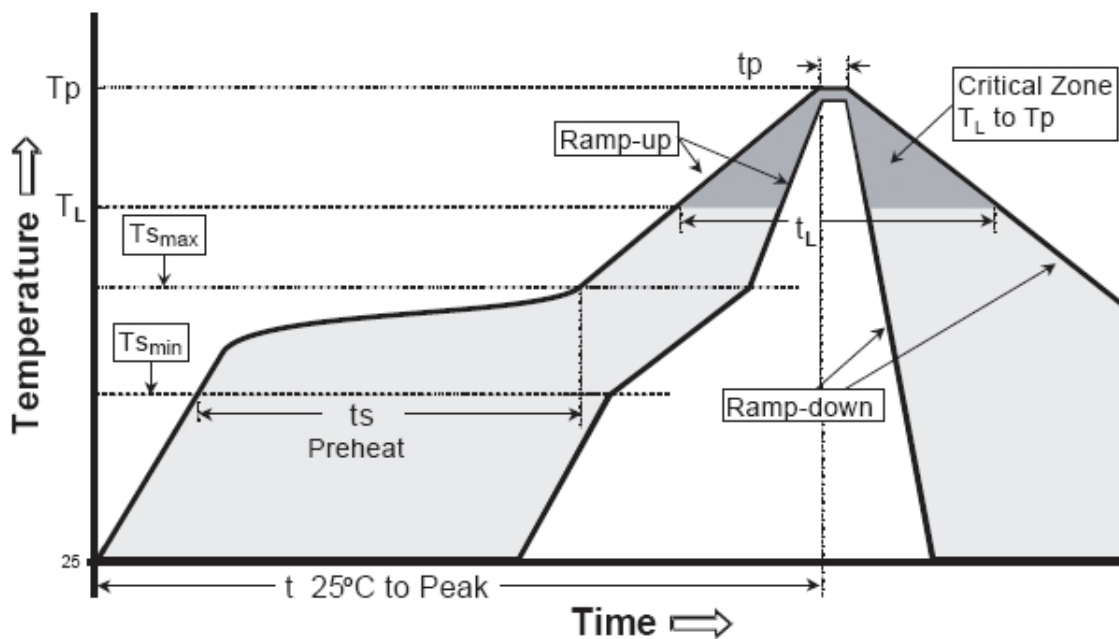
Profiles Feature	Pb-Free Assembly
Average Ramp-up Rate (Ts max to Tp)	3°C/second max.
Preheat <ul style="list-style-type: none"> ■ Temperature Min (Ts min) ■ Temperature Max (Ts max) ■ Time (ts min to ts max) 	125°C 200°C 60~180 seconds
Time maintained above <ul style="list-style-type: none"> ■ Temperature (T_L) ■ Time (t_L) 	217°C 60~150 seconds
Peak/Classification Temperature (Tp)	260°C
Time within 5°C of actual Peak Temperature (t _p)	20~40 seconds
Ramp-down rate	6°C/second max.
Time 25°C to Peak Temperature	8 minutes max.
Suggest reflow times	3 Times max



Remark: To reference JEDEC J-STD-020C

I PACKAGE(reference to EIA-481)

Tape Dimensions(unit : mm)

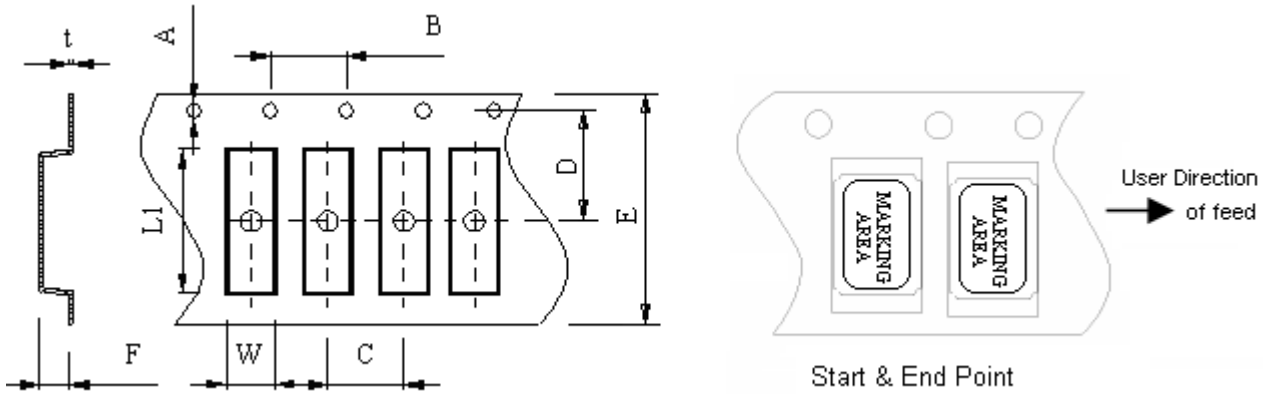

A	B	C	D	E	F	L1	W	t
1.50	4.0	4.0	3.5	8.0	1.0	3.4	2.7	0.3

Reel Dimensions(unit: mm)

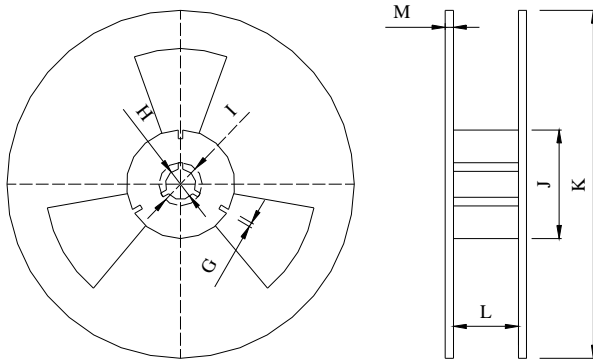

G	H	I	J	K	L	M
2.5	13.5	21.6	60.0	178	9.5	1.6

*3000pcs/Reel

Carton Dimension (unit : mm)



1 reel = 1 Inner box

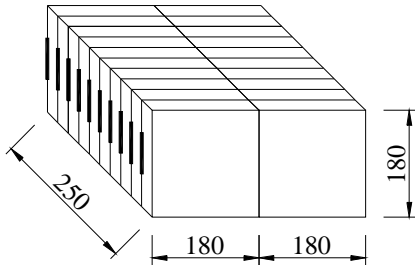

20 Inner boxes = 1 Carton

60kpcs = 1 Carton

I RELIABILITY SPECIFICATIONS

No.	Test Item	Test Conditions	Reference
1	High Temperature Storage	Temperature: $125^{\circ}\text{C} \pm 5^{\circ}\text{C}$ Time: 1000 ± 12 Hours	MIL-STD-883E-1016
2	Temperature Cycle	Temperature 1: $-55^{\circ}\text{C} \pm 5^{\circ}\text{C}$ Temperature 2: $125^{\circ}\text{C} \pm 5^{\circ}\text{C}$ Temperature change between T1 and T2 at soonest Run 1000 cycles, maintain T1 and T2 5minutes each in one cycle	JESD22 Method JA-104
3	Solder Heat Resistance	Pre-heat: 125°C 60~120 Seconds Solder Temperature: $260^{\circ}\text{C} \pm 5^{\circ}\text{C}$ Time: 30 Seconds	MIL-STD-202F 210 E
4	Drop Test	3 Times Free Fall from 75cm height table to 3cm thickness hard wood board	MIL-STD-202F-203B
5	High Temperature, High Humidity Storage	Temperature: $85^{\circ}\text{C} \pm 5^{\circ}\text{C}$ Relative Humidity: 80%~85% Time: 250Hours \pm 24 Hours	MIL-STD-202F-103B
6	Steam Aging	Temperature: $97^{\circ}\text{C} \pm 5^{\circ}\text{C}$ Time: 24 Hours 260°C solder pot to check solderability	MIL-STD-883 C-1008.2B
7	Solderability	Dip in flux 5~10 seconds Temperature: $245^{\circ}\text{C} \pm 5^{\circ}\text{C}$ Time: 10 Seconds	MIL-STD-202F-208H
8	Aging	Temperature: $85^{\circ}\text{C} \pm 5^{\circ}\text{C}$ Time: 250 ± 12 Hours	MIL-STD-202 F-108A
9	Thermal Shock	Temperature 1: $-55^{\circ}\text{C} \pm 5^{\circ}\text{C}$ Temperature 2: $125^{\circ}\text{C} \pm 5^{\circ}\text{C}$ Temperature change between T1 and T2: 5 seconds 100 cycles, maintain T1 and T2 for 30 minutes each in one cycle	MIL-STD-883E-1011.9B
10	Vibration	Frequency Range: 10Hz~2000Hz Amplitude: 1.5mm or 20G 4Hours in each direction, total 12Hours	MIL-STD-202F-204D

X-ON Electronics

Largest Supplier of Electrical and Electronic Components

Click to view similar products for [Crystals](#) category:

Click to view products by [Hosonic](#) manufacturer:

Other Similar products are found below :

[CX3225GB25000M0PPSZ1](#) [718-13.2-1](#) [MC405 32.0000K-R3:PURE SN](#) [7A-40.000MAAE-T](#) [FL2000085](#) [99-BU](#) [9B-15.360MBBK-B](#) [9C-7.680MBBK-T](#) [H10S-12.000-18-EXT-TR](#) [ABC2-6.000MHZ-D4Z-T](#) [ABLS-20.000MHZ-D2-T](#) [ABS071-32.768KHZ-6-T](#) [R38-32.768-12.5-5PPM-NPB](#) [BTD1062E05A-513](#) [21U15A-21.4MHZ](#) [RTX-781DF1-S-20.950](#) [LFXTAL066198Cutt](#) [9C-14.31818MBBK-T](#) [A-11.000MHZ-27](#) [ABL-27.000MHZ-B4Y-T](#) [ABM11-132-24.000MHZ-T3](#) [ABM3B1-25.000MHZ-D2Y-T](#) [SPT2A-.032768B](#) [SPT2A.032768G](#) [SSPT7F-9PF20-R](#) [LFXTAL065253Cutt](#) [LFXTAL066431Cutt](#) [XT9S20ANA14M7456](#) [XT9SNLANA16M](#) [7A-24.576MBBK-T](#) [7B-30.000MBBK-T](#) [MMCC2R32.7680KHZ](#) [7A-14.31818MBBK-T](#) [6504-202-1501](#) [6526-202-1501](#) [ABLS-12.000MHZ-B2Y-T](#) [7A-10.000MBBK-T](#) [SG636PCE-20.000MC](#) [3404](#) [E1SAA18-25.000M TR](#) [CM315D32768EZFT](#) [C1E-24.000-7-2020-R](#) [C1E-19.200-12-1530-X-R](#) [C1E-16.000-12-1530-X-R](#) [ABM11-16.000MHZ-9-B1U-T](#) [FL5000014](#) [EUCA18-3.1872M](#) [FX0800015](#) [425F35E027M0000](#) [FP0800018](#)