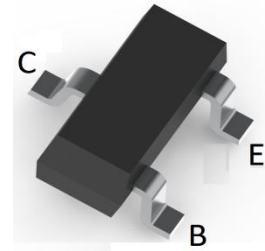
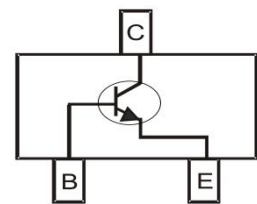

BIPOLAR TRANSISTOR (NPN)
FEATURES

- High DC current gain : $h_{FE}=200(\text{Typ})$ $V_{CE}=6\text{V}, I_C=1\text{mA}$
- High voltage: $V_{CEO}=50\text{V}$
- Surface Mount device
- Complementary to 2SA812

SOT-23

MECHANICAL DATA

- Case: SOT-23
- Case Material: Molded Plastic. UL flammability
- Classification Rating: 94V-0
- Weight: 0.008 grams (approximate)

MAXIMUM RATINGS ($T_A = 25^\circ\text{C}$ unless otherwise noted)

Parameter	Symbol	Value	Unit
Collector-Base Voltage	V_{CBO}	60	V
Collector-Emitter Voltage	V_{CEO}	50	V
Emitter-Base Voltage	V_{EBO}	5	V
Collector Current	I_C	100	mA
Collector Power Dissipation	P_C	200	mW
Thermal Resistance From Junction To Ambient	$R_{\theta JA}$	625	$^\circ\text{C}/\text{W}$
Junction Temperature	T_J	150	$^\circ\text{C}$
Storage Temperature	T_{STG}	-55 ~ +150	$^\circ\text{C}$

ELECTRICAL CHARACTERISTICS ($T_A = 25^\circ\text{C}$ unless otherwise specified)

Parameter	Symbol	Min	Typ	Max	Unit	Conditions
Collector-base breakdown voltage	$V_{(BR)CBO}$	60			V	$I_C=100\mu\text{A}, I_E=0$
Collector-emitter breakdown voltage	$V_{(BR)CEO}$	50			V	$I_C=1\text{mA}, I_B=0$
Emitter-base breakdown voltage	$V_{(BR)EBO}$	5			V	$I_E=100\mu\text{A}, I_C=0$
Collector cut-off current	I_{CBO}			0.1	μA	$V_{CB}=60\text{V}, I_E=0$
Emitter cut-off current	I_{EBO}			0.1	μA	$V_{EB}=5\text{V}, I_C=0$
DC current gain	h_{FE}	90	200	600		$V_{CE}=6\text{V}, I_C=1\text{mA}$
Collector-emitter saturation voltage	$V_{CE(sat)}$			0.3	V	$I_C=100\text{mA}, I_B=10\text{mA}$
Base-emitter saturation voltage	$V_{BE(sat)}$			1	V	$I_C=100\text{mA}, I_B=10\text{mA}$
Transition frequency	f_T		250		MHz	$V_{CE}=6\text{V}, I_C=10\text{mA}$

CLASSIFICATION OF h_{FE}

Rank	L4	L5	L6	L7
Range	90-180	135-270	200-400	300-600
Marking	L4	L5	L6	L7

BIPOLAR TRANSISTOR (NPN)

Typical Characteristics

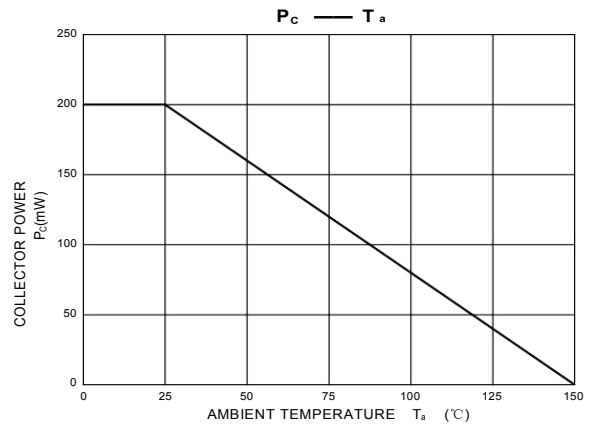
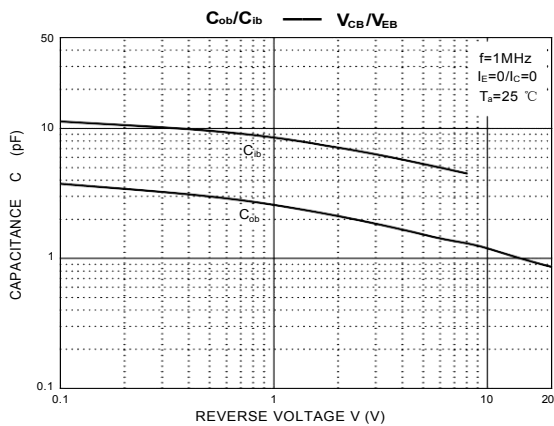
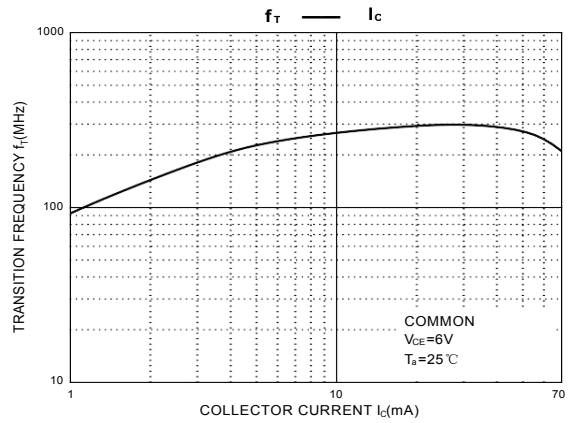
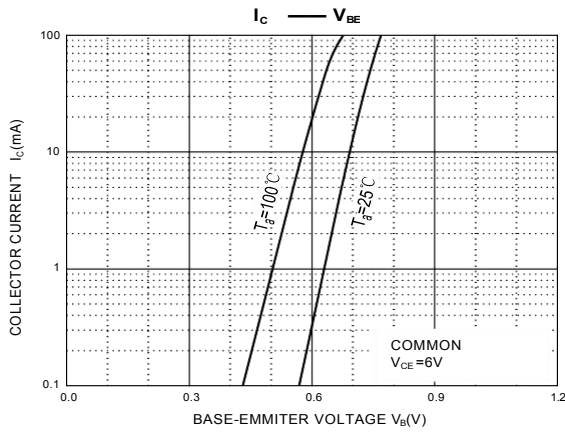
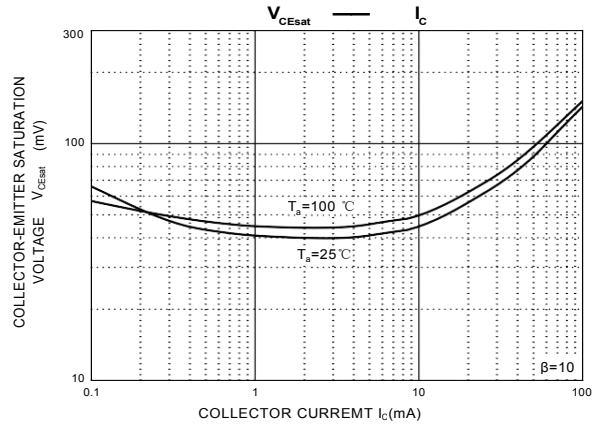
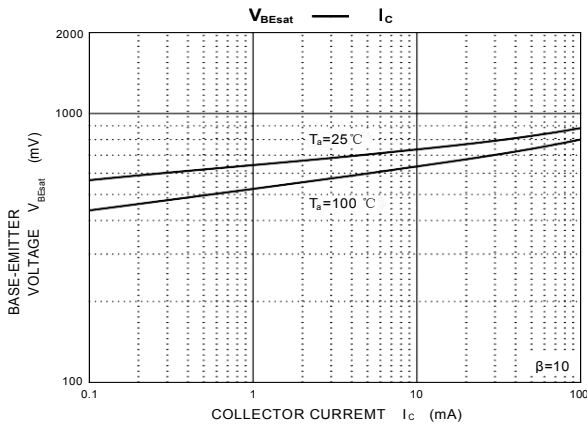
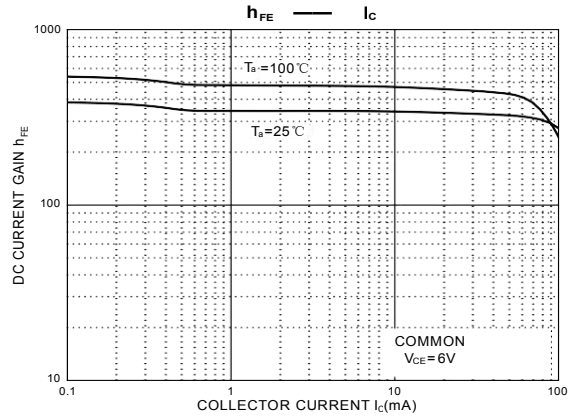
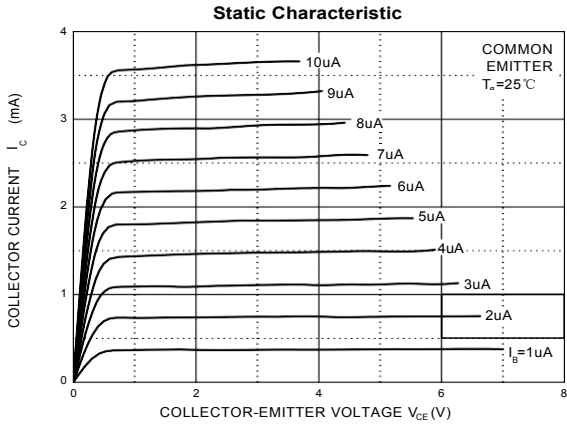

BIPOLAR TRANSISTOR (NPN)

SOT-23 Package Outline Dimensions

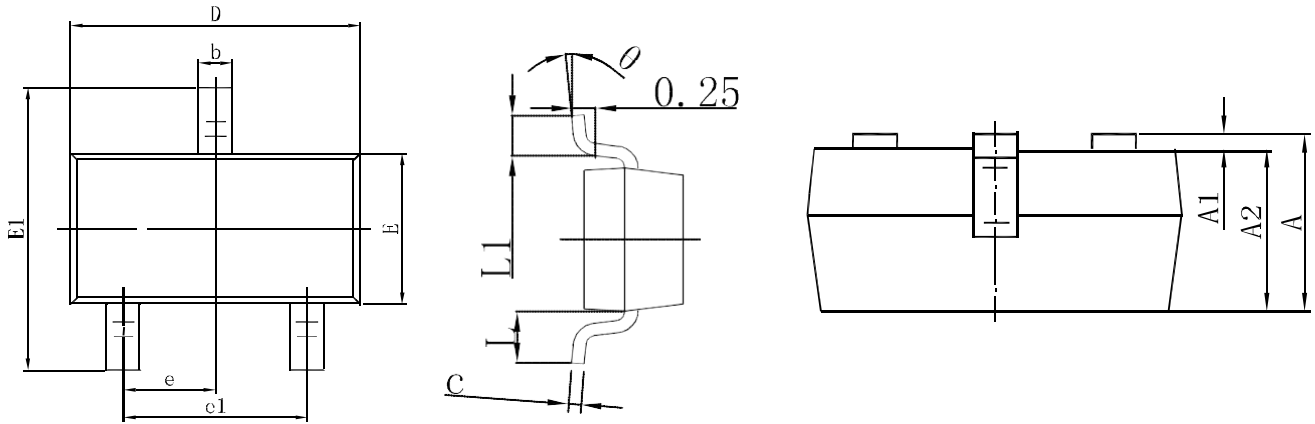

Symbol	Dimensions In Millimeters		Dimensions In Inches	
	Min.	Max.	Min.	Max.
A	0.900	1.150	0.035	0.045
A1	0.000	0.100	0.000	0.004
A2	0.900	1.050	0.035	0.041
b	0.300	0.500	0.012	0.020
c	0.080	0.150	0.003	0.006
D	2.800	3.000	0.110	0.118
E	1.200	1.400	0.047	0.055
E1	2.250	2.550	0.089	0.100
e	0.950 TYP		0.037 TYP	
e1	1.800	2.000	0.071	0.079
L	0.550 REF		0.022 REF	
L1	0.300	0.500	0.012	0.020
θ	0°	8°	0°	8°

SOT-23 Suggested Pad Layout

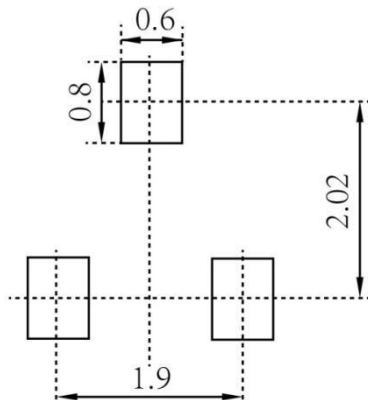

Note:

1. Controlling dimension: in millimeters
2. General tolerance: ±0.05mm
3. The pad layout is for reference purposes only

BIPOLAR TRANSISTOR (NPN)

SOT-23 Tape and Reel

SOT-23 Embossed Carrier Tape

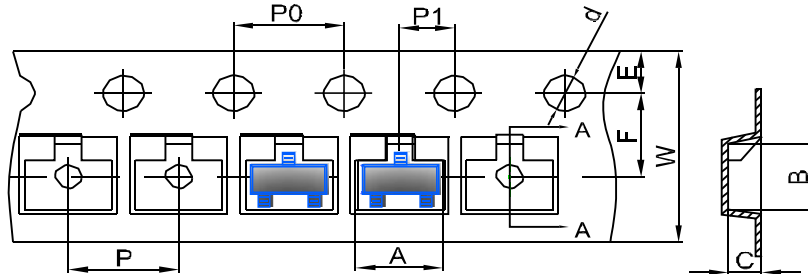

DIMENSIONS ARE IN MILLIMETER										
TYPE	A	B	C	d	E	F	P0	P	P1	W
SOT-23	3.15	2.77	1.22	Ø1.50	1.75	3.50	4.00	4.00	2.00	8.00
TOLERANCE	±0.1	±0.1	±0.1	±0.1	±0.1	±0.1	±0.1	±0.1	±0.1	±0.1

SOT-23 Tape Leader and Trailer

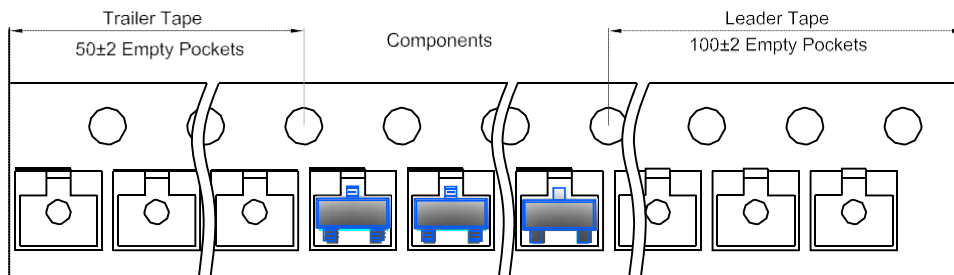

SOT-23 Reel

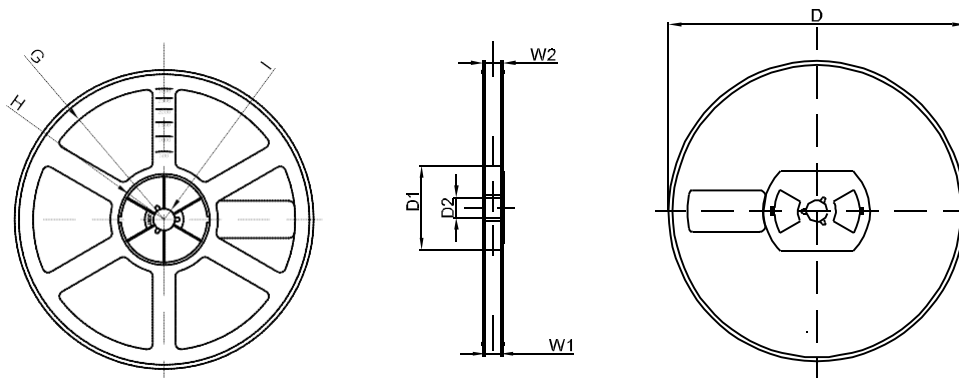

DIMENSIONS ARE IN MILLIMETER								
REEL OPTION	D	D1	D2	G	H	I	W1	W2
7" DIA	Ø178	54.40	13.00	R78	R25.60	R6.50	9.50	12.30
TOLERANCE	±2	±1	±1	±1	±1	±1	±1	±1

X-ON Electronics

Largest Supplier of Electrical and Electronic Components

Click to view similar products for [Bipolar Transistors - BJT category](#):

Click to view products by [Hottech manufacturer](#):

Other Similar products are found below :

[619691C](#) [MCH4017-TL-H](#) [MMBT-2369-TR](#) [BC546/116](#) [BC557/116](#) [BSW67A](#) [NJVMJD148T4G](#) [NTE123AP-10](#) [NTE153MCP](#) [NTE16](#)
[NTE195A](#) [NTE92](#) [C4460](#) [2N4401-A](#) [2N6728](#) [2SA1419T-TD-H](#) [2SA2126-E](#) [2SB1204S-TL-E](#) [2SC2712S-GR,LF](#) [2SC5488A-TL-H](#)
[2SD2150T100R](#) [SP000011176](#) [2N2907A](#) [2N3904-NS](#) [2N5769](#) [2SC2412KT146S](#) [2SD1816S-TL-E](#) [CPH6501-TL-E](#) [MCH4021-TL-E](#)
[MJE340](#) [US6T6TR](#) [NJL0281DG](#) [732314D](#) [CPH3121-TL-E](#) [CPH6021-TL-H](#) [873787E](#) [IMZ2AT108](#) [UMX21NTR](#) [MCH6102-TL-E](#)
[NJL0302DG](#) [2N3583](#) [30A02MH-TL-E](#) [NSV40301MZ4T1G](#) [NTE13](#) [NTE26](#) [NTE282](#) [NTE323](#) [NTE350](#) [NTE81](#) [STX83003-AP](#)